

NEW PRODUCTS

5PC MEASURING & MARKING SET

- Made of hardend tool steel.
- **Set consists of one of each:**
 - Machinest Square: 6" (6" Blade x 4" Beam)
 - Center Finder Square: 1-1/2"
 - Round Head Protractor
 - Carbide Tipped Scriber with magnet other side.
 - Center Punch: 4"
- Complete in a fitted ABS case



5PC SET
4906-0105
\$ **69.50**
(F)

Additional Products Shown on Page 60.

11PC R8 COLLET SET & 12PC R8 COLLET RACK COMBO

11 Piece R8 Collet Set - 1/8-3/4" x 16ths (3900-0007)

- Hardened and precision ground to close tolerance.
- Made of high grade tool steel.
- Run out is 0.0007".
- Internally threaded: 7/16"-20.



R8 12 Piece Collet Rack (3900-0016)

- Open and close cover protects collets from debris.
- Mounting bolts are included.
- Easy side mount with two screws.

4951-0008
\$ **90.09**
(F)

Additional Collets Shown on Page 205.

HSS TAPER SHANK DRILLS 118° SPLIT POINT

- Designed for drilling in many different materials and a wide range of applications. These drills feature a surface treatment to improve chip flow and a taper shank made to American National Standard (Morse) dimensions. Black oxide finish for increased wear resistance and improved lubricity, reducing chip welding and galling.



Item#	Dia. d1	Flute Length l2	Shank Taper	OAL l1	Price (F)
5302-2024	3/8	3-1/2	2MT	7-3/8	5.16
5302-2040	5/8	4-7/8	2MT	8-3/4	7.39
5302-2048	3/4	5-7/8	2MT	9-3/4	9.86
5302-3056	7/8	6-1/8	3MT	10-3/4	14.11
5302-3100	1	6-3/8	3MT	11	19.06
5302-3108	1-1/8	7-1/8	3MT	11-3/4	25.22
5302-3116	1-1/4	7-7/8	3MT	12-1/2	38.74
5302-4116	1-1/4	7-7/8	4MT	13-1/2	38.74
5302-4124	1-3/8	8-7/8	4MT	14-1/2	46.13
5302-4132	1-1/2	9-3/8	4MT	15	61.67
5302-4140	1-5/8	10	4MT	15-5/8	65.88
5302-4148	1-3/4	10-3/8	4MT	16-1/4	75.62
5302-4200	2	10-5/8	4MT	16-5/8	110.88

Additional Sizes Shown on Page 89.

3K REVOLVING HEAD KNURLING TOOLS

- Machined ground steel in shiny black finish.
- Knurls are hob cut from high speed steel and heat treated.
- Provided with one pair each of fine, medium and coaraw knurls.
- Replacement knurls are offered as a complete spare set for knurling tools.



Item#	Holder size W x H x L	Knurl Dimensions Dia. x Thickness x Hole	Price (F)
2220-0008	1/2 x 1-1/8 x 6-1/2"	3/4 x 3/8 x 1/4"	73.20
2220-0010	5/8 x 1-3/8 x 7-1/2"	3/4 x 3/8 x 1/4"	75.50

Additional Knurling Products Shown on Page 305.

MCLNR TOOL HOLDERS - RIGID CLAMP DESIGN -5° LEAD ANGLE • RIGHT HAND

TMCLNR

- 0° Relief

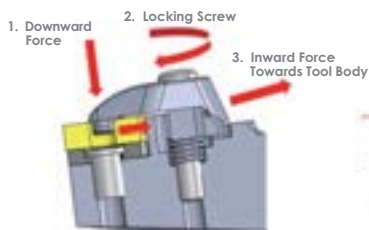

New Design!



INSERTS NOT INCLUDED

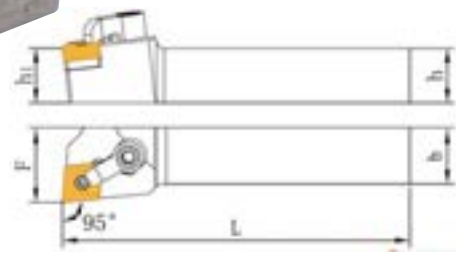

See page 152 for advantages.

See pages 165-166 for spare parts. Replacement inserts shown on pages 173-174.

Item #	Industry Ref. No.	Dimensions				Insert	Shim	Shim Screw	Clamp	Clamp Screw	Spring	Key	Price (F)
		h=h1	Shank Dia. b	Offset F	OAL L								
2011-1122	TMCLNR12-4B	3/4"	3/4"	1.00"	4.5"	CN...43.	C0903B	LYM0610	TP-2	MS0523	YB6512	S3	64.56
2011-1162	TMCLNR16-4D	1"	1"	1.25"	6"	CN...43.	C0903B	LYM0610	TP-2	MS0523	YB6512	S3	75.10
2011-1167	TMCLNR16-5D	1"	1"	1.25"	6"	CN...54.	C1604B	LYM0810	TP-4	MS0523	YB6512	S3	83.73
2011-1202	TMCLNR20-5E	1-1/4"	1-1/4"	1.50"	7"	CN...54.	C1604B	LYM0810	TP-4	MS0523	YB6512	S4	104.33

Additional Tool Holders Shown on Pages 153-164.

THREAD DETECTIVE/IDENTIFIER - Inch & Metric

- Nut and bolt thread identifier. Each size has a nut and bolt checker on the same gauge.
- Inch nut and bolt sizes include #6-32, #8-32, #10-32, #10-24, 1/4-28, 1/4-20, 5/16-24, 5/16-18, 3/8-24, 3/8-16, 7/16-20, 7/16-14, 1/2-20 & 1/2-13
- Metric Nut and bolt sizes include M4x0.7, M5x0.8, M6x1.0, M7x1.0, M8x1.0, M8x1.25, M10x1.0, M10x1.25, M10x1.50, M12x1.25, M12x1.50 & M12x1.75
- Thread sizes are etched on each gauge
- The individual gauges rotate freely on the wire cable for fast thread verification
- Wire cable with loop for convenient hanging



4901-0035
\$2945
(F)

Additional Internal Gaging Products Shown on Pages 30-38.

Dasqua® METRIC OUTSIDE MICROMETERS

- Strictly made in accordance with DIN 863.
- With ratchet stop for constant pressure.
- Spindle thread hardened, ground and lapped for ultimate accuracy.
- Clear graduations laser-etched on satin chrome finish for easy reading.
- With spindle lock.
- Carbide measuring surfaces ground for longer service life.
- Standards included above 0-1" micrometer.
- Fitted case.



3PC Set
0-75mm Range
4111-8206
\$13255
(F)

.01MM GRADUATION

Item#	Range	Accuracy	Price (F)
4111-8105	0-25mm	0.004"	36.95
4111-8110	25-50mm	0.004"	46.77
4111-8115	51-75mm	0.004"	50.73

Additional Micrometers Shown on Pages 17-23.

Dasqua® DIAL INDICATOR WITH MAGNETIC BACK

- Indicator strictly made in accordance with DIN 878.
- Permanent powerful magnet.
- Fitting for all group 2 dial indicator.
- Magnet screws off.
- Magnetic force: 20KG.
- Fitted case.



GROUP 2

Magnetic Back Only
5111-1010
\$985
(F)

5111-1010 Shown

Magnetic Back with Indicator Kits

Item#	Indicator Included	Indicator Range	Graduation	Stem Dia.	Price (F)
5111-0001	5111-0000	0-10mm	0.01mm	8mm	50.39
5122-4211	5111-4210	0-1"	0.001"	3/8"	44.14

Additional Indicators Shown on Pages 47-51.

60PC HSS METRIC/INCH TAP & DIE SET

- NC, NF and NPT threads
- 1" O.D. dies
- Adjustable die stock
- Adjustable handle tap wrench
- T-handle tap wrench
- Screwdriver
- Two screw pitch gages



CARBON STEEL

60PC SET
1011-0106
\$11595
(F)

INCLUDES:

27 tap & die sizes: 1/4-20NC, 5/16-18NC, 3/8-16NC, 7/16-14NC, 1/2-13NC, 4-40NC, 6-32NC, 8-32NC, 10-24NC, 12-24NC, 1/4-28NF, 5/16-24NF, 3/8-24NF, 7/16-20NF, 1/2-20NF, 10-32NF, 1/8-27NPT, 3mmx0.5, 4mmx0.7, 5mmx0.8, 6mmx1.0, 7mmx1.0, 8mmx1.25, 9mmx1.25, 10mmx1.5, 10mmx1.0, and 12mmx1.75.

Additional Sets Shown on Pages 99-101.

HARLINGEN® 3-JAW SELF-CENTERING LATHE CHUCKS - PLAIN BACK



- 2 sets of jaws
- Lathe chuck wrench and
- 1 set of mounting screws included



See page 284 for Advantages!

Item#	D	Center Hole	Max. Speed r/min	Price (F)
9712-1105	3"	0.63"	4000	133.41
9712-1106	4"	0.87"	3500	144.27
9712-1107	5"	1.18"	3000	163.35
9712-1108	6"	1.57"	2500	236.66
9712-1109	8"	2.56"	2000	290.68

Additional Chucks Shown on Pages 285-295.

TRIANGULAR HOLLOW SCRAPER

- An extremely useful accessory for scraping, trimming and deburring metals, tubing and other materials.
- Hollow ground cutting edge stays sharper longer and resharpen easily.



2001-0210
\$695
(F)

Additional Deburring Products Shown on Pages 107-108.

DIGITAL ELECTRONIC CALIPERS

3-KEY AUTO-OFF DIGITAL ELECTRONIC CALIPERS



**INCH/METRIC
.0005" RESOLUTION**

**0~6" Range
4100-0030
\$2967
(F)**

- Auto power off or manual on/off key.
- Three-key Model: Inch/MM, On/Off & Zero.
- Switchable inch/metric, with resolution to .0005"/.01mm on high contrast easy to read LCD display.
- 4-way measurements: Outside, Inside, Depth & Step.
- Floating zero.
- Body and measuring surfaces are hardened stainless steel.
- Standard SR 44, 1.55V battery included.
- With fitted case.
- Meets DIN 862.

REPLACEMENT BATTERY (ITEM #4102-0030)....\$3.19

Item#	Range	Accuracy	Price (F)
4100-0029	0-4" / 0-100mm	± 0.001"/ 0.02mm	45.97
4100-0030	0-6" / 0-150mm	± 0.001"/ 0.02mm	29.67
4100-0031	0-8" / 0-200mm	± 0.001"/ 0.03mm	57.11
4100-0032	0-12" / 0-300mm	± 0.0015"/ 0.04mm	71.55

Dasqua® METAL HOUSING BIG SCREEN DIGITAL ELECTRONIC CALIPERS



**0~6" Range
2117-9105
\$5554
(F)**

- Stainless steel frame.
- Silky smooth movement throughout.
- Hardened, ground and lapped measuring surfaces.



**INCH/METRIC
.0005" RESOLUTION**

REPLACEMENT BATTERY (ITEM #4102-0032)....\$3.32

Item#	Range	Reading	(mm)					Accuracy	Price (F)
			A	B	C	D	L		
2117-9105	0-6"/0-150mm	0.01mm/0.0005"	40	20	15.5	16	235	0.02mm/0.001"	55.54
2117-9110	0-8"/0-200mm	0.01mm/0.0005"	50	24	19.5	16	287	0.03mm/0.0015"	87.44
2117-9115	0-12"/0-300mm	0.01mm/0.0005"	60	26	21.5	16	290	0.03mm/0.0015"	130.52

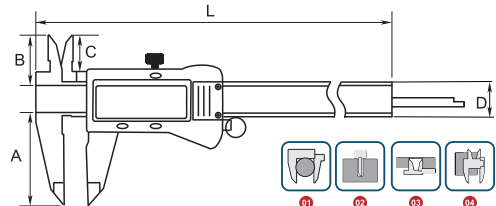

Z-Limit ULTRA SERIES DIGITAL ELECTRONIC CALIPERS



- Manufactured and inspected at world class factory that produces the highest quality US brands.
- Last measuring position retained when shut off
- 4-way measurements: Outside, Inside, Depth & Step
- Body is hardened stainless steel
- Automatic shut-off after 5 minutes of non-use
- Three-key Model: Inch/MM, On/Off & Zero
- Standard CR-2032(3V) battery included
- With thumb roller
- Meets DIN 862

**0~6" Range
4109-0030
\$7779
(F)**



Item#	Range	Accuracy	Price (F)
4109-0030	0-6"/0-150mm	.001"/.01mm	77.79
4109-0031	0-8"/0-200mm	.001"/.01mm	102.67
4109-0032	0-12"/0-300mm	.0015"/.04mm	157.40

**INCH/METRIC
.0005" / .01mm GRADUATION**

REPLACEMENT BATTERY (ITEM #4102-0032)....\$3.32

DIGITAL ELECTRONIC CALIPERS

Fraction/Inch/Metric DIGITAL ELECTRONIC CALIPERS



- Reads in fraction of an inch, easy to read.
- Resolution 0.0005"/0.01mm/1/64th
- Press button to change mode mm/inch/fractional
- 4-way measurements: Outside, Inside, Depth & Step.
- Standard SR 44, 1.55V battery included.
- On/off switch and auto off
- Zero setting
- With fitted case.
- Meets DIN 862

0-6" Range
4100-3506
\$33.59 (F)

.0005" INCH/METRIC RESOLUTION

REPLACEMENT BATTERY (ITEM #4102-0030)....\$3.19

Item#	Range	Accuracy	Price (F)
4100-3506	0-6"/0-150mm	.001"/.02mm	33.59
4100-3508	0-8"/0-200mm	.001"/.03mm	51.12
4100-3512	0-12"/0-300mm	.0015"/.04mm	72.20

Dasqua® BIG SCREEN DIGITAL ELECTRONIC CALIPER



- Surfaces of beam ground (Parallelism: 0.015, 20% better than normal) to ensure smooth movement throughout.
- Special glass etching for super accuracy.
- Digit Size: 11.5mm.
- Inch, Metric, Fractional.
- Standard CR-2032 (3V) battery included.
- Meets DIN 862.

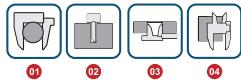

REPLACEMENT BATTERY (ITEM #4102-0032)....\$3.32

Item#	Range	Reading	(mm)					Accuracy	Price (F)
			A	B	C	D	L		
1804-1065	0-6"/0-150mm	0.01mm/0.0005"	40	20	15.5	16	235	0.02mm/0.001"	44.93

Dasqua® DIGITAL ELECTRONIC CALIPERS

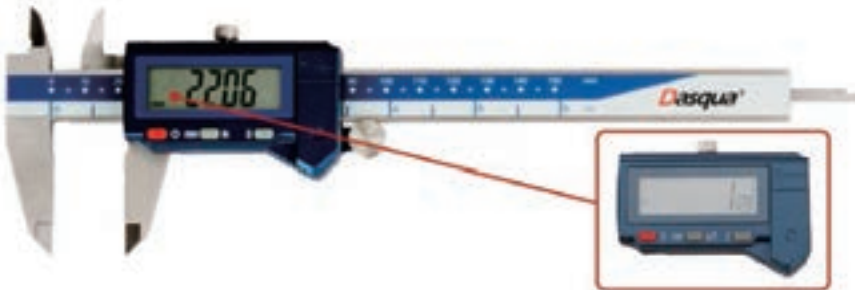

- NEW Advanced design.
- Strictly made in accordance with DIN862.
- Silky smooth movement throughout.
- Hardened, ground and lapped measuring surfaces.

REPLACEMENT BATTERY (ITEM #4102-0032).....\$3.32

Item#	Range	Reading	(mm)					Accuracy	Price (F)
			A	B	C	D	L		
9020-1005	0-6"/0-150mm	0.01mm / 0.0005" / 1/128"	40	20	15.5	16	235	0.02mm/0.001"	60.55
2000-1010	0-8"/0-200mm	0.01mm / 0.0005" / 1/128"	50	24	19.5	16	287	0.03mm/0.0015"	93.29
2000-1015	0-12"/0-300mm	0.01mm / 0.0005" / 1/128"	60	26	21.5	16	390	0.03mm/0.0015"	126.33

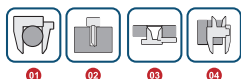

DIGITAL ELECTRONIC CALIPERS

4-KEY DIGITAL ELECTRONIC CALIPERS



0-6" Range
4100-3006
\$34.99 (F)

- Four-key type: Hold-key, On/Off key, Inch/mm key & Zero key. Enter high/low dimensional limits-out of limits will flash on display.
- Body is hardened stainless steel.
- 4-way measurement for outside, inside, depth and step.
- Thumb roller for moving the slider in small and smooth increments.
- Hold-key can be used for data hold at any position.
- Standard SR 44, 1.55V battery included.
- With fitted case.
- Meets DIN 862

.0005"/0.01mm INCH/METRIC RESOLUTION

REPLACEMENT BATTERY (ITEM #4102-0030)....\$3.19

Item#	Range	Accuracy	Price (F)
4100-3006	0-6" /0-150mm	± .001"/.02mm	34.99
4100-3008	0-8" /0-200mm	± .001"/.03mm	78.27
4100-3012	0-12" /0-300mm	± .0015"/.04mm	102.13

Dasqua® ABSOLUTE IP54 WATER RESISTANT DIGITAL ELECTRONIC CALIPERS



- IP54 protection against water, oil, dust or any other liquid.
- Hardened stainless steel blade for long life.
- Silky smooth movement throughout.
- Fitted case.

Absolute function NEW and GREAT for precision inspection:

All Dasqua digital calipers with this logo "Absolute" are equipped with the innovative Absolute-Reference System. The zero position just needs to be set once: After setting the zero position, the zero remains memorized for all further measurements. Therefore, once the caliper is switched ON or the slider is moved, the caliper is immediately ready for measurement.

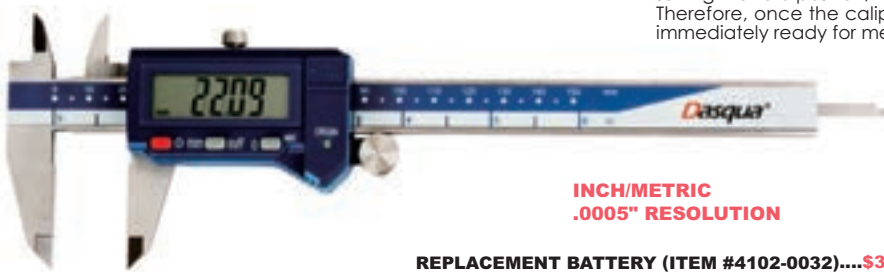

REPLACEMENT BATTERY (ITEM #4102-0032)....\$3.32

Item#	Range	Reading	(mm)					Accuracy	Price (F)
			A	B	C	D	L		
2010-1005	0-6"/0-150mm	0.01mm / 0.0005"	40	20	15.5	16	235	0.02mm/0.001"	74.23
2010-1010	0-8"/0-200mm	0.01mm / 0.0005"	50	24	19.5	16	287	0.03mm/0.0015"	104.03
2010-1015	0-12"/0-300mm	0.01mm / 0.0005"	60	26	21.5	16	390	0.03mm/0.0015"	143.00

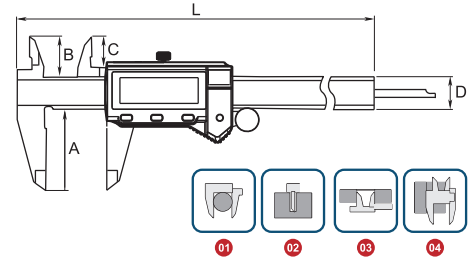

FLIP OVER DIGITAL ELECTRONIC CALIPERS

- Display flips 180° with display rotation function for true left handed operation.
- Can also be positioned for top viewing
- 4-way measurements: OD, ID, Depth and Step.
- Body is hardened stainless steel.
- Thumbroll for smooth measuring.
- True inch/metric conversion.
- Floating zero.
- Standard CR-2032 (3V) battery included.
- With fitted case.



INCH/METRIC .0005"/0.01mm RESOLUTION



REPLACEMENT BATTERY (ITEM #4102-0032)....\$3.32

Item#	Range	Accuracy	Battery	Price (F)
4100-3216	0-6"/0-150mm	.001"/.02mm	CR-2032/3V	78.76
4100-3218	0-8"/0-200mm	.001"/.02mm	CR-2032/3V	117.41

Dasqua® IP67 WATER PROOF DIGITAL ELECTRONIC CALIPERS



- mm/in/F IP67
COOLANT & FLUID
RESISTANT
- DIN 862 Battery
+
CR2032

• The accuracy of both the upper and lower jaws are strictly controlled.

• Electronic components all perfectly sealed

• Strictly made in accordance with DIN862

- Inductive measurement system.
- A-class static protection.
- With calibration certificate.
- Hardened stainless steel blade for long life.
- mm/inch/fraction

• Solid stainless steel construction

**INCH/METRIC
.0005" RESOLUTION**

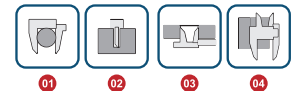
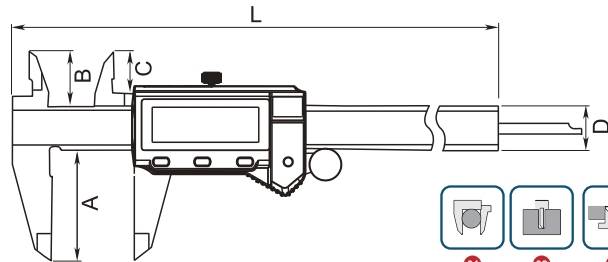

ACCESSORIES

Item#	Description	Price (F)
2140-9997	Wireless Transmitter/Receiver	144.27
2140-9998	Bluetooth Transmitter	48.07
2140-9999	Cable	112.03

Item#	Range	Reading	(mm)					Accuracy	Price (F)
			A	B	C	D	L		
2015-1005	0-6"/0-150mm	0.01mm / 0.0005" / 1/128"	40	20	15.5	16	235	0.02mm/0.001"	93.44
2015-1010	0-8"/0-200mm	0.01mm / 0.0005" / 1/128"	50	24	19.5	16	287	0.03mm/0.0015"	120.04
2015-1015	0-12"/0-300mm	0.01mm / 0.0005" / 1/128"	60	26	21.5	16	390	0.03mm/0.0015"	172.48

Dasqua® BUILT-IN BLUETOOTH IP54 WATER RESISTANT ABSOLUTE DIGITAL ELECTRONIC CALIPERS



- Strictly made in accordance with DIN862.
- IP54 protection against water, oil, dust or any other liquid.
- Silky smooth movement throughout.
- Hardened, ground and lapped measuring surfaces.

**INCH/METRIC
.0005" RESOLUTION**

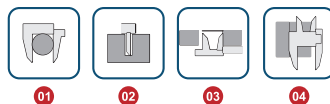

- Battery
+
CR2032 Wi-Fi DIN 862 mm/in/F IP54
COOLANT & FLUID
RESISTANT Absolute

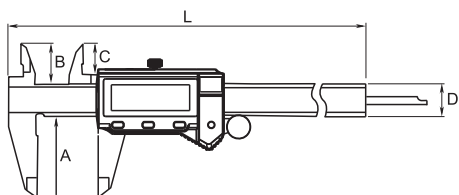

Item#	Range	Reading	(mm)					Accuracy	Price (F)
			A	B	C	D	L		
2025-1005	0-6"/0-150mm	0.01mm / 0.0005" / 1/128"	40	20	15.5	16	235	0.02mm/0.001"	101.17
2025-1010	0-8"/0-200mm	0.01mm / 0.0005" / 1/128"	50	24	19.5	16	287	0.03mm/0.0015"	135.41
2025-1015	0-12"/0-300mm	0.01mm / 0.0005" / 1/128"	60	26	21.5	16	390	0.03mm/0.0015"	173.76

DIGITAL ELECTRONIC CALIPERS

LONG RANGE DIGITAL ELECTRONIC CALIPERS

- Resolution to .0005"/.01mm on high contrast LCD display.
- Internal and external measurement.
- Absolute/Incremental measurement with fine adjustment.
- Body is hardened stainless steel, no-glare satin reading.
- Standard SR 44, 1.55V battery included.
- Switchable inch/metric.
- Preset function.
- On/Off button.
- With fitted wood case.
- Meets DIN 862

0~20" Range
4100-0033
\$323.80
(F)

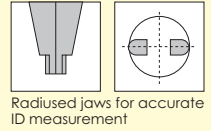

Radiused jaws for accurate ID measurement

**INCH/METRIC
.0005" RESOLUTION**

REPLACEMENT BATTERY (ITEM #4102-0030)....\$3.19
* Truck Ship Only

Item#	Range	Jaw Length	Radiused Jaw Width	Accuracy	Price (E)
4100-0033	0-20"/ 0-500mm	4	0.787"	± 0.002"/ 0.05mm	323.80
4109-1034	0-24"/ 0-600mm	4	0.80"	± 0.002"/ 0.05mm	246.30
4109-1036	0-40"/ 0-1000mm	5	0.80"	± 0.002"/ 0.06mm	555.80
4100-0037	0-60"/ 0-1500mm	5-1/4	0.787"	± 0.004"/ 0.10mm	1,132.30
4100-0038*	0-80"/ 0-2000mm	6	0.787"	± 0.004"/ 0.10mm	2,169.05

Dasqua® INDUSTRIAL HEAVY DUTY DIGITAL ELECTRONIC CALIPERS

Battery + CR2032 CABLE 03 DIN 862 mm/in Data output

- Strictly made in accordance with DIN862.
- With fine adjustment.
- With hold function.
- Hardened stainless steel construction for long life.
- Metric/Inch conversion.

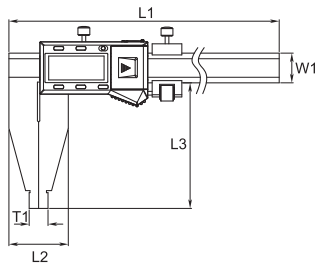

Competitive Price compared to other industrial-grade heavy duty calipers

**INCH/METRIC
.0005" RESOLUTION**

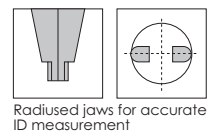
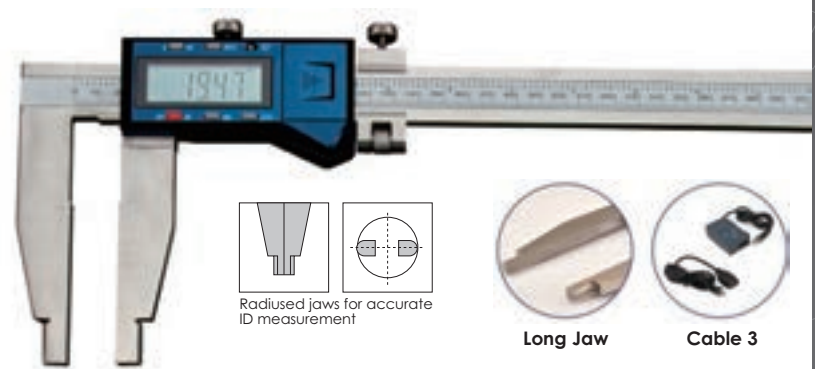

Radiused jaws for accurate ID measurement



Long Jaw



Cable 3

Item#	Range	Reading	(mm)						Accuracy	Price (F)
			L1	L2	L3	W1	T1			
2220-8113	0-12"/0-300mm	0.01mm / 0.0005"	445	40	90	20	12.7	0.04mm/0.002"	155.45	
2220-8116	0-24"/0-600mm	0.01mm / 0.0005"	770	44	100	24	20.32	0.05mm/0.002"	264.65	
2220-8119	0-40"/0-1000mm	0.01mm / 0.0005"	1210	46	125	30	20.32	0.06mm/0.0025"	595.50	

Table 3 (ITEM #2220-9999).....\$81.95

Pro-Series LONG RANGE DIGITAL ELECTRONIC CALIPERS



Limited Supply!

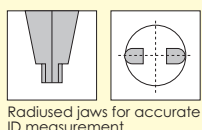

Radiused jaws for accurate ID measurement

0~20" Range
4100-0233
\$367.86
(E)

- Manufactured and inspected at world class factory that produces highest quality US brands.
- Switchable inch/metric.
- High contrast LCD display.
- Preset function.
- On/Off button.
- Internal and external measurement.
- Absolute/Incremental measurement with fine adjustment.
- Body is hardened stainless steel, no-glare satin reading.
- Standard CR-2032, 3V battery included.
- With fitted case.
- Meets DIN 862

**INCH/METRIC
.0005" / .01MM RESOLUTION**

REPLACEMENT BATTERY (ITEM #4102-0032)....\$3.32

Item#	Range	Jaw Length	Radiused Jaw Width	Accuracy	Price (E)
4100-0233	0-20"/ 0-500mm	4"	0.787"	± .001"/ .02mm	367.86
4100-0234	0-24"/ 0-600mm	4"	0.787"	± .0015"/ .03mm	465.38
4100-0236	0-40"/ 0-1000mm	6"	0.787"	± .002"/ .05mm	689.60

Dasqua® IP54 WATER RESISTENT LONG RANGE DIGITAL ELECTRONIC CALIPERS

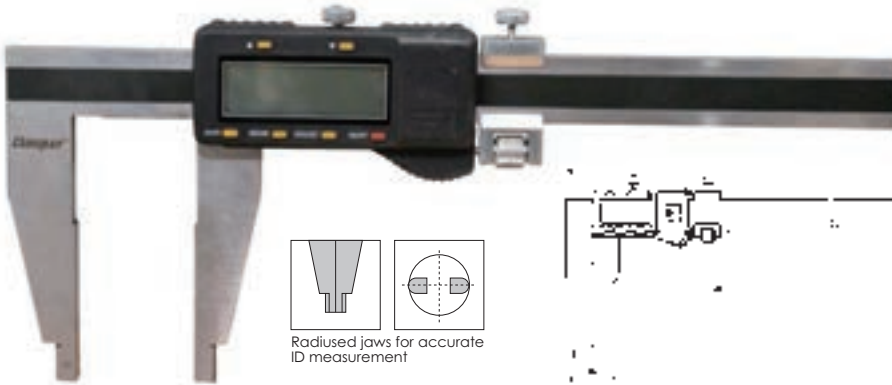

Radiused jaws for accurate ID measurement

IP54 COOLANT & FLUID RESISTANT
Data output
DIN 862
mm/in
Battery CR2032

- With sturdy frame and big size for high stability.
- Made of solid stainless steel.
- Strictly made in accordance with DIN862.
- With fine adjustment.
- With Data-Output and Metric-Inch Conversion function.

REPLACEMENT BATTERY (ITEM #4102-0030)....\$3.19

Item#	Range	Resolution	(mm)					Accuracy	Price (F)
			L	A	B	W	T		
2220-3575	0-60"/0-1500mm	0.01mm / 0.0005"	1800	80	125	41.5/52	20	0.11/0.0045"	1,739.87
2220-3580	0-80"/0-2000mm	0.01mm / 0.0005"	2300	80	150	41.5/52	20	0.14/0.0055"	2,751.16

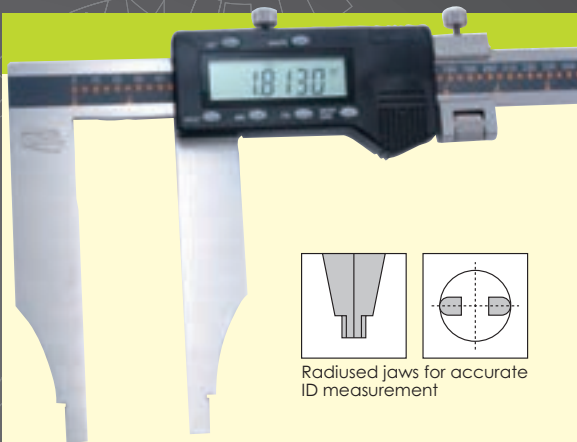

Radiused jaws for accurate ID measurement

Z-Limit LONG-JAW DIGITAL ELECTRONIC CALIPERS

- Manufactured and inspected at world class factory that produces highest quality US brands.
- Internal and external measurement.
- Absolute/Incremental measurement with fine adjustment.
- Body is hardened stainless steel , no-glare satin reading.
- Standard CR-2032, 3V battery included.
- Switchable inch/metric.
- High contrast LCD display.
- Preset function.
- On/Off button.
- With fitted case.
- Meets DIN 862



INCH/METRIC .0005" / .01MM RESOLUTION
REPLACEMENT BATTERY (ITEM #4102-0032)....\$3.32

Item#	Range	Jaw Length	Radiused Jaw Width	Accuracy	Price (F)
4109-0242	0-24"/ 0-600mm	6"	0.787"	± .0015"/ .03mm	573.67
4109-0243	0-24"/ 0-600mm	8"	0.787"	± .0015"/ .03mm	622.97

Dasqua® IP54 WATER PROOF HEAVY DUTY DIGITAL ELECTRONIC CALIPERS-WITH UPPER JAWS



INCH/METRIC .0005" RESOLUTION

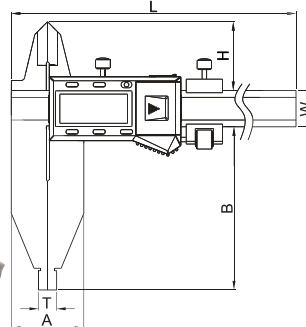

IP54 COOLANT & FLUID RESISTANT
Data output
DIN 862
mm/in
Battery CR2032

- With sturdy frame and big size for high stability.
- Made of solid stainless steel.
- Strictly made in accordance with DIN862.
- With fine adjustment.
- With Data-Output and Metric-Inch Conversion function.

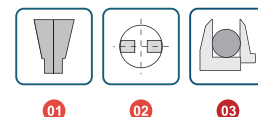

Item#	Range	Reading	(mm)						Accuracy	Price (F)
			L	A	B	W	T	H		
2710-1105	0-12"/0-300mm	0.01mm / 0.0005"	445	40	90	20	10	38	0.04mm/0.002"	194.55
2710-1110	0-20"/0-500mm	0.01mm / 0.0005"	670	52	150	24	20	60	0.05mm/0.002"	332.08
2710-1113	0-24"/0-600mm	0.01mm / 0.0005"	770	54	150	24	20	60	0.05mm/0.002"	347.55
2710-1115	0-40"/0-1000mm	0.01mm / 0.0005"	1210	60	150	30	20	63	0.06mm/0.0025"	767.14

DIAL CALIPERS

PRECISION DIAL CALIPERS

- Covered rack for longer life and chip free operation.
- 4-way measurement for outside, inside, depth and step.
- Adjustable dial for easy reading.
- One revolution
- Positive lock.
- Fitted case.
- Meets DIN 862.

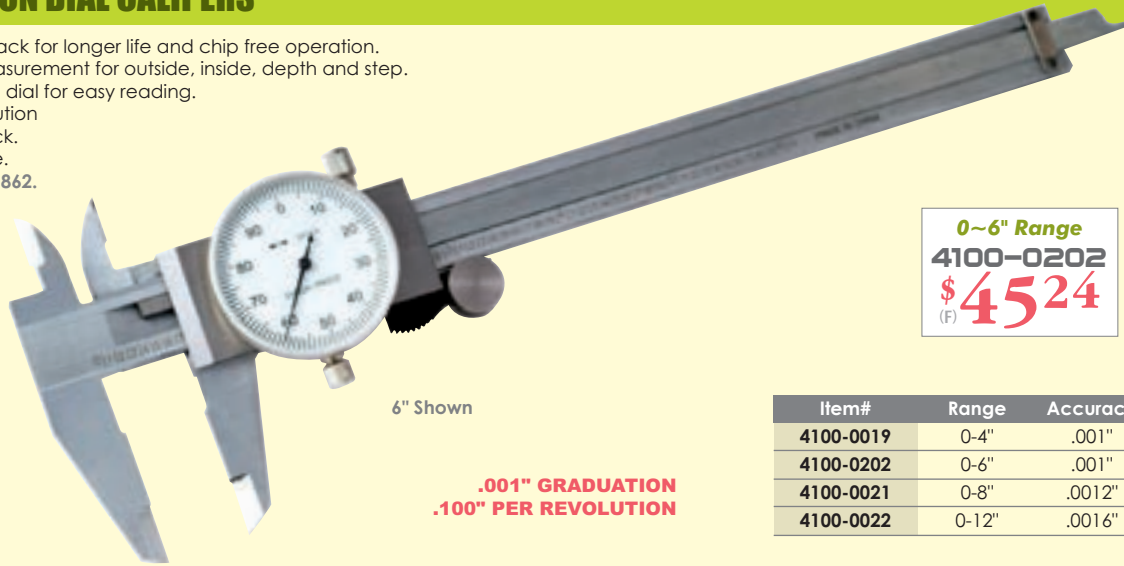

6" Shown

**.001" GRADUATION
.100" PER REVOLUTION**

0~6" Range
4100-0202
\$ **45.24**
(F)

Item#	Range	Accuracy	Price (F)
4100-0019	0-4"	.001"	60.97
4100-0202	0-6"	.001"	45.24
4100-0021	0-8"	.0012"	54.34
4100-0022	0-12"	.0016"	98.83

Pro-Series PRECISION DIAL CALIPER

- Direct reading, reliable and accurate.
- Graduations of .001" in one revolution.
- Hardened stainless steel bar, rack, gears, depth rod and measuring faces.
- Screw on rack, covered for chip free operation.
- Shock proof.
- Knife-edge contacts for both inside and outside measurements.
- 4-way measurements: inside, outside, depth and step.
- Lock screw for holding the sliding jaw in position.

- One hand use with the thumb operated fine adjustment roller.
- Decimal, Fraction Conversion chart on back of caliper.
- Lock screw for knurled dial (1-1/2") bezel.
- With fitted case.
- Meets DIN 862

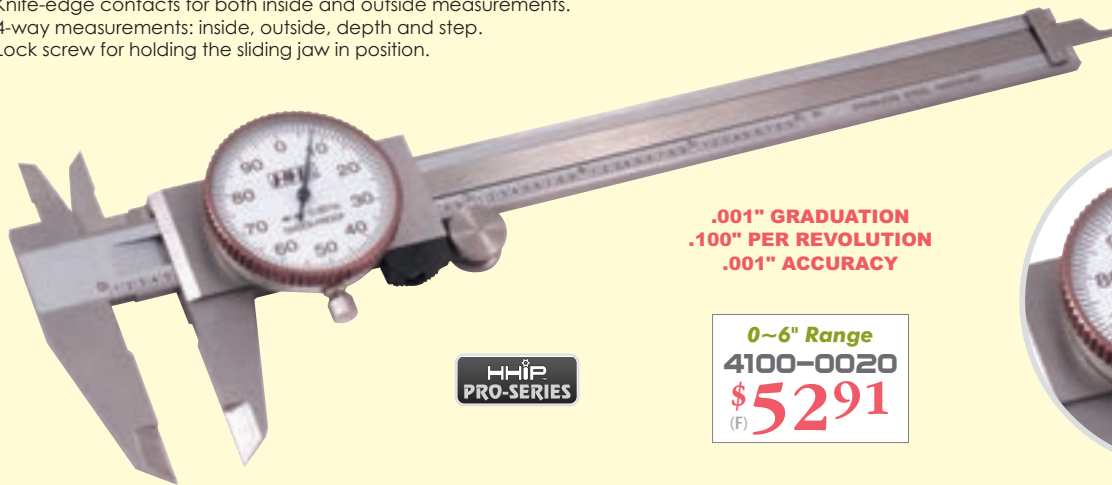

**HIP
PRO-SERIES**

**.001" GRADUATION
.100" PER REVOLUTION
.001" ACCURACY**

0~6" Range
4100-0020
\$ **52.91**
(F)

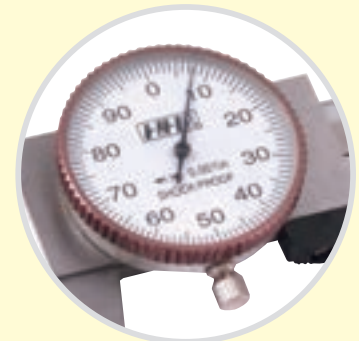

BLACK FACE PRECISION DIAL CALIPERS

- Covered rack for longer life and chip free operation.
- 4-way measurement for outside, inside, depth and step.
- Adjustable dial for easy reading.
- One revolution
- Positive lock.
- Fitted case.
- Meets DIN 862.

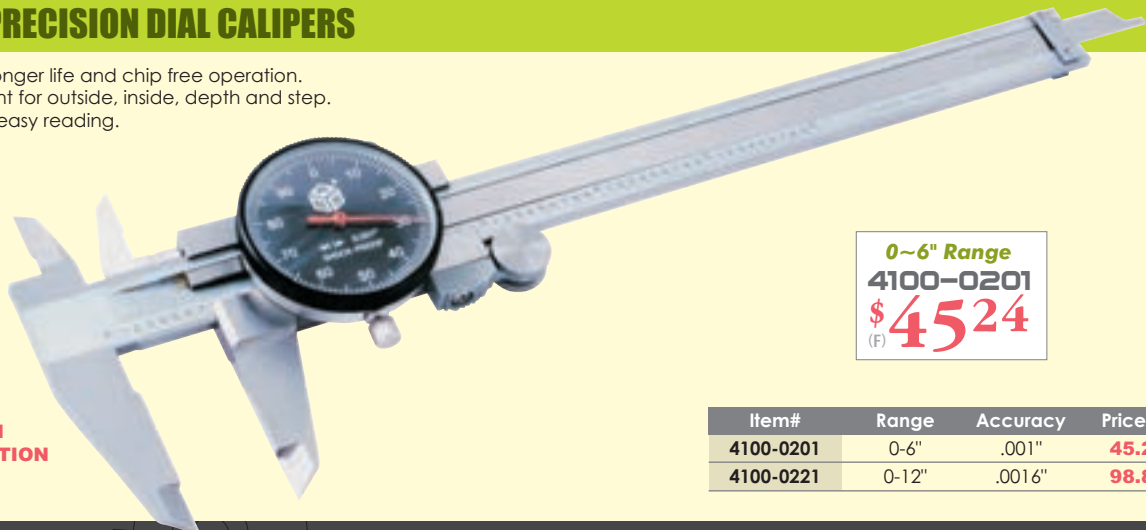

**.001" GRADUATION
.100" PER REVOLUTION**

0~6" Range
4100-0201
\$ **45.24**
(F)

Item#	Range	Accuracy	Price (F)
4100-0201	0-6"	.001"	45.24
4100-0221	0-12"	.0016"	98.83

Dasqua® MACHINIST GRADE SHOCK PROOF DIAL CALIPERS

DIN 862

SHOCK-PROOF



01



02



03



04

- The entire body jaws are vacuum hardened with uniform hardness, guaranteeing longer wear-resistance and longer service life.
- The upper and lower parts of the slide scale body are precisely ground to ensure smooth operation.
- Strictly in accordance with **DIN862** standard.
- Made of high quality stainless steel.

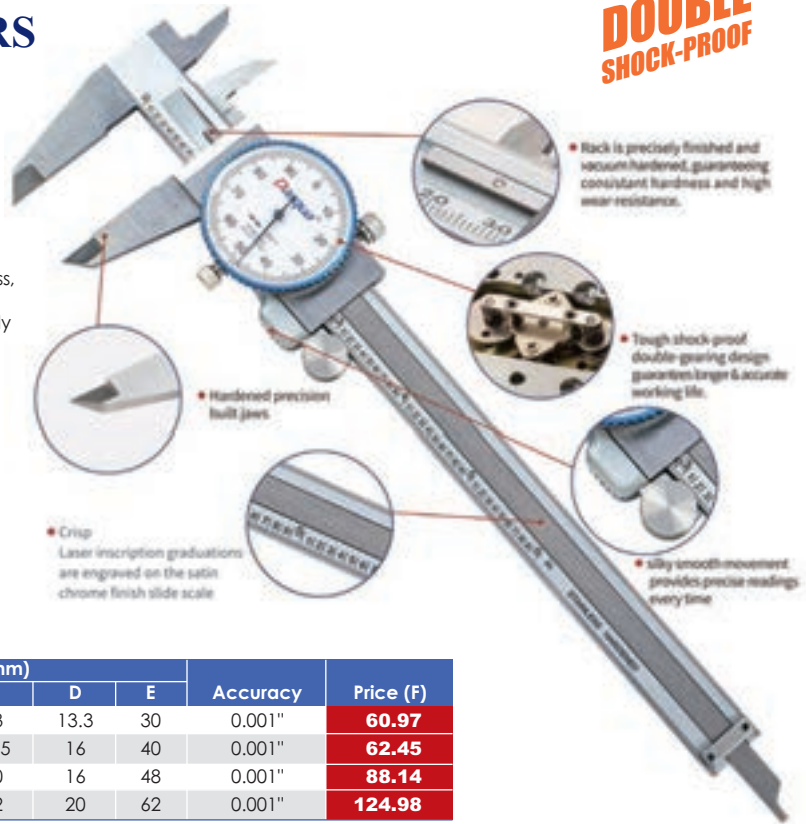
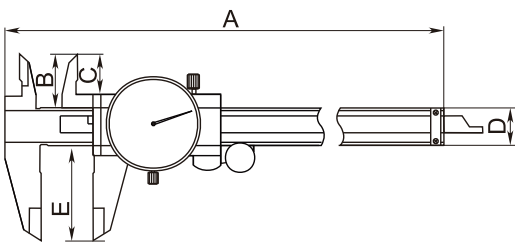

DOUBLE SHOCK-PROOF

• Rack is precisely finished and vacuum hardened, guaranteeing consistent hardness and high wear-resistance.

• Hardened precision built jaws

• Crisp Laser inscription graduations are engraved on the satin chrome finish slide scale

• Tough shock proof double-gearing design guarantees longer & accurate working life.

• Silky smooth movement provides precise readings every time

Item#	Range	Graduation	(mm)					Accuracy	Price (F)
			A	B	C	D	E		
1332-4105	0-4"	0.001"	169	18	13	13.3	30	0.001"	60.97
1332-4110	0-6"	0.001"	236	21	16.5	16	40	0.001"	62.45
1332-4115	0-8"	0.001"	285	24	20	16	48	0.001"	88.14
1332-4120	0-12"	0.001"	410	28	22	20	62	0.001"	124.98

Z-Limit ULTRA QUALITY SHOCK PROOF DIAL CALIPER

- Manufactured and inspected at world class factory that produces highest quality European brands.
- Graduations of .001" in one revolution.
- Hardened stainless steel very well finished.
- Smooth operating, Shockproof.
- Screw on rack.
- Knife-edge contacts for both inside and outside measurements.
- 4-way measurements: inside, outside, depth and step.
- One hand use with the thumb operated fine adjustment roller.
- With fitted durable case.
- Meets DIN 862



Limited Supply!

.001" GRADUATION
.001" ACCURACY
SMOOTH MOVEMENT

0~6" Range
4109-0006
\$6684
(F)

Z-Limit SHOCK PROOF DIAL CALIPERS WITH METAL HOUSING

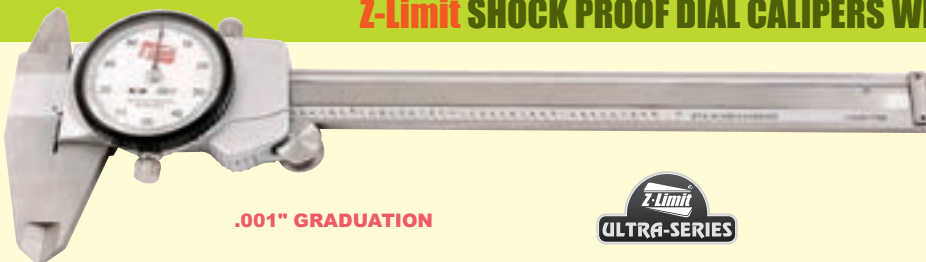

.001" GRADUATION

Z-Limit
ULTRA-SERIES



- Manufactured and inspected at world class factory that produces highest quality US brands.
- 4-way measuring: outside, inside, depth and step.
- Silky smooth movement throughout the entire range, tough, shockproof design.
- Stainless steel construction.
- .100" range per revolution.
- .001" reading dial face.
- Supplied in a shop-hardened case.

Limited Supply!

Item#	Range	Accuracy	Jaw Length	Price (F)
4109-2801	0-6"	.001"	1.6"	70.77
4109-2802	0-8"	.001"	2.0"	87.12
4109-2803	0-12"	.0015"	2.5"	135.52

LONG RANGE DIAL CALIPERS

Dasqua® LONG RANGE HEAVY DUTY SHOCK PROOF DIAL CALIPERS

SHOCK-PROOF **DIN 862**



- Tough shock-proof gearing.
- 4 usages for measuring outside diameter, inside diameter, step and depth.
- Solid stainless steel construction.
- Strictly made in accordance with DIN862.
- Distinct lines and figures laser etched against satin chrome finish.
- Locking screw for stable reading.
- Extra rigid main beam for high stability.
- Hardened, ground and lapped measuring surfaces.
- Silky smoothy movement throughout.
- Beam graduation in 0.100" increments.

**.100" PER REVOLUTION
.001" GRADUATION**

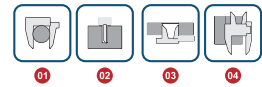
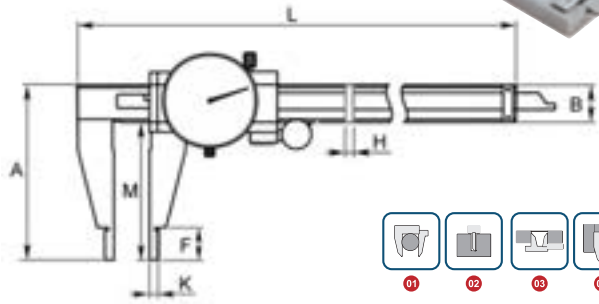

Item#	Range	Graduation	(mm)							Accuracy	Price (F)
			L	A	B	F	H	K	M		
1432-4105	0-18"	0.001"	580	108	22	20	6.0	5	86	±0.002"	249.52
1432-4110	0-20"	0.001"	630	108	22	20	6.0	5	86	±0.002"	313.66
1432-4115	0-24"	0.001"	730	108	22	20	6.0	5	86	±0.002"	334.57
1432-4120	0-40"	0.001"	1200	168	28	22	8.0	10	140	±0.0025"	662.61

PRECISION MEASURING TOOLS

Ultra-Series LONG RANGE DIAL CALIPERS

- Manufactured and inspected at world class factory that produces highest quality US brands.
- Made of stainless steel hardened and precision ground.
- One revolution per each 0.100"
- Covered screw-on rack made from one piece.
- 3-way measurement: Outside, Inside and Depth.
- Thumb roll for rapid measuring.
- Beam graduation in 0.100" increments stain chrome finished.
- With fitted case.
- Meets DIN 862

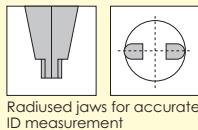

SMOOTH MOVEMENT

Item#	Range	Jaw Depth	Radiused Jaws Width	Accuracy	Price (F)
4100-2428	0-18"	4"	0.787"	.0028"	313.15
4100-2430	0-20"	4"	0.787"	.0030"	302.50
4100-2434	0-24"	4"	0.787"	.0038"	451.42



Limited Supply!

**.100" PER REVOLUTION
.001" GRADUATION**

CENTER LINE GAGE SETS

- Checks distance between different size hole, or to an edge from a hole. Cone will seek center.
- Adapts to most dial calipers.
- Reads in exact figures.
- High grade alloy steel.



Item#	For	Price (F)
4100-0040	4", 6", 8" Calipers	13.75
4100-0041	10", 12" Calipers	15.13

Z-Limit DEPTH MEASURING BASE FOR 6" CALIPERS

Slot width: .64"
Base width: 3"

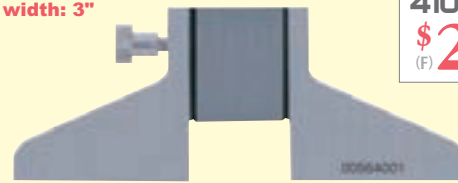

4109-0046
\$2001
(F)

CALIPER ACCESSORY KIT

- Components are hardened.
- 4.1mm slot to fit all kinds of brands.
- **Kit includes:**
4 sets of points
4 sets of screws
1 set of clamps
1 Allen wrench



4100-0044
\$2531
(F)

REPLACEMENT BATTERIES FOR DIGITAL ELECTRONIC CALIPERS

Battery height 5.40mm.
Battery diameter 11.60mm.



SR44, 1.55V
4102-0030
\$319
(F)



Battery height 3.2mm.
Battery diameter 20mm.

CG2032, 3V
4102-0032
\$332
(F)

CASES FOR CALIPERS (REPLACEMENT)

- Fits most dial and electronic calipers.
- Durable ABS material.
- **Case only.**



Item#	Fits Caliper	LxWxThick	Price (F)
4100-0030CASE	6"	9.8x3.5x1"	8.16
4100-0031CASE	8"	12.0x3.8x1"	9.33
4100-0032CASE	12"	16.7x4.9x1.1"	11.66

Pro-Series CASES FOR CALIPERS (REPLACEMENT)

- Fits most dial and electronic calipers.
- Durable ABS material.
- Modern & advanced design provides extra protection & depth accessory storage.
- **Case only.**



Item#	Fits Caliper	LxWxThick	Price (F)
4100-0030CV	6"	10.5x4x1.4"	9.43
4100-0031CV	8"	13x5x1.4"	10.58
4100-0032CV	12"	17X5.5X1.4"	13.75

VERNIER CALIPERS

PLASTIC VERNIER CALIPER

- Made from durable plastic material.
- 3-way measurement: Inside, outside and depth.
- Nice promotion item packed with blister card.
- Neon colors.

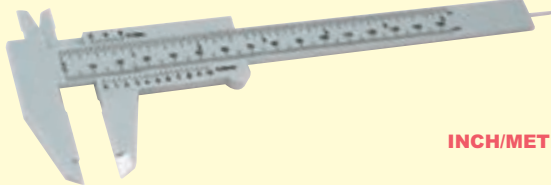

INCH/METRIC

Item#	Description	Graduation	Price (F)
4100-0001	0-6"/0-150mm	1/128"/ 0.05mm	3.03

PRECISION VERNIER CALIPER W/FINE ADJUSTMENT

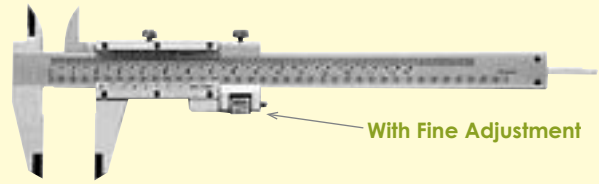

With Fine Adjustment

- Satin chrome finish: Non-glare.
- Measuring faces are ground.
- Supplied with case.

Limited Supply!

0~12"/0~300MM Range
4100-0005
\$4351
(F)

INCH/METRIC
.001"/ .02mm GRADUATION

Dasqua® VERNIER CALIPERS-LOCKING SCREW

DIN 862

- 4 usages for measuring outside diameter, inside diameter, step and depth.
- Made of solid stainless steel.
- Strictly made in accordance with DIN862.
- Distinct lines and figures etched against satin chrome finish.
- With locking screw for stable reading.
- Dual reading scales on vernier scale.
- Accuracy .0015"/.03mm.
- Ground and lapped measuring face provides wear resistance and long life.
- Raised sliding surface-helps prevent defacement of scale graduations.
- Case included.

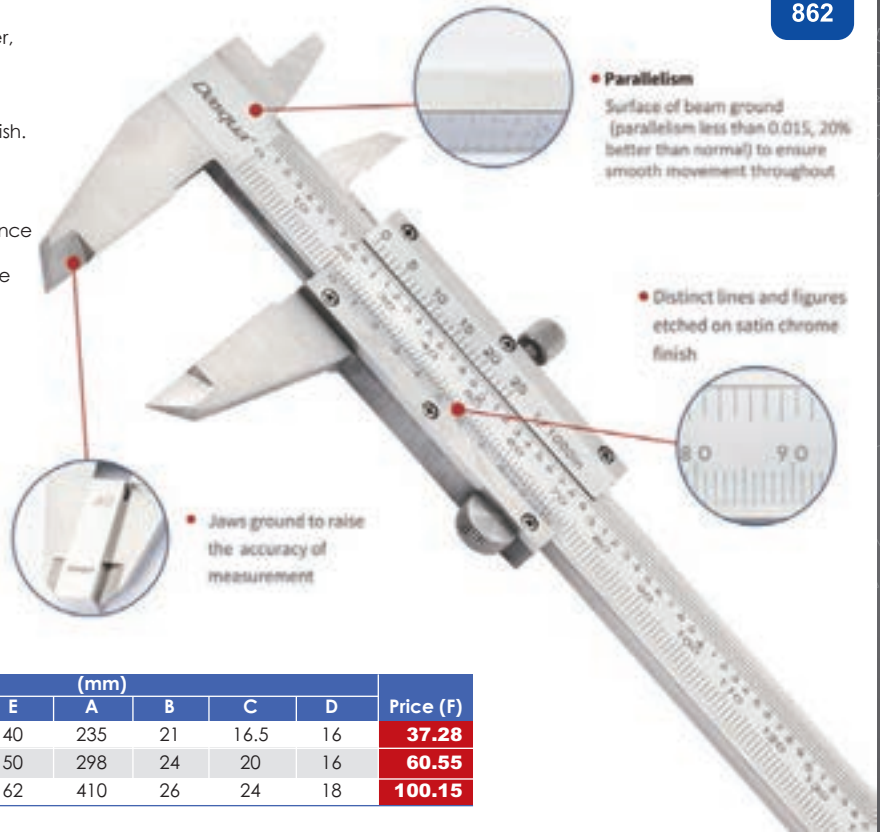
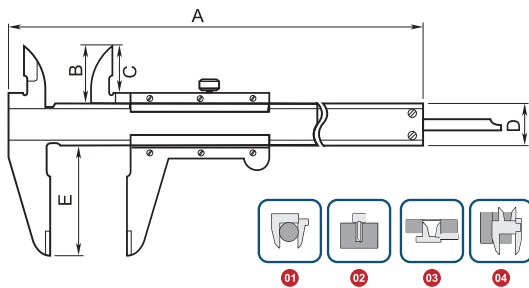

Item#	Range	Reading	(mm)					Price (F)
			E	A	B	C	D	
1550-2005	0-6"/0-150mm	0.02mm/0.001"	40	235	21	16.5	16	37.28
1550-2010	0-8"/0-200mm	0.02mm/0.001"	50	298	24	20	16	60.55
1550-2015	0-12"/0-300mm	0.02mm/0.001"	62	410	26	24	18	100.15

Dasqua® VERNIER CALIPERS-WITH FINE ADJUSTMENT

DIN 862

- 4 usages for measuring outside, inside, step and depth.
- Made of solid stainless steel.
- Strictly made in accordance with DIN862.
- Distinct lines and figures etched against satin chrome finish.

- With locking screw for stable reading.
- With fine adjustment.

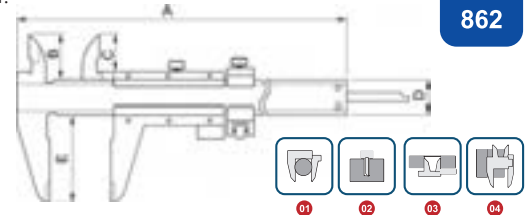

Item#	Range	Graduation	(mm)					Accuracy	Price (F)
			A	B	C	D	E		
1490-7005	0-6"/0-150mm	0.001"/0.02mm	235	21	16.5	16	40	0.03mm	40.46
1490-7010	0-8"/0-200mm	0.001"/0.02mm	298	24	19.5	16	50	0.03mm	64.35
1490-7015	0-12"/0-300mm	0.001"/0.02mm	410	26	20.0	18	55	0.03mm	104.21

PRECISION HEAVY DUTY LONG RANGE VERNIER CALIPERS

- With fine adjustment thumb screw
- Hardened stainless steel throughout.
- All measuring surfaces are ground and lapped for extreme accuracy.
- Supplied in wooden case.
- Satin chrome finish: Non-glare.
- Meets DIN 862

Reading .001"/ .02mm

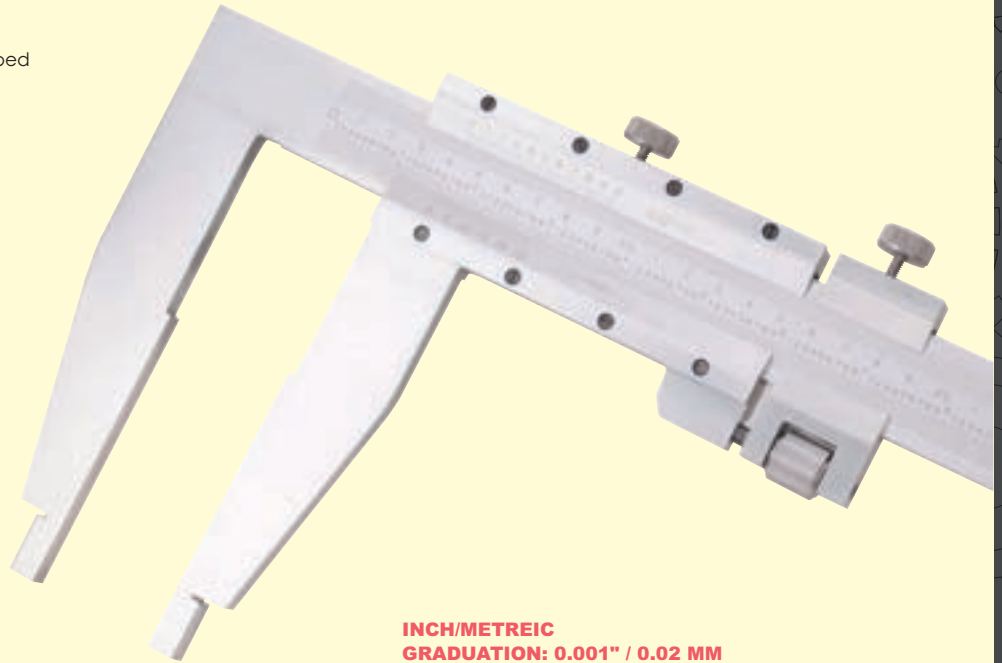

INCH/METREIC
GRADUATION: 0.001" / 0.02 MM

Item#	Range	Jaw Depth	Radiused Jaw Width	Price (F)
4100-0006	0-24" / 0-600mm	4"	10mm	117.83
4100-0008	0-40" / 0-1000mm	5-1/2"	20mm	321.05
4100-0009	0-60" / 0-1500mm	6-1/2"	20mm	876.55
4100-0010 ⁺	0-80" / 0-2000mm	7-1/2"	30mm	1,003.75

+ Truck Ship Only

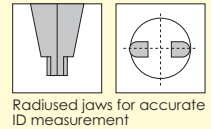

Dasqua® LONG JAW VERNIER CALIPERS

- Hardened ground jaws with precision lapped measuring faces.
- Satin chrome finish, hardened stainless steel throughout for longer life.
- Black lines and figures against the satin chrome finish provide easy and error-free reading.
- Inch/Metric graduation.

- Two-way measurement: ID and OD.
- Jaws have rounded measuring faces for accurate inner diameter (ID) readings.
- Fine adjustment for precision measurement.
- Long jaws for hard to reach areas.
- Fitted plastic case.

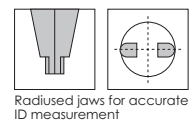
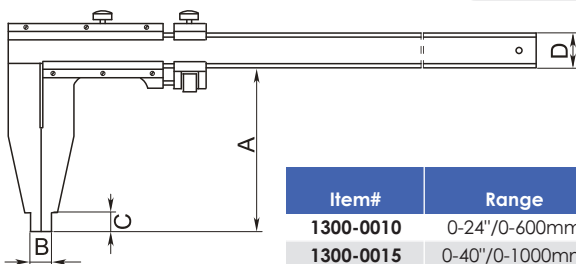
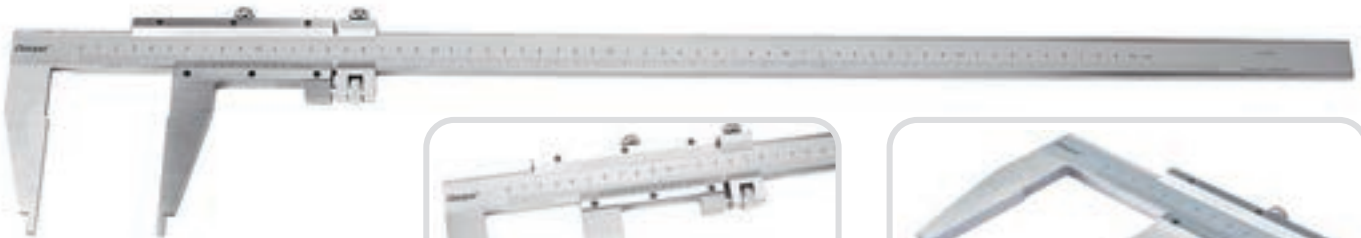

Item#	Range	Reading	(mm)				Accuracy	Price (F)
			A	B	C	L		
1300-0010	0-24"/0-600mm	0.001"/0.02mm	100	10	12	25	±0.05mm/0.002"	140.74
1300-0015	0-40"/0-1000mm	0.001"/0.02mm	125	20	18	32	±0.07mm/0.0028"	346.27

INSPECTION SETS

Pro-Series 3PC INSPECTION TOOL KIT

0~6" Dial Caliper:

- 0.001" graduation in one revolution,
- Hardened stainless steel, screw-on rack, shock-proof,
- 4-way measurements (inside, outside, depth and step),
- Dial face 1-1/2" diameter with special designed knurled bezel,
- Decimal and fraction conversion chart on back of caliper

0~0.03" Dial Test Indicator:

- 0-15-0 reading, 0.0005" graduation,
- Complete with 2 stems (5/32" & 3/8"),
- Precision pivot bearing,
- 0.098" contact point,
- Dovetail mounts (top, back & front),
- Jeweled movements,
- Auto reversing.

Limited Supply!

4902-0003
\$106⁴⁰

Complete with fitted case

0~1" Outside Micrometer:

- 0.0001" graduation,
- Anvil and spindle hardened and precision ground, carbide tipped measuring faces, ratchet stop,
- Adjustment wrench supplied



4PC STUDENT'S KIT



0~1" Outside Micrometer:

- 0.0001" graduation
- Carbide tipped
- Ratchet stop

4902-0004
\$98⁸²

Complete with fitted case

4" Bevel Squarer:

- Beam size 2-3/4"
- Ground and lapped accuracy for straightness, parallelism, and at right angles.

0~6" Dial Caliper:

- 0.001" graduation
- 4-way measurement
- Stainless steel
- Shock-proof

6" Flex Ruler:

- 4R graduation
- Satin chrome finish
- Stainless steel

6PC CALIPER, MICROMETER & SQUARE KIT



0~6" Dial Caliper:

- 0.001" graduation
- 4-way measurement
- Stainless steel
- Shock-proof

Combination Square:

- 12" 4R blade
- Square head
- Protractor head
- Center head

4902-0009
\$169³⁴

Complete with fitted case

0-1" Outside Micrometer:

- 0.0001" graduation
- Carbide tipped
- Ratchet stop

Z-Limit 2PC VERNIER CALIPER & MIC KIT

- Manufactured and inspected at world class factory that produces highest quality US brands.

- 0~1" Outside Micrometer, Resolution: .0001"
- 0~6" Vernier Caliper, Resolution: .001"/ 1/128"

4909-0002
\$101⁴⁴

Complete with fitted case

Limited Supply!



6PC INSPECTION TOOL KIT

22pc Indicator Point Set:

- AGD specification (4-48 threads)
- Fits most indicators

0-0.03" Dial Test Indicator:

- 0.0005" graduation,
- Complete with 2 stems (5/32" & 3/8")

0-1" Outside Micrometer:

- 0.0001" graduation
- Carbide tipped
- Ratchet stop

0~6" Dial Caliper:

- 0.001" graduation
- 4-way measurement
- Stainless steel
- Shock-proof

0-1" Dial Indicator:

- 0.001" graduation
- 2" dial face

Magnetic Base:

- Fine adjustment
- 130 lbs. power pull.

4902-0006
\$176⁹⁰

Complete with fitted case



Dasqua® 7PC ULTRA PRECISION MACHINIST KIT

IP67
COOLANT & FLUID
RESISTANT

SET INCLUDES:

- 176lbs. super strong power pull 275mm arm length magnetic base with fine adjustment (7121-0025)
- Big screen IP67 oil proof digital caliper, 0-150mm/0-6" range, 0.0005" resolution, inch/metric/fraction (2015-2405)
- 0-150mm/0-6" rule, graduations: 0.5, 1.0, 1/64", 1/32", 1/16" (1012-2011)
- IP65 digital outside micrometer, 0-25mm/0-1" range, 0.0005" resolution (4410-1105)
- Dial test indicator with shock proof gearing, 0-0.8mm range, 0.001" resolution (5211-1129)
- Ultra precision 1-2-3 blocks, squareness 0.0001"/1" (8407-0005)
- Depth base attachment (3001-1001)

7PC Set
2210-8250
\$44280
(F)
Complete with fitted case

**A MUST FOR
EVERY MACHINIST!**



Z-Limit 2PC ELECTRONIC CALIPER & MIC KIT

- Manufactured and inspected at world class factory that produces highest quality US brands.
- 0-1" IP54 Digital Micrometer, Resolution: .00005"
- 0-6" Digital Caliper with Precision Glass Scale, Resolution: .0005"
- Absolute Measuring System
- Standard CR-2032, 3V battery included.

Z-Limit
ULTRA-SERIES

4909-0012
\$21406
(F)
Complete with fitted case

IP 54

Limited Supply!

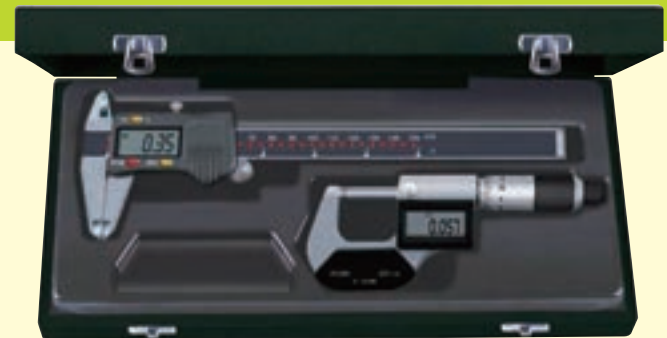

REPLACEMENT BATTERY (ITEM #4102-0032)....\$3.32

Dasqua® 2PC IP54 ABSOLUTE ELECTRONIC MEASURING SET



IP54
COOLANT & FLUID
RESISTANT

**DIN
862**

**DIN
863**

**mm
in**

**Battery
+
CR2032**

- Strictly made in accordance with **DIN 862/863**.
- Caliper and micrometer water resistance reach to IP54 standard.
- 0-6"/0-150mm (0.0005"/0.01mm) digital caliper with **Absolute function**.
- 0-1"/0-25mm (0.00005"/0.001mm) digital micrometer.
- Metric/Inch conversion.
- Standard CR-2032, 3V battery included.

RESOLUTION
CALIPER- 0.0005"/0.01mm
MICROMETER- 0.00005"/0.001mm

2PC SET
4209-1002
\$16029
(F)
Complete with fitted case

Limited Supply!



REPLACEMENT BATTERY (ITEM #4102-0032)....\$3.32

MICROMETER ACCESSORIES

10PC MEASURING TOOL SETTING MASTERS

- Quick easy and extremely accurate.
- Each block comes with a certificate of calibration.
- Complete with aluminum carry case.
- **Set Includes:**
9pc Gage Blocks(Grade 0): .0625", .100", .125", .200", .250", .300", .500", 1.000", & 2.000"
1 PC Optical Flat: 1" Dia. x .5125" Thickness, .000004" Flatness, .00002" Parallel

4101-0036
\$35745
(E)



THREAD TRIANGLE

- One pair gauges all 60° threads from 4-80 pitch, standard and special
- For any thread, mic the distance over the triangles, then refer to the chart to determine class of fit
- For special threads, add constant to nominal O.D. and check against mic reading to determine class of fit



Standard 60°
4901-0063
\$4081
(E)
PER PAIR



For Checking All
Standard 60° Threads



12PC MICRO CHECKING SET



Grade AS-0= Grade 2(AI) : +4/-2 milliont

- For checking various spindle positions of entire micrometer range.
- Meet or exceeds U.S. Federal specification GGG-G-15C and ISO 9000 requirements.
- Gauge blocks include: .105, .210, .315, .420, .500, .605, .710, .815, .920 & 1.000".
- Optical flats for checking micrometer flatness are .500 & .5125"
- Manufacturer's calibration certificate included.
- Completed with fitted case.

Grade AS-0
4101-0032
\$31910
(F)

INCH & METRIC THREAD WIRE SET

- Measures all metric threads from .5mm to 6mm.
- 48 wires; 16 different sizes.
- Measures all 60° thread from 3 to 48 threads per inch.
- Laminated chart included.
- Complete in vinyl case.

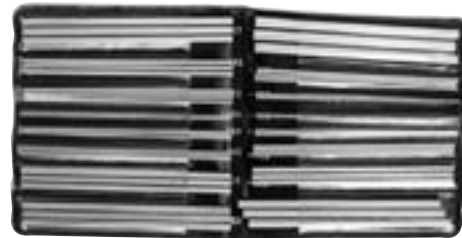

4200-0241
\$1393
(F)

10PC MICRO CHECKING SET



Grade AS-0= Grade 2(AI) : +4/-2 milliont

- Meet or exceeds U.S. Federal specification GGG-G-15C and ISO 9000 requirements.
- Gauge blocks include: .0625, .100, .125, .200, .250, .300, .500, 1.000 & 2.000".
- Optical flats for checking micrometer flatness.
- Manufacturer's calibration certificate included.
- Completed with fitted case.

Grade AS-0
4101-0031
\$26270
(F)

Pro-Series INCH & METRIC THREAD WIRE SET

- Measures all 60° threads
- 48 pieces -16 different sizes
- Measures all threads from 3 to 48 threads per inch and all metric from 0.5mm to 6mm pitch.
- 3 wire methods of measuring external threads.
- Wires are fitted in a plastic case stamped with sizes.
- Chart compiled from the U.S. Standard Handbook H.28, and gives proper sizes & measurements over wires.
- Comes with 4 wire holders, each holder has 2 pair of holes, each pair of holes for different size of wire and make pitch diameter measuring much easier.



4200-0240
\$2646
(F)

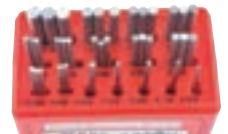

MICROMETER STAND

- Fully adjustable micrometer clamp.
- Non marring.
- Lacquered cast iron base.
- Clamping capacity: 5/8".
- Flat frame style.
- Base weight: 3 lbs.

Limited Supply!

4401-0043
\$1997
(F)



7PC ANVIL ATTACHMENT KIT FOR OUTSIDE MICROMETERS

- Turns your micrometer into 7 different tools.
- Set contains: ball, spline, knife, super spline, blade, comparator.
- Fits all brands of outside micrometers.
- Attachments other than ball are .500" long. This mount must be subtracted from the total reading.
- Hardened and ground.



4200-0131
\$7792
(F)

4200-0130
\$1889
(F)

Dasqua® MICROMETER STAND

- Keep hands free for operating micrometer and positioning workpiece.
- Perfect for batch or mass production measurements in manufacturing and quality assurance.
- Blue enamel finish.
- Very sturdy and stable.
- Case iron.

up to 100mm/4"
7111-1105
\$2193
(F)



BALL ATTACHMENT

- Used for measuring parts with rounded surfaces
- Ball attachment is applied by snapping onto end of either anvil or spindle.
- Anvil Diameter: .250"
- Includes: 1Ball, 1Sleeve



4200-0135
\$434
(F)

PORTABLE MICROMETER STAND

- Micrometer stand is uniquely designed for easy locking and carrying around.
- Stand can be folded to dimension: 4.6" x 3.2" x 1.5"
- Lacquered cast iron stand weighing 2 lbs.

4401-0044
\$2511
(F)



MICROMETER SOLD SEPARATELY

METAL CASES - FOR OUTSIDE MICROMETER SETS

- Well made aluminium case.
- Durable foam inserts for better protection.
- Fits most outside micrometer sets on the market.



MICROMETERS NOT INCLUDED

4200-0166 CASE
\$4610
(F)



4200-0163 CASE
\$11446
(F)

OUTSIDE MICROMETERS

Dasqua® OUTSIDE MICROMETERS



4112-5110 Shown



- Strictly made in accordance with DIN 863.
- With ratchet stop for constant pressure.
- Spindle thread hardened, ground and lapped for ultimate accuracy.
- Clear graduations laser-etched on satin chrome finish for easy reading.
- With spindle lock.
- Carbide measuring surfaces ground for longer service life.
- Standards included above 0-1" micrometer.
- Fitted case.

.001" GRADUATION

Item#	Inch	(mm)						Accuracy	Price (F)
		A	B	C	L	W	H		
4112-5105	0-1"	31	29.5	Ø6.5	133	58.5	18	0.0015"	34.37
4112-5110	1-2"	56	38	Ø6.5	137.2	76	18	0.0015"	41.00
4112-5115	2-3"	81	51	Ø6.5	162.7	91	18	0.002"	46.36
4112-5120	3-4"	106	63.5	Ø6.5	210.5	105	18	0.002"	56.06



Included

.0001" GRADUATION

Item#	Inch	(mm)						Accuracy	Price (F)
		A	B	C	L	W	H		
4112-0105	0-1"	31	29.5	Ø6.5	133	58.5	18	0.00015"	34.14
4112-0110	1-2"	56	38	Ø6.5	137.2	76	18	0.00015"	41.00
4112-0115	2-3"	81	51	Ø6.5	162.7	91	18	0.0002"	46.36
4112-0120	3-4"	106	63.5	Ø6.5	187.7	105	18	0.0002"	60.16
4112-0125	4-5"	131	76	Ø6.5	214.5	125	18	0.00025"	68.67
4112-0130	5-6"	156	89	Ø6.5	251	142	18	0.00025"	75.95

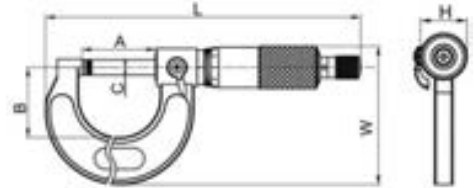

Dasqua® LARGE OUTSIDE MICROMETERS

DIN 862

- Strictly made in accordance with DIN 863.
- With ratchet stop for constant pressure.
- Spindle thread hardened, ground and lapped for ultimate accuracy.
- Clear graduations laser-etched on satin chrome finish for easy reading.
- With spindle lock.
- Bigger size for larger range.
- Carbide measuring surfaces ground for longer service life.
- Zero setting standard bar
- Tapered designed frame for easier use in narrow slots and tight locations.
- Rigid steel frame is ribbed for extra strength.
- Fitted case.



4112-1150 Shown

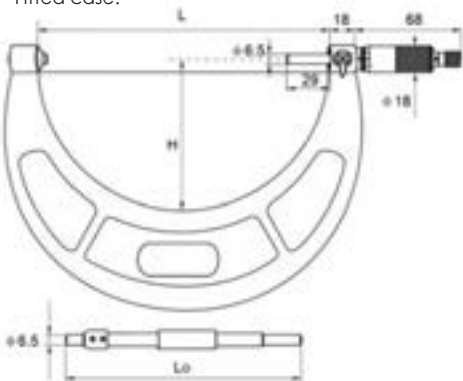

.0001" GRADUATION

Item#	Range	(mm)			Accuracy	Price (F)
		L	H	Lo		
4112-1135	6-7"	185	99	150	0.00027"	77.32
4112-1140	7-8"	210	111.5	175	0.00027"	84.03
4112-1145	8-9"	238	127	200	0.0003"	89.44
4112-1150	9-10"	264	140	225	0.0003"	98.44
4112-1155	10-11"	289	152.5	250	0.00035"	104.21
4112-1160	11-12"	315	165.5	275	0.00035"	109.82

Dasqua® OUTSIDE MICROMETER SETS

DIN
863

- Strictly made in accordance with **DIN 863**.
- With ratchet stop for constant pressure.
- Spindle thread hardened, ground and lapped for ultimate accuracy.
- Clear graduations laser-etched on satin chrome finish for easy reading.
- With spindle lock.
- Standards are included above 0-1" micrometer.

Plastic Case

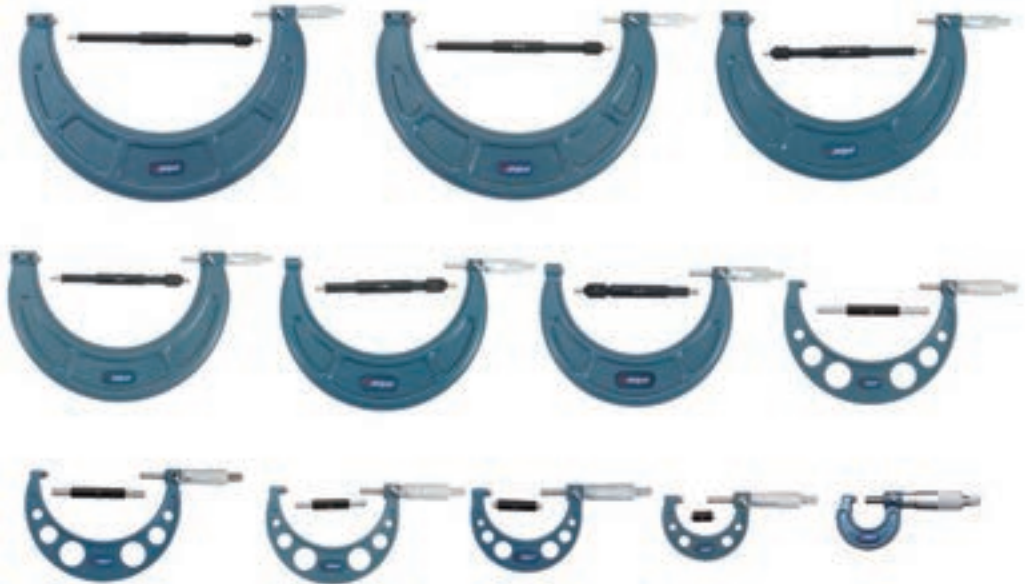

Aluminium case



.001" GRADUATION

Item#	Set/pcs	Range	Package	Price (F)
4112-0206	3	0-3"	Plastic Case	120.74

.0001" GRADUATION

Item#	Set/pcs	Range	Package	Price (F)
4112-0006	3	0-3"	Plastic Case	120.74
4112-0010	4	0-4"	Plastic Case	175.37
4112-0215	6	0-6"	Aluminium Case	324.95
4112-0203	12	0-12"	Aluminium Case	921.49

SOLID METAL FRAME OUTSIDE MICROMETERS & SETS

- Solid Mitutoyo style metal C-shape frame for all sizes.
- Graduation: 0.0001"
- Hardened and precision ground anvil spindle thread with microlap finish on ends.
- Positive locking clamp with ratchet stop.
- Carbide tipped faces.
- Meets or exceeds federal specifications.
- Supplied with fitted case.



.0001" GRADUATION

0~12" Set
Consists of 0~6 & 6~12" SET
4200-0163
\$ **816⁹⁵**
(F)

Item#	Range	Price(F)
4200-0150	0-1"	32.40
4200-0152	1-2"	36.90
4200-0153	2-3"	44.00
4200-0154	3-4"	57.15
4200-0155	4-5"	65.20
4200-0156	5-6"	72.15
4200-0157	6-7"	78.15
4200-0158	7-8"	87.79
4200-0159	8-9"	101.44
4200-0160	9-10"	106.24
4200-0161	10-11"	122.50
4200-0162	11-12"	137.14



STANDARDS INCLUDED

0~3" Set
4200-0165
\$ **113⁰⁰**
(F)

0~6" Set
4200-0166
\$ **297³⁶**
(F)

0~4" Set
4200-0164
\$ **150⁶³**
(F)

6~12" Set
4200-0167
\$ **598⁹⁵**
(F)

Limited Supply!

OUTSIDE MICROMETERS

PRECISION OUTSIDE MICROMETERS & SETS

- Hardened and precision ground anvil spindle thread with microlap finish on ends.
- Meets or exceeds federal specifications.
- Micro fine graduations.
- Spindle lock.
- Graduation: 0.0001".
- Carbide faces.
- Ratchet stop.
- Fitted case.
- Standards included.

0~3" Set
4200-0010
\$118.27
(E)

.0001" GRADUATION

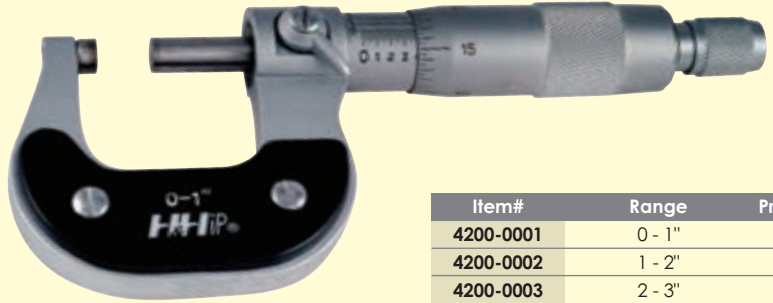

Item#	Range	Price (E)
4200-0001	0 - 1"	35.70
4200-0002	1 - 2"	37.20
4200-0003	2 - 3"	43.38
4200-0010	0 - 3" (3pc/set)	118.27
4200-0011	0 - 6" (6pc/set)	292.65

Dasqua® METRIC OUTSIDE MICROMETER

- Strictly made in accordance with **DIN 863**.
- With ratchet stop for constant pressure.
- Spindle thread hardened, ground and lapped for ultimate accuracy.

- Clear graduations laser-etched on satin chrome finish for easy reading.
- With spindle lock.
- Made with thermal protection frame.

DIN 863



Item#	Range	Graduation	Package	Price (F)
4111-6405	0-25mm	0.01mm	Plastic Box	31.20

Dasqua® METRIC OUTSIDE MICROMETERS & SET

DIN 863

- Strictly made in accordance with **DIN 863**.
- With ratchet stop for constant pressure.
- Spindle thread hardened, ground and lapped for ultimate accuracy.
- Clear graduations laser-etched on satin chrome finish for easy reading.
- With spindle lock.
- Carbide measuring surfaces ground for longer service life.
- Standards included above 0-1" micrometer.
- Fitted case.

3PC Set
0~75mm Range
4111-8206
\$132.55
(F)

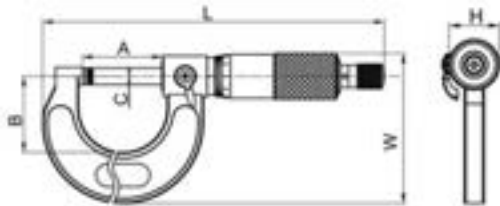
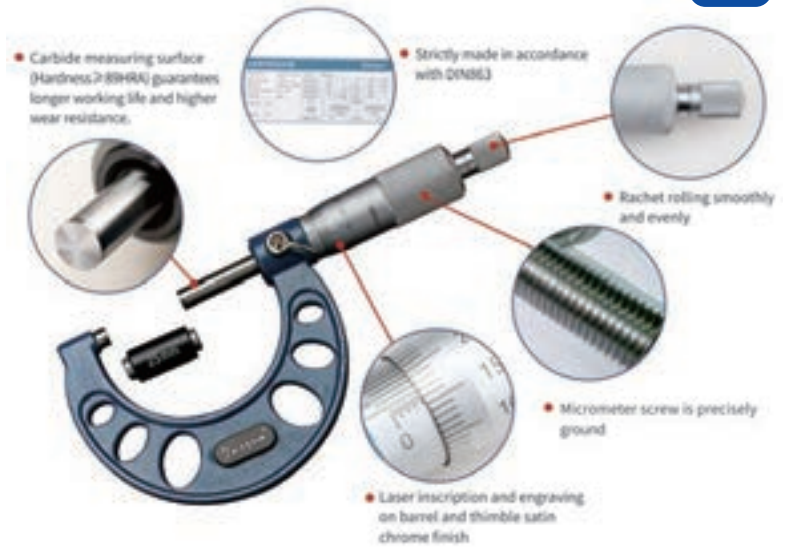

.01MM GRADUATION

Item#	Range	(mm)						Accuracy	Price (F)
		A	B	C	L	W	H		
4111-8105	0-25mm	31	29.5	Ø6.5	133	58.5	18	0.004"	36.95
4111-8110	25-50mm	56	38	Ø6.5	137.2	76	18	0.004"	46.77
4111-8115	51-75mm	81	51	Ø6.5	162.7	91	18	0.004"	50.73



Included

DIGITAL READOUT OUTSIDE MICROMETER

- Anvil and spindle hardened and precision ground with microlap finish.
- Carbide tipped measuring faces.
- Ratchet stop.
- Meets or exceeds U.S. Federal specifications.
- Supplied with fitted case.



.0001" GRADUATION

0~1" Range
4200-0020
\$9082
(F)

DEEP THROAT MICROMETER

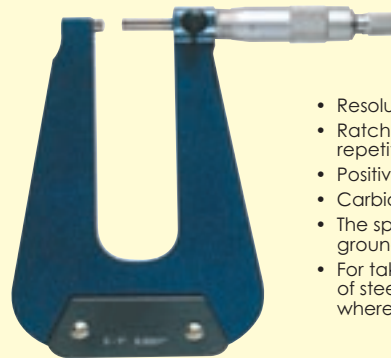

.0001" GRADUATION

- Resolution: 0.0001".
- Ratchet stop thimble for exact and repetitive readings.
- Positive locking clamp.
- Carbide tipped measuring faces.
- The spindle thread is hardened, ground and lapped.
- For taking accurate measurements of steel and plastic sheets and plates wherever there is a deep depth.

Item#	Range	Throat Depth	Accuracy	Price (E)
4200-0208	0-1"	6"	.0001"	167.70

INTERCHANGEABLE ANVIL MICROMETERS

- Long range outside micrometers.
- Pipe combined steel frame provides lightness plus extreme rigidity for perfect balance.
- Micro fine graduations.
- Carbide tipped measuring faces.
- Ratchet stop.
- Fitted case.
- Standards included.



.001" GRADUATION

12~16" Range
4200-0171
\$48125
(F)

Item#	Range	Accuracy	Price (E)
4200-0171	12-16"	.001"	481.25
4200-0172	16-20"	.001"	573.43
4200-0173	20-24"	.001"	632.92
4200-0174	24-28"	.001"	786.38
4200-0175	28-32"	.001"	967.87

Dasqua® MICROMETER HEADS

- Used for improving accuracy in machines, gaging, test equipment, electronics, optical instruments and machine instruments.
- Satin chrome finished-no glare and resists rust.
- Quick reading on thimble.
- Flat face spindle with high precision.
- Ratchet thimble and threads are hardened ground and lapped for consistent repeatability and accuracy.
- Quick and easy adjustment.
- Carbide measuring surfaces ground for longer service life.

0~1" Range
4812-5115
\$2844
(E)

.001" GRADUATION

Item#	Range	Accuracy	Price (E)
4812-5105	0-0.25"	0.0015"	25.04
4812-5110	0-0.5"	0.0015"	25.74
4812-5115	0-1"	0.0015"	28.44
4812-5120	0-2"	0.0015"	72.64

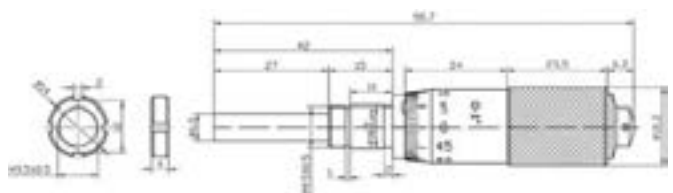

SPECIALTY MICROMETERS

Dasqua® BALL SPHERICAL FACE MICROMETERS

DIN 863

- For measuring wall thickness of various curved parts & tubes, including bearings, sleeves, collars, rings, cylinders and from a hole to an edge.
- Strictly made in accordance with DIN 863.
- Accuracy: 0.0001"/0.004mm.
- Spindle thread hardened, ground and lapped for ultimate accuracy.
- Barrel and thimble satin chrome finish.
- Carbide measuring face.
- Clear graduations on satin chrome finish for easy reading.
- Quick and easy zero adjustment on sleeve.
- Positive lever locking clamp and ratchet stop.
- Ideal for measuring convex curves directly without having to subtract the diameter of the ball.
- Supplied with fitted case.



4510-2305 Shown



4510-2310 Shown

.0001" GRADUATION

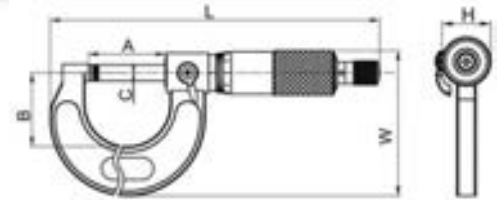

Item#	Range	(mm)						Accuracy	Price (F)
		A	B	C	L	W	H		
4510-2305	0-1"	31	29.5	Ø6.5	133	58.5	18	0.00015"	47.29
4510-2310	1-2"	56	38	Ø6.5	137.2	76	18	0.00015"	53.48

PRECISION MEASURING TOOLS

SCREW THREAD MICROMETER KITS

- Direct reading of pitch diameter in threads with interchangeable anvil and spindle pairs.
- Anvils and spindles made of tool steel, hardened and ground.
- Micro fine slant line graduations.
- Ratchet stop.
- With fitted case.



.001" GRADUATION



Anvil in Pairs	Pitch TPI
#1	64~48
#2	44~28
#3	24~14
#4	13~9
#5	8~5
#6	4.5~3.5
#7	28~20
#8	18~12
#9	11~7
#10	6~4.5

Item#	Range	Anvils	Price (E)
4200-0226	0-1"	#1-5	131.10
4200-0227	1-2"	#2-6	135.00
4200-0228	2-3"	#7-10	162.11

ELECTRONIC SCREW THREAD MICROMETER KIT

- Non-rotation spindle
- 60° V-shaped and knife-edged anvils
- With cable for RS232 output.
- Ratchet stop.
- With fitted case.
- Direct RS232 output.



INCH/METRIC .00005" GRADUATION

Anvil in Pairs	Pitch	
	TPI	MM
#1	64~48	.4~.5
#2	44~28	.6~.9
#3	24~14	1.0~1.75
#4	13~9	2~3
#5	8~5	3.5~5.0

REPLACEMENT BATTERY (ITEM #4102-0030)....\$3.19

Item#	Range	Anvils	Price (E)
4200-0361	0-1"	#1-5	296.03

Dasqua® VERNIER SPLINE MICROMETERS

DIN
863

- For measuring spline shafts, slots and keyways.
- Strictly made in accordance with DIN863.
- Graduation: 0.0001".
- Spindle thread hardened, ground and lapped for ultimate accuracy.
- Barrel and thimble have satin chrome finish.
- Carbide measuring face.
- Clear graduations on satin chrome finish for easy reading.

- Quick and easy zero adjustment on sleeve.
- Positive lever locking clamp and ratchet stop for exact readings.
- The anvil & shaft have a small diameter for measuring splined shafts, slots, and keyways.
- Supplied with standards bar except 0-1" model.
- Non-rotating spindle.
- Supplied with fitted case.



.0001" GRADUATION

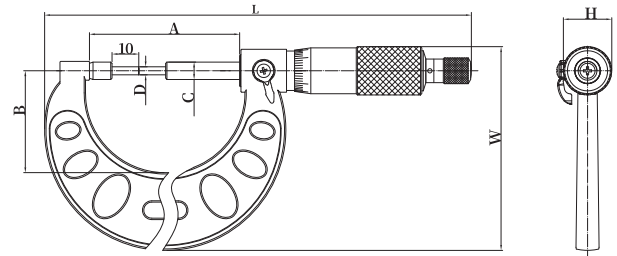

Item#	Range	Resolution	(mm)						Accuracy	Price (F)
			A	B	C	L	W	H		
4710-2305	0-1"	0.0001"	56	38	Ø6.5	137.2	76	18	0.004mm/0.00015"	74.07
4710-2310	1-2"	0.0001"	55.3	31	Ø6.5	162.7	91	18	0.004mm/0.00015"	70.98
4710-2315	2-3"	0.0001"	80.8	44	Ø6.5	187.7	105	18	0.004mm/0.0002"	87.85

Dasqua® POINTED SPINDLE & ANVIL MICROMETERS

DIN
863



- For measuring the web thickness of drills, small grooves, and other hard to reach dimensions.
- Strictly made in accordance with DIN 863.
- Spindle thread hardened, ground and lapped for ultimate accuracy.
- Barrel and thimble have satin chrome finish.
- Carbide measuring face.
- Clear graduations on satin chrome finish for easy reading.
- Quick and easy zero adjustment on sleeve.
- Positive lever locking clamp and ratchet stop.
- Size 1-2" and 2-3" furnished with standards for micrometer reading verification.
- Supplied with fitted case.

.0001" GRADUATION

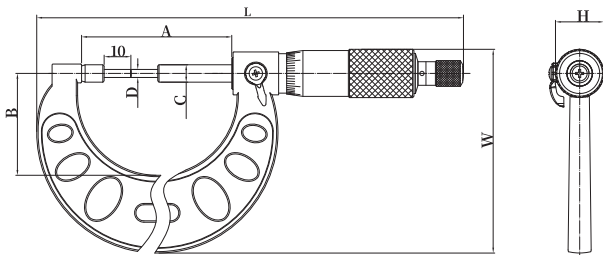

Item#	Range	(mm)						Accuracy	Price (F)
		A	B	C	L	W	H		
4610-2305	0-1"	56	38	Ø6.5	137.2	76	18	0.00015"	61.49
4610-2310	1-2"	81	51	Ø6.5	162.7	91	18	0.00015"	68.09
4610-2315	2-3"	106	63.5	Ø6.5	187.7	105	18	0.0002"	87.80

SPECIALTY MICROMETERS

INDICATING MICROMETERS

- Carbide tipped measuring faces.
- Jeweled bearings.
- Retracting button.
- Tolerance hands.
- Easy zero adjustment.
- With fitted case.
- Standard included.



.00005" GRADUATION



* Limited Supply

0~1" Range
4200-0205
\$325⁵³
(E)

1~2" Range
4200-0206*
\$297¹⁸
(E)

PRECISION BLADE MICROMETER

- Graduation: .0001".
- For taking measurements of workpieces which have narrow grooves or "T" slots when standard micrometer can't reach.
- Microfine graduations on satin chrome finish for easy reading.
- Anvil & spindle hardened & precision ground.

- Blade penetration=0.315".
- Blade thickness=0.03".
- Blade width=0.256".
- Non-rotating spindle.



.0001" GRADUATION
.0016" ACCURACY

Limited Supply!



0~1" Range
4200-0251
\$138⁰⁴
(E)

PRECISION MEASURING TOOLS

Dasqua® DIGITAL ELECTRONIC IP65 WATER PROOF BLADE MICROMETERS

- Absolute function.
- For measuring narrow grooves and hard-to-reach areas.
- Quick measuring function. Lever activated opens & closes on fixed thimble in under one second.
- Large, easy-to-read digital display.
- Class A in electrostatic discharge.
- Carbide-tipped anvils.
- Measuring spindle hardened and ground.
- IP65 protection against coolants, dirt, chips and grit.
- Standard included above 0-1".
- Accuracy: 0.00015"
- True Inch/Metric conversion.
- Non-rotating spindle.
- Furnished in fitted case.

CABLE 01	DIN 863	IP65 COOLANT FLUID RESISTANT	BLUETOOTH TRANSMITTER	WIRELESS TRANSMITTER
Data output	Absolute	Battery + CR2032	mm	inch



Incredibly Accurate & Easy to Use

INCH/METRIC .0005" GRADUATION



Quick-Move

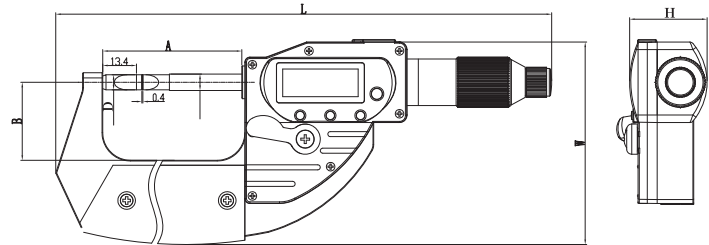

Item#	Range	Resolution	(mm)						Accuracy	Price (F)
			A	B	C	L	W	H		
4220-2103	0-1"/0-25mm	0.00005"/0.001mm	29.8	25.4	Ø6.5	168.6	64.6	30.8	0.00015"/0.003mm	299.44
4220-2106	1-2"/25-50mm	0.00005"/0.001mm	55.3	31	Ø6.5	197.2	80.5	30.8	0.00015"/0.003mm	330.46
4220-2109	2-3"/50-75mm	0.00005"/0.001mm	80.3	44	Ø6.5	227.5	96	30.8	0.00015"/0.004mm	366.50

Dasqua® IP65 SPLASH PROOF DIGITAL ELECTRONIC OUTSIDE MICROMETERS



Strictly made in accordance with DIN863 and with calibration certificate

Clear easy to read graduation lines
Laser inscription and engraving

Carbide measuring surface (Hardness $\geq 89\text{HRA}$) guarantees longer working life and higher wear resistance.

Precision ratchet thimble cap maintains uniform measuring pressure to reduce errors

IP65 protection, ensuring precision performance in harsh environments

- A-class static protection.
- Display absolute position at startup.
- Insulating grips are employed on the frame to reduce heat transfer.

**INCH/METRIC
.0005" GRADUATION**



0-1"/0-25mm
4410-1105
\$125.55 (F)

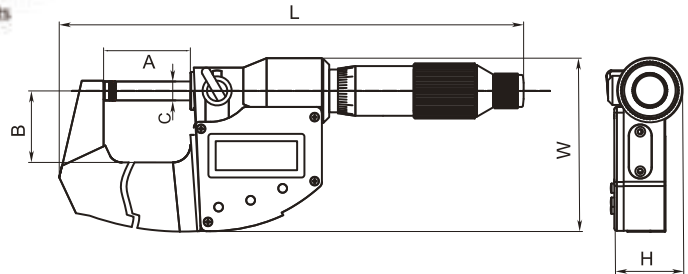

Item#	Range	Resolution	(mm)						Accuracy	Price (F)
			A	B	C	L	W	H		
4410-1105	0-1"/0-25mm	0.00005"/0.001mm	29.8	24.5	Ø6.5	159.5	59.6	23.5	0.00015"/0.003mm	125.55
4410-1110	1-2"/25-50mm	0.00005"/0.001mm	55.3	31	Ø6.5	188.5	75.7	23.5	0.00015"/0.003mm	154.60
4410-1115	2-3"/50-75mm	0.00005"/0.001mm	80.8	44	Ø6.5	219	90.7	23.5	0.00015"/0.004mm	172.67
4410-1120	3-4"/75-100mm	0.00005"/0.001mm	105.8	56	Ø6.5	246.5	107.2	23.5	0.00015"/0.004mm	194.22
4410-1125	4-5"/100-125mm	0.00005"/0.001mm	130.8	68	Ø6.5	278	125.3	23.5	0.0002"/0.005mm	228.57
4410-1130	5-6"/125-150mm	0.00005"/0.001mm	155.8	81	Ø6.5	307.5	141.3	23.5	0.0002"/0.005mm	268.61

Dasqua® MICROMETER STAND

- Keep hands free for operating micrometer and positioning workpiece.
- Perfect for batch or mass production measurements in manufacturing and quality assurance.
- Blue enamel finish.
- Very sturdy and stable.
- Case iron.

up to 100mm/4"
7111-1105
\$219.3 (F)

Perfect for Batch or Mass Production



SPECIALTY MICROMETERS

Dasqua® 0-22" DIAL DEPTH GAGE KIT

- Used to measure depth of holes or parts with grooved or elevated surfaces.
- Dial Indicator for easy and clear reading.
- Hardened base with fine lapped contact surface.
- Extension rods of different lengths offering larger measuring ranges.

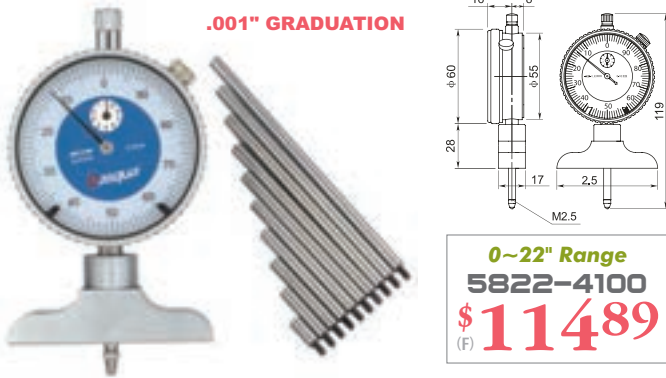

0~22" Range
5822-4100
\$114.89 (F)

0~22" DIAL DEPTH GAGE KIT



- Provides rapid, direct reading measurements of depths.
- 6 rod extensions can be connected together for a full 0-22" capacity.
- Supplied with fitted case.
- 2" diameter dial face.
- 2-1/2" base

0~22" Range
4500-0004
\$112.14 (F)

PRECISION DEPTH MICROMETER SETS

- Interchangeable rods are fitted to the micrometer spindle against a positive stop and locked.
- Base surface hardened & lapped.
- Ratchet stop for consistent and repetitive measurements.
- Satin chrome non-glare.
- Complete with fitted case and spanner wrench.

Item#	Range	Base size	No. of Rods	Accuracy	Price (F)
4500-0001*	0-4"	2.5"	4	0.001"	78.25
4500-0011	0-4"	4"	4	0.001"	91.34
4500-0002	0-6"	4"	6	0.001"	114.82

* Limited Supply

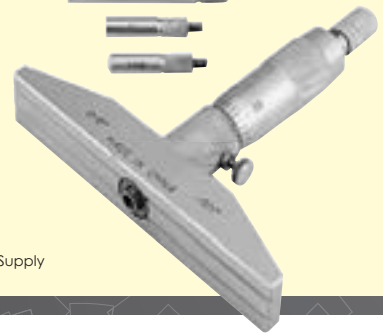

Dasqua® DEPTH MICROMETERS

- For measuring depth of holes, parts with grooves or elevated surfaces.
- Satin chrome finish.
- Ratchet thimble and threads are hardened, ground and lapped for consistent repeatability and accuracy.
- Positive locking clamp.
- Clear and easy-to-read graduations.
- With fitted case.

.0016" ACCURACY

Item#	Range	Graduation	No. of Anvils	(mm) Length	Price (F)
4612-5105	0-1"	0.001"	1	63	68.12
4612-5110	0-2"	0.001"	2	102	72.67
4612-5115	0-3"	0.001"	3	102	82.78
4612-5120	0-4"	0.001"	4	102	96.20
4612-5125	0-6"	0.001"	6	102	129.27



Dasqua® MONOBLOCK DEPTH VERNIER GAGES

DIN 862

- Hardened ground jaws with precision lapped measuring face.
- Satin chrome finish, hardened stainless steel throughout for long life.
- Distinct lines and figures etched against satin chrome finish.
- Strictly made in accordance with DIN 862.

.0001" GRADUATION

Item#	Range	(mm)		Accuracy	Price (F)
		L	D		
3001-2901	0-6"	250	100	±0.03	45.40
3001-2903	0-8"	300	100	±0.03	55.98
3001-2905	0-12"	400	100	±0.04	73.81

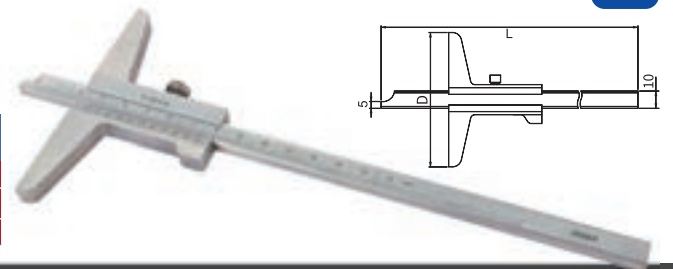

DIGITAL ELECTRONIC DEPTH MICROMETER KIT

- High accuracy Interchangeable rods
- High contrast LCD display
- Spherical end for easy straight measurement
- 4" base
- Friction thimble
- Standard SR44(1.55V) battery included
- With fitted case



0~6"/0~150mm
4500-0406
\$169⁸⁷
(E)

INCH/METRIC .0005" GRADUATION

REPLACEMENT BATTERY (ITEM #4102-0030)....\$3.19

Dasqua® DIGITAL ELECTRONIC DEPTH CALIPERS



**INCH/METRIC
.0005" GRADUATION**

- Used to measure step and depth.
- Made of solid stainless steel, widened and thickened.
- Strictly made in accordance with DIN 862.
- Hardened, ground and lapped measuring surfaces for longer service life.
- Large, easy to read display.
- Standard CR-2032 (3V) battery included.
- Fitted case.

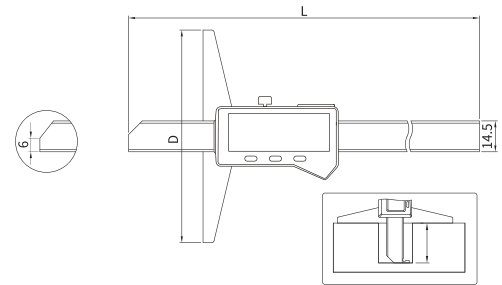

REPLACEMENT BATTERY (ITEM #4102-0032)....\$3.32

Item#	Range	Resolution	(mm)		Accuracy	Price (F)
			D	L		
9021-2005	0-6"/0-150mm	.0005"/.01mm	100	230	±0.03mm	70.12
2001-2010	0-8"/0-200mm	.0005"/.01mm	100	280	±0.03mm	87.07
2001-2015	0-12"/0-300mm	.0005"/.01mm	100	380	±0.04mm	108.26

Dasqua® DIGITAL ELECTRONIC THICKNESS GAGE

- Spring load movement with a push button.
- Large LCD display for easy and clear readings.
- Thickness measurement of different materials.
- Data hold function, data output.
- Standard CR-2032 (3V) battery included.
- Fitted case.



Data output

**INCH/METRIC/FRACTION
.0005" GRADUATION**

0~1"/0~25mm
2140-8110
\$49⁸²
(E)

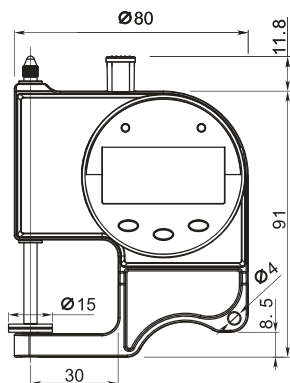

Cable 3 (ITEM #2220-9999).....\$81.95

Range	Resolution	Accuracy
0-25mm/0-1"	0.01mm / 0.0005" / 1/128"	0.05mm/0.002"

Dasqua® DIGITAL ELECTRONIC THICKNESS GAGE

- Large LCD display for easy and clear readings.
- Spring loaded travel.
- The compact size and lightweight ensure it is very convenient and handy, and easy to operate.
- Data hold function.
- Class A for electrostatic discharge.
- Standard CR-2032 (3V) battery included.
- Fitted case.



**INCH/METRIC/FRACTION
.0005" GRADUATION**

0~1"/0~25mm
2140-8105
\$51⁶⁹
(E)

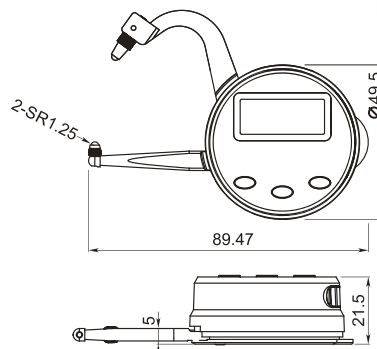

Range	Resolution	Accuracy
0-25mm/0-1"	0.01mm / 0.0005" / 1/64"	0.05mm/0.002"

SPECIALTY MICROMETERS

Dasqua® INSIDE MICROMETERS

- Used to measure various inside dimensions.
- With ratchet stop for constant pressure.
- Spindle thread hardened, ground and lapped for ultimate accuracy.
- Clear graduations laser-etched on satin chrome finish for easy reading.
- With spindle lock.
- Carbide measuring surfaces ground for longer service life.



.001" GRADUATION

Item#	Range	Graduation	Accuracy	Calibration ring	Type	(mm)				Price (F)
						A	B	C	D	
4912-5105	0.2-1.2"	0.001"	±0.00025"	Yes	A	2.3	4.5	5.5	27.5	99.24
4912-5110	1-2"	0.001"	±0.0003"	Yes	B	12.3	4.5	/	27.5	110.06
4912-5115	2-3"	0.001"	±0.00035"	No	B	12.3	4.5	/	27.5	112.45
4912-5120	3-4"	0.001"	±0.0004"	No	B	12.3	4.5	/	27.5	119.70

Dasqua® TUBULAR INSIDE MICROMETERS



- Wide range by combining extensions rods and anvils with micrometer head
- Clear graduation laser etched on satin chrome finish for easy reading.
- Strictly made in accordance with DIN863.
- Satin chrome finish.
- Supplied with a standard gauge for zero setting.
- Micrometer heads vary from 50mm to 63mm. Each micrometer head is with an extension rod depending on the customers' desired measuring range.
- Measuring rods hardened, ground and lapped.
- Fitted case.

.001" GRADUATION



Item#	Range	Graduation	Extension Rod	Accuracy	Price (F)
4312-5103	2-5.5"	0.001"	Micrometer Head	0.0002"	153.50
4312-5106	2-4"	0.001"	0.5", 1"	0.00025"	165.36
4312-5109	2-12"	0.001"	1/2", 1" 2", 2", 4"	0.00045"	239.30
4312-5112	2-20"	0.001"	0.5", 1" 2"(2pcs), 4", 8"	0.00065"	303.26

INSIDE MICROMETER SETS

- The combining of extension rods provides a wide measuring range
- Carbide measuring faces
- Positive lock clamp
- Supplied with a standard caliper gage for zero setting
- With Fitted Case



4200-0333 Shown

.001" GRADUATION

Item#	Range	Price (E)
4200-0332	4 - 20"	498.43
4200-0333	4 - 36"	638.81



4200-0332 Shown

Dasqua® IP54 WATER PROOF ELECTRONIC INTERNAL 3 POINT HOLE MIKE SETS

IP54
COOLANT & FLUID
RESISTANT

- Strictly made in accordance with DIN 863.
- Hold function.
- Direct reading from clear large easy-to-read Digital display.
- Self-centering micrometer hardened head; from 12mm with carbide measuring jaws for accurate & true measurement of internal diameters.
- Extension available for deep measuring.
- Setting rings included in all sets for adjustment.
- Ratchet stops providing correct contact pressure for accurate reading.
- Contact points are designed for measurements near the bottom of blind holes.
- Resolution: .00005"/.001mm
- Includes instant inch/millimeter conversion.
- Furnished in fitted case.



**INCH/METRIC
.0005" GRADUATION**

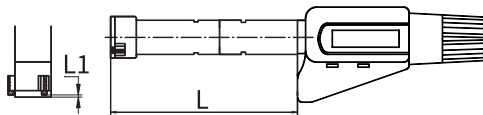

Item#	Range	Resolution	No. of Setting Ring	Extension Rod Length	(mm)		Accuracy	Price (F)
					L	L1		
4511-6205	0.275-0.5"/6-12mm	0.00005"/0.001mm	2pc-8,10mm	100mm	1.5	54.5	0.004mm	1,718.81
4511-6210	0.5-0.8"/12-20mm	0.00005"/0.001mm	1pc-16mm	150mm	0.5	80	0.004mm	1,104.92
4511-6215	0.8-2"/20-50mm	0.00005"/0.001mm	2pc-25,40mm	150mm	0.5	90.97	0.004mm	2,332.72
4511-6220	2-4"/50-100mm	0.00005"/0.001mm	2pc-62,87mm	150mm	0.5	114	0.005mm	2,701.09

INTERNAL GAGING

18PC PRECISION ANGLE GAGE SET

- Stainless steel and satin chrome finished.
- Each gage has eight gauging surfaces.
- Quick inspection of angles and I.D. or O.D. chamfers-in or out of the machine.
- Each gage checks primary, 1/2 primary and complementary angles.
- Supplied with pouch.



Item#	Primary Angle	Price (F)
4901-0045	5°~ 90° by 5°	46.46

PRECISION RADIUS GAGE SETS

- Five different gauging surfaces on each gage for both convex and concave radius.
- Made of satin finish stainless steel-rust and stain resistant.
- With handy gage holders.



Item#	Set	Range	Price (F)
4901-0040	25pc	1/64"-17/64" x 64ths and 9/32"-1/2" x 32nds	42.34
4901-0026	26pc	0.010-0.500"	46.95
4901-0044	10pc	0.55-1.00" by 0.05"	76.19
4901-0047	26pc	0.5-13mm by 0.5mm	42.34

8PC RADIUS GAGE SETS

- Each gage has five measuring surface for checking radius, convex and concave radii easily
- Satin chrome finish and each gage size is marked



Item#	Range	Price (F)
4901-0041	9/16~1" by 16ths	83.16
4901-0042	1-1/16~1-1/2" by 16ths	122.50

35PC GAGE SET



4400-1035
\$79.80 (F)

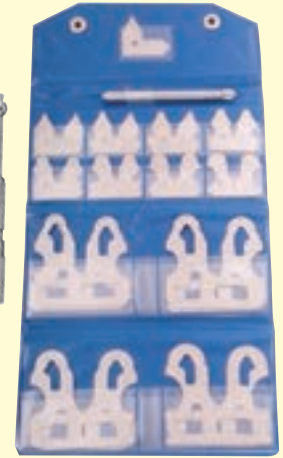

INCLUDES:

- **TELESCOPING GAGE SET** 6 PC 5/16-6" Range #4200-0255
- **SMALL HOLE GAGE SET** 4 PC .125-.500" Range #4400-0009
- **RADIUS GAGE SET** 25 PC 1/61-1/2" Range #4901-0040

CENTER GAGES

- Graduated in 14ths and 20ths on one side and 24ths and 32nds on the other
- Micro-fine graduations
- Accuracy meets Federal Specifications.



Whitworth or English Standard 55°
4901-0061
\$5.79 (F)

Standard 60°
4901-0060
\$5.08 (F)

HIP PRO-SERIES
Standard 60°
4901-0059
\$16.67 (E)

CONCAVE & CONVEX RADIUS GAGES



Item#	Radius Range	Concave Blade	Convex Blade	Price (E)
4901-0102	17/64 -1/2" x 1/32	16	16	14.14
4901-0103	17/32 -1" x 1/32	16	16	13.04

SATIN FINISH, STAINLESS STEEL - RUST, AND STAIN RESISTANT



Dasqua® RADIUS GAGE

- For testing of raised and recessed curves.
- Fine cutted forms.
- Both concave and convex shaped blades become a pair.
- Radius size is marked on each gauge.
- With a locking clamp.

Item#	Range	Step	Leaves Convex(Pcs)	Leaves Concave(Pcs)	Price (F)
1352-1005	1/32"-1/4"	1/64"	15	15	16.98

THREAD GAGING

29° ACME SCREW THREAD GAGES

- Standard for grinding and setting tools when cutting Acme threads.
- Angle & edges are hardened and precision ground.
- Threads: 1, 1-1/3, 1-1/2, 1-3/4, 2, 2-1/2, 3, 4, 5, 6, 7, 8, 9 & 10.



4901-0031
\$1863
(F)



4901-0032
\$3312
(E)

* Limited Supply

29° ACME SCREW THREAD PITCH GAGE-15 BLADES



- Made of tool steel hardened and precision ground
- Pitch number marked on each blade
- Threads: 1, 1-1/3, 1-1/2, 1-3/4, 2, 2-1/2, 3, 3-1/2, 4, 5, 6, 7, 8, 9 & 10
- Blades length: 3"

4901-0033
\$3646
(F)

7-IN-1 MULTI-PURPOSE GAUGE

- Made of tool steel with black coating
- Laser engraved markings.
- 7-IN-1 Combine: Wire Gauge, Drill Sizes, Drill Point Gauge, Screw Pitch Gauge, Bore Gauge, Ruler & Protractor
- Tap/Drill recommendation chart included.
- Wire Gauge: 0.024-0.25"
- Drill Sizes: #5, 6, 8, 10, 12, 1/4", 5/16", 3/8", 7/16", 1/2", 9/16", 5/8" & 3/4"
- Drill Points: 60°, 90°, 118° & 135°
- Screw Pitch Gauge: 40th, 32nd, 24th, 20th, 18th, 16th, 14th, 13th, 12nd, 11th & 10th TPI
- Bore Gauge: 1/64-1/2"
- Ruler: 2-1/2" (32nd)
- Protractor: 15°, 30°, 45°, 60° & 90°
- Vinyl pouch included.



6-5/8" Long x 3-1/2" Wide

4901-0055
\$1814
(F)

THREAD DETECTIVE/IDENTIFIER - Inch & Metric

- Nut and bolt thread identifier. Each size has a nut and bolt checker on the same gauge.
- Inch nut and bolt sizes include #6-32, #8-32, #10-32, #10-24, 1/4-28, 1/4-20, 5/16-24, 5/16-18, 3/8-24, 3/8-16, 7/16-20, 7/16-14, 1/2-20 & 1/2-13
- Metric Nut and bolt sizes include M4x0.7, M5x0.8, M6x1.0, M7x1.0, M8x1.0, M8x1.25, M10x1.0, M10x1.25, M10x1.50, M12x1.25, M12x1.50 & M12x1.75
- Thread sizes are etched on each gauge
- The individual gauges rotate freely on the wire cable for fast thread verification
- Wire cable with loop for convenient hanging



4901-0035
\$2945
(F)

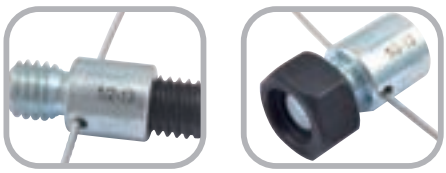

36-0 WIRE MEASURING GAGES

- For measuring wire diameter and non-ferrous sheets such as copper, brass, aluminum, etc.
- Measures gauge no. from 36 to 0 (.003 ~.3125).
- Made of hardened steel and satin chrome finish.
- Marks of wire size on front, decimal equivalents on reverse side
- Complete in vinyl pouch.

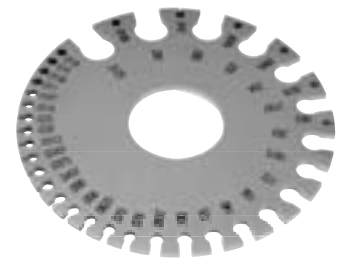

* Limited Supply

4901-0048
\$3206
(F)

4901-0049
\$4054
(E)

WIRE MEASURING GAUGE - Rectangular Shape

- For measuring wire diameter and non-ferrous sheets such as copper, brass, aluminum, etc.
- Measures gauge no. from 36 to 0 (.003 ~.3125).
- Made of stainless steel.
- Eched marks of wire size and decimal equivalents on front side.
- Complete in vinyl pouch.

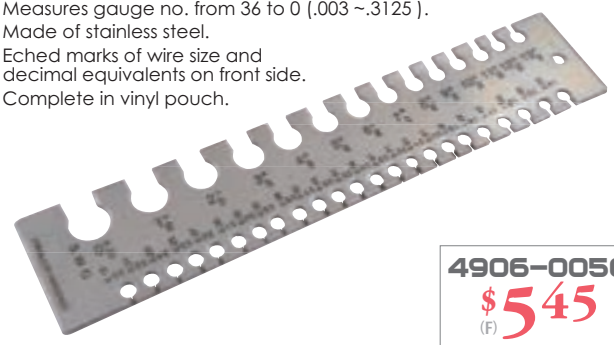

4906-0050
\$545
(F)

PRECISION MEASURING TOOLS

THREAD GAGING

THREAD PLUG GAGES & RING GAGES

- Gages are made in "X" tolerance
- Classes 2A and 2B for Inch, classes 6H and 6G for MM most commonly used for general applications including bolts, nuts, screws and similar fasteners



Metric Plug Gages GO-NOGO with Handle Class 6H			Ring Gages GO-NOGO Class 6G	
Size	Item#	Price (E)	Item#	Price (E)
M2 x 0.4	4101-1102	46.72	4101-1202	101.93
M3 x 0.5	4101-1103	46.72	4101-1203	84.48
M2.5 x 0.45	4101-1125	42.90	4101-1225	75.21
M3.5 x 0.6	4101-1135	42.90	4101-1235	75.21
M4 x 0.7	4101-1104	33.24	4101-1204	86.13
M5 x 0.8	4101-1105	33.24	4101-1205	86.13
M6 x 1.0	4101-1106	33.24	4101-1206	86.13
M7 x 1.0	4101-1107	33.29	4101-1207	87.23
M8 x 1.25	4101-1108	33.24	4101-1208	87.23
M10 x 1.25	4101-1110	38.00	4101-1210	87.23
M10 x 1.50	4101-1111	38.00	4101-1211	87.23
M12 x 1.75	4101-1112	38.00	4101-1212	87.23
M14 x 2.0	4101-1114	40.08	4101-1214	88.76
M16 x 2.0	4101-1116	40.08	4101-1216	88.76
M18 x 2.50	4101-1118	50.15	4101-1218	88.76
M20 x 2.50	4101-1120	50.15	4101-1220	88.76
M22 x 2.50	4101-1122	42.80	4101-1222	99.19
M24 x 3.0	4101-1124	52.80	4101-1224	104.70

PRICED & SOLD BY SET

Inch Plug Gages GO-NOGO with Handle Class 2B			Ring Gages GO-NOGO Class 2A	
Size	Item#	Price (E)	Item#	Price (E)
4-40UNC	4101-0208	61.20	4101-0308	102.84
5-40UNC	-----	----	4101-0310	100.36
6-32UNC	4101-0212	58.52	4101-0312	97.16
8-32UNC	4101-0214	58.52	4101-0314	97.16
10-24UNC	4101-0216	61.24	4101-0316	97.16
10-32UNF	4101-0217	54.88	4101-0317	97.16
1/4-20UNC	4101-0221	54.88	4101-0321	97.16
1/4-28UNF	4101-0222	54.88	4101-0322	97.16
5/16-18UNC	4101-0224	54.88	4101-0324	89.76
5/16-24UNF	4101-0225	54.88	4101-0325	89.76
3/8-16UNC	4101-0227	54.88	4101-0327	89.76
3/8-24UNF	4101-0228	61.24	4101-0328	89.76
7/16-14UNC	4101-0230	61.24	4101-0330	89.76
7/16-20UNF	4101-0231	61.24	4101-0331	89.76
1/2-13UNC	4101-0233	61.24	4101-0333	98.44
1/2-20UNF	4101-0234	66.00	4101-0334	98.44

7PC THREAD PLUG GAGE SETS

- Gages are made in "X" tolerance
- Class 2B for Inch, Class 6H MM set.
- Fitted ABS case included.



7PC Inch Set
4101-0260
\$310²³
(E)

Includes: 8-32, 10-24, 1/4-20, 5/16-18, 3/8-16, 7/16-14 & 1/2-13

7PC Metric Set
4101-1171
\$202⁸⁰
(E)

Includes: M3x0.5, M4x0.7, M5x0.8, M6x1.0, M8x1.25, M10x1.5 & M12x1.75

SCREW PITCH GAGES

- Correct pitch is determined by matching blade teeth with threaders.
- Each blade clearly marked with proper thread size.
- Blades protected in sturdy steel case.
- Plastic pouch.
- Combination of 31 American National 60° and 24 Metric 60° thread leaves.



Item#	Thread Range	No. of Leaves	No. of Groups	Price (F)
4901-0030	4~42 TPI 60° & .25~6mm 60°	55	2	15.82

SCREW PITCH GAGES

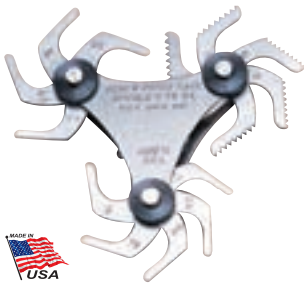

- Narrow designed blades permit use for internal and external screw threads.
- Correct pitch is determined by matching blade teeth with threads.
- Locking device at each end secures all blades for storage, or positions an individual blade for use.
- Each blade clearly marked with proper thread size
- Blades protected in sturdy steel case.

Item#	Thread Range	No. of Blades	No. of Groups	Price (E)
4901-0094	4~84 TPI 60°	51	3	72.82
4901-0095	4~56 TPI & .50~6.00mm	28	2	37.25
4901-0096	0.25~2.50mm	28	2	37.25
4901-0097	0.50~7.00mm	18	2	31.90

SCREW PITCH GAGES

- Correct pitch is determined by matching blade teeth with threaders.
- Each blade clearly marked with proper thread size.
- Blades protected in sturdy steel case.
- Narrow designed blade permits use for internal and external screw threads.

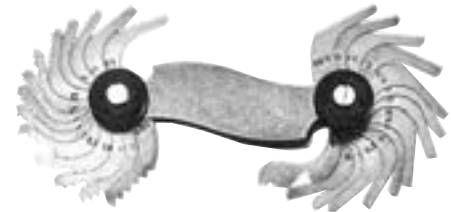

Item#	Thread Range	No. of Leaves	No. of Groups	Price (F)
4901-0028	.25~2.5mm 60°	28	2	12.54
4901-0029	0.5~7.0mm 60°	17	2	9.98
4901-0037	4~84 TPI 60°	51	2	14.92
4901-0038	4~62 TPI 55° & .25~6mm 60°	52	2	15.37
4901-0030	4~42 TPI 55° & .25~6mm 60°	55	2	15.82

Pro-Series 6PC TELESCOPING GAGE SET

- Double action (self centering) for quick checking of inside measurements.
- Smooth movement.
- Satin chrome finish.
- Constant spring tension for uniform feel.
- Contact point ends are hardened tool steel and precision ground on a radius of the smallest hole the gage will enter.
- Includes shop-hardened case.



6PC Set
5/16~6" Range
4209-0255
\$3995
(F)

Standard 6pc Set

(Inch) Set Range	OAL
5/16~1/2	4.20
1/2~3/4	4.40
3/4~1-1/4	4.40
1-1/4~2-1/8	5.85
2-1/8~3-1/2	5.85
3-1/2~6.0	5.85



Pro-Series 6PC LONG-REACH TELESCOPING GAGE SET

- Double action (self centering) for quick checking of inside measurements.
- Smooth movement, rigid handle with self-centering feature.
- Satin chrome finish.
- Constant spring tension for uniform feel.
- Contact point ends are hardened tool steel and precision ground on a radius of the smallest hole the gage will enter.
- Includes a fitted case.

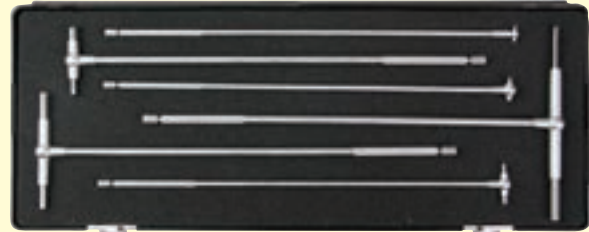

Long-Reach 6pc Set

(Inch) Set Range	OAL
5/16~1/2	12"/300mm
1/2~3/4	12"/300mm
3/4~1-1/4	12"/300mm
1-1/4~2-1/8	12"/300mm
2-1/8~3-1/2	12"/300mm
3-1/2~6.0	12"/300mm

12" LONG REACH SET
6PC Set, 5/16~6" Range
4209-0266
\$6555
(F)

Dasqua® 12 PC TELESCOPING GAUGE COMBO SET

- Durable action (self-centering) for quick checking of inside measurements.
- Great tool for easy and accurate measurements of the true sizes of holes and slots.
- Satin chrome finish.
- Rigid handle with self-centering feature.
- Constant spring tension for uniform feel & smooth operation.
- Contact plunger automatically self-centering at all times and in all positions.
- Contact point ends are hardened tool steel and precision ground on a radius of the smallest hole the gage will enter.
- Includes fitted case.



Standard Set
(Up To 5.85") Shown

COMBO SET
FOR EASY ACCESS
TO MEASUREMENTS!

12PC Combo Set
5911-9999
\$10795
(F)

Standard 6pc Set

(Inch) Set Range	OAL
5/16~1/2	4.20
1/2~3/4	4.40
3/4~1-1/4	4.40
1-1/4~2-1/8	5.85
2-1/8~3-1/2	5.85
3-1/2~6.0	5.85

Long-Reach 6pc Set

(Inch) Set Range	OAL
5/16~1/2	12"/300mm
1/2~3/4	12"/300mm
3/4~1-1/4	12"/300mm
1-1/4~2-1/8	12"/300mm
2-1/8~3-1/2	12"/300mm
3-1/2~6.0	12"/300mm

Long Reach Set
(Up To 12") Shown

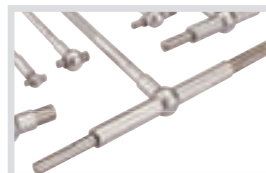

Includes

Item#	Set	Range	Depth	Price (F)
5911-0001	6PC Long Reach Set	5/16-1/2", 1/2-3/4", 3/4-1-1/4", 1-1/4-2-1/8", 2-1/8-3-1/2", 3-1/2-6"	up to 12"	72.10
5911-0002	6PC Standard reach set	5/16-1/2", 1/2-3/4", 3/4-1-1/4", 1-1/4-2-1/8", 2-1/8-3-1/2", 3-1/2-6"	up to 5.85"	42.25

INTERNAL GAGING

TELESCOPING GAGE & SETS

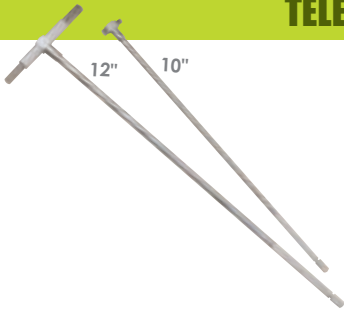

4200-0255 Shown

- Double action (self centering) for quick checking of inside measurements.
- Satin chrome finish.
- Vinyl pouch included.
- Constant spring tension for uniform feel.
- Contact point ends are hardened tool steel and precision ground on a radius of the smallest hole the gage will enter.

STANDARD SET
6PC Set, 5/16~6" Range
4200-0255
\$**31.76**
(F)

Long Reach Set

Set Range	10" Long Reach	12" Long Reach
5/16~1/2"	1/2~3/4"	1-1/4~2-1/8"
1/2~3/4"	3/4~1-1/4"	2-1/8~3-1/2"
3/4~1-1/4"		3-1/2~6.0"

10" LONG REACH SET
3PC Set, 5/16~1-1/4" Range
4200-0260*
\$**21.63**
(F)

* Limited Supply

12" LONG REACH SET
3PC Set, 1-1/4~6" Range
4200-0262*
\$**25.12**
(F)

Standard Length Set

(Inch)	OAL
5/16~1/2	4.20
1/2~3/4	4.40
3/4~1-1/4	4.40
1-1/4~2-1/8	5.85
2-1/8~3-1/2	5.85
3-1/2~6.0	5.85

INTERNAL DIAL CALIPER GAGE

- 0~1" movement to check recessed diameters, internal bores, etc.
- Bezel can be rotated for zero setting and can be locked with screw.
- Set with micrometers or a ring gage.
- Carbide ball measuring points: 0.09" x 0.09"
- Button: push to close arms.
- Arm Length: 3.25"
- Arm Thickness: 0.09"

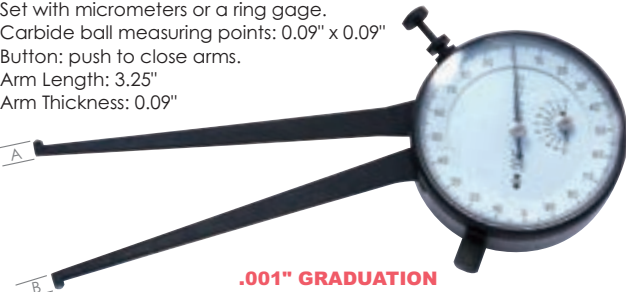

.001" GRADUATION

Item#	Range	Graduation	A	B	Price (F)
4400-0801	0.375" ~1.375"	0.001"	5/32"	5/32"	106.34

4PC SMALL HOLE GAGE SET - Full Ball

- Easy to adjust with full spherical, hardened, satin-chrome plated measuring faces.
- Set furnished in plastic pouch.

.125~.500" RANGE

Full Ball
4400-0009
\$**20.44**
(F)



Pro-Series SPRING DIVIDERS



- Easy adjustment over entire range.
- Balanced legs, uniform tension.
- Polished natural steel finish.

Size	Item#	Price (F)
4"	4901-0065	9.90
6"	4901-0066	11.00
8"	4901-0067	15.73
10"	4901-0068	19.09
12"	4901-0069	22.53

Pro-Series INSIDE CALIPERS

- Easy adjustment over entire range.
- Balanced legs, uniform tension.
- Polished natural steel finish.



Size	Item#	Price (F)
6"	4901-0070	11.52
8"	4901-0071	14.40
12"	4901-0072	20.90

Pro-Series OUTSIDE CALIPERS

- Easy adjustment over entire range.
- Balanced legs, uniform tension.
- Polished natural steel finish.



Size	Item#	Price (F)
6"	4901-0073	11.00
8"	4901-0074	15.20
12"	4901-0075	20.44

Dasqua® SMALL HOLE GAUGE SET

- Measuring range: 3-5mm, 5-7.5mm, 7.5-10mm, 10-13mm.
- Used with an outside micrometer for measuring inside diameter of bores.
- Gaging surface is fully hardened to ensure long tool life.
- Extra long for gaging deep and shallow holes, slots, and similar workpieces.
- Satin chrome finish - full ball.



NEW

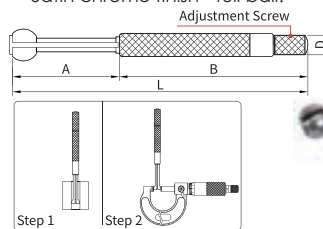

Item#	Each Measuring Range	(mm)				Price (F)
		L	A	B	D	
5921-0005	3-5mm / .125"-.200"	76	22	53	Ø5	24.48
	5-7.5mm / .200"-.300"	78	24	53	Ø5	
	7.5-10mm / .300"-.400"	88	28	59	Ø6	
	10-13mm / .400"-.500"	92	32	59	Ø6	

.0005" GRADUATION DIAL BORE GAGE SETS

- For close tolerance measurements of holes, taper and roundness.
- Gages are supplied with AGD Group II dial indicator.
- Easy setting with micrometers or ring gages.
- Fitted case with anvils index.
- Self centering.

.0005" GRADUATION DIAL INDICATOR



2~6" Range
4400-0007
\$1067³
(E)

0~0.25" Range
.0005" Graduation
Replacement Indicator
4400-1252
\$219⁷
(F)

Item#	Range	Probe Depth	No. of Anvils	Price (F)
4400-0061	0.24 - 0.4"	2"	9	141.08
4400-0062	0.4 - 0.7"	4"	11	139.39
4400-0063	0.7 - 1.5"	6"	9	111.18
4400-0064	1.4 - 2.4"	6"	6	107.33
4400-0007	2.0 - 6.0"	6"	11	106.73
4400-1406	1.4 - 6.0"	6"	17	171.88

0~6" BORE GAGE SETTING MASTER

- Bore Gage Setting Master Kit is used for accurately setting any bore gage up to 6" inch.
- Each Set includes:
 - 1- Setting Device
 - Base anvil: 2.750" x .80"
 - Adjustable anvil 2.375" x .375" (two each)
 - Baseanvil: 2.750"
 - Internal capacity: 6"
 - Depth capacity: 1"
 - Centralizer capacity width: 2.625"
 - Quick-release holder for fast adjustment
 - 1- Economy Gage Block Set
 - 36 piece
 - Tolerances to .00005"
 - Certificate of Calibration to N.I.S.T.
 - High quality wooden case



4400-0070
\$428⁶⁴
(F)



Operating Instructions



Dasqua® .0005" GRADUATION DIAL BORE GAGE SETS

- Self centering.
- Carbide anvils.
- Easy-to-read.
- Insulated cover.
- Chrome plated handle.
- Includes extension holder and fitted case.

.0005" GRADUATION

The Biggest Measuring Range Set In Industry!
Two Popular Bore Gauge Ranges Combined In One Set!

1.4~6" Range
5510-0000
\$207⁷⁷
(F)



5512-6130 Shown

Item#	Measuring Range	Depth Up to	Price (F)
5512-6105	0.24-0.4"	1.55"	175.94
5512-6110	0.4-0.7"	4"	170.51
5512-6115	0.7-1.5"	6"	132.63
5512-6120	1.4-2.4"	6"	132.63
5512-6125	2-4"	6"	132.63
5512-6130	2-6"	6"	128.83
5510-0000	1.4-6"	6"	207.77



INTERNAL GAGING

PRECISION STEEL PIN GAGE SETS -Inch

- Supplied in a plastic, sturdy, dust-proof fitted case.
- Sizes marked on case for easy identification.
- Fully hardened to 60-62 RC.
- Finish to 10 Micron or better.
- Class ZZ
- OAL: 2" .



Minus Set
.061~.250" Range
4101-0011
\$8208
 (F)

Size	SET	Item#	Price (F)
MINUS SETS (-) -0.0002" + 0.0000"			
0.011~0.060"	50pc	4101-0010	36.26
0.061~0.250"	190pc	4101-0011	82.08
0.251~0.500"	250pc	4101-0012	165.94
0.501~0.625"	125pc	4101-0013	173.50
0.626~0.750"	125pc	4101-0014	207.93
0.751~0.832"	82pc	4101-0015	226.82
0.833~0.916"	84pc	4101-0016	274.48
0.917~1.000"	84pc	4101-0017	264.63
PLUS SETS (+) -0.0000" + 0.0002"			
0.061~0.250"	190pc	4101-0111	75.77
0.251~0.500"	250pc	4101-0112	150.85

PRECISION PIN GAGE M1&M2 SET -Inch

- Supplied in a plastic, sturdy, dust-proof fitted case.
- Sizes marked on case for easy identification.
- Fully hardened to 60-62 RC.
- Finish to 10 Micron or better.
- Class ZZ
- OAL: 2" .

Accuracy -0.0002" + 0.0000" (Minus)



440 PC SET
.061~.500" Range
4101-0050
\$22061
 (F)

Pro-Series BLACK-OXIDE STEEL PIN GAGE SET -Large Range

- Certified set, traceable to N.I.S.T.
- Supplied in a plastic, sturdy, dust-proof fitted case.
- Sizes marked on case for easy identification.
- Black-oxide finish to 10 Micron or better.
- Hardened to 60-62 RC.
- Class ZZ
- OAL: 2" .
- 2 handles included.

MINUS SET:
(-)0.0002" (+)0.0000"

Minus Set, 240PC
.0110~.250" Range
4101-0102
\$29307
 (F)



Pro-Series PRECISION STEEL PIN GAGE SETS WITH CERTIFICATION -Inch

- **Certified sets.**
- Supplied in a plastic, sturdy, dust-proof fitted case.
- Sizes marked on case for easy identification.
- Fully hardened to 62-64 RC.
- Finish to 10 Micron or better.
- Class ZZ
- OAL: 2" .

Item#	SET	Size	Price (F)
Accuracy -0.0002" + 0.0000" (Minus)			
4101-0040	50pc	0.011~0.060"	71.98
4101-0041	190pc	0.061~0.250"	143.65
4101-0042	250pc	0.251~0.500"	271.28
4101-0043	125pc	0.501~0.625"	270.15
4101-0044	125pc	0.626~0.750"	308.10
4101-0045	82pc	0.751~0.832"	353.89
4101-0046	84pc	0.833~0.916"	360.90
4101-0047	84pc	0.917~1.000"	444.61

PIN GAGE HANDLE INCLUDED



COMBINATION PIN GAGE SETS WITH HANDLE -Inch

- Supplied in a plastic, sturdy, dust-proof fitted case.
- Sizes marked on case for easy identification.
- Fully hardened to 60-62 RC.
- Finish to 10 Micron or better.
- Class ZZ
- OAL: 2" .



MINUS SETS (-) -0.0002" + 0.0000"

Size	SET	Item#	Price (F)
0.011~0.1000"	90pc	4103-3001	142.95
0.101~0.200"	100pc	4103-3003	142.95
0.201~0.300	100pc	4103-3005	171.55
0.301~0.400"	100pc	4103-3007	171.55

PIN GAGE HANDLES

- Comfortable, ergonomically made handle for pin gages.
- Made from aluminum and powder coated.
- Can be used with GO pin (green) on one end, NO GO pin (red) on opposite end.

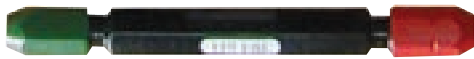

Item#	For Pin Gage	Price (E)
4102-0001	.011 ~ .060"	12.60
4102-0002	.061 ~ .250"	15.78
4102-0003	.251 ~ .500"	18.93
4102-0006*	.751 ~ .832"	25.25
4102-0007*	.833 ~ .916"	28.43
4102-0008*	.917 ~ 1.000"	31.58

* Limited Supply

Pro-Series PIN GAGE HANDLE 1/32-1/2"

- For pin gage sizes: 1/32~1/2"
- Casting aluminum
- Go and No-Go clearly marked
- Large capacity.



4102-0020
\$24.99
(F)

PIN GAGE HANDLE 1/32-1/2"

- For pin gage sizes: 1/32~1/2"
- Casting aluminum
- Go and No-Go clearly marked
- Large capacity.



4106-0020
\$12.63
(F)

Pro-Series PRECISION STEEL PIN GAGE SETS WITH CERTIFICATION -Metric

- Certified sets
- Supplied in a plastic, sturdy, dust-proof fitted case.
- Sizes marked on case for easy identification.
- Fully hardened to 62-64 RC.
- Finish to 10 Micron or better.
- Class ZZ
- OAL: 2" .



PIN GAGE HANDLE INCLUDED

Item#	Set	Size	Price (F)
Accuracy - 0.005mm + 0.000mm (Minus)			
4101-1010	55pc	0.20~1.28mm	78.23
4101-1011	55pc	0.21~1.29mm	84.25
4101-1012	185pc	1.30~4.98mm	212.32
4101-1013	185pc	1.31~4.99mm	212.32
4101-1014	250pc	5.00~9.98mm	293.98
4101-1015	250pc	5.01~9.99mm	293.98
4101-1016	200pc	10.00~13.98mm	326.66
4101-1017	200pc	10.01~13.99mm	326.66

Pro-Series PLUG GAGE HANDLES

- SPI style.
- Superior finish and smooth operation.
- Holds pin gage with greatest gripping power.
- Can be used with GO pin (green) and NO GO pin (red).
- Comfortable and ergonomically designed handle for pin gages.
- No bushings required.



Item #	Pin Gage Range (inch)		Price (F)
	Min.	Max.	
4102-0011	0.011	0.060	27.45
4102-0012	0.061	0.250	27.45
4102-0013	0.251	0.500	33.82
4102-0014	0.501	0.625	35.70
4102-0015	0.626	0.750	45.33

PIN GAGE SET REPLACEMENT CASES

NEW

- Plastic, sturdy, dust-proof case.
- Sizes marked on case for easy identification.
- Good for minus and plus pin gage sets.
- For pin gage overall length 2" .



Pin Gages Not Included



190pc Replacement Case
.061~.250" Range
4101-0011CASE
\$22.48
(F)

250pc Replacement Case
.251~.500" Range
4101-0012CASE
\$31.59
(F)

INTERNAL GAGING

INDIVIDUAL CLASS ZZ PIN GAGES

- Replace missing, damaged, or worn-out Class ZZ gages from existing sets and libraries.
- Each pin is individually marked with size.
- Fully hardened to 60-62 RC.

- Finish to 10 Micron or better.
- Overall Length: 2"
- Tolerance: Minus .0002"



Item#	Size	Price(F)	Item#	Size	Price(F)	Item#	Size	Price(F)	Item#	Size	Price(F)	Item#	Size	Price(F)	Item#	Size	Price(F)
4103-0011	0.011	2.73	4103-0094	0.094	2.85	4103-0177	0.177	2.85	4103-0260	0.260	5.49	4103-0343	0.343	5.49	4103-0426	0.426	5.49
4103-0012	0.012	2.73	4103-0095	0.095	2.85	4103-0178	0.178	2.85	4103-0261	0.261	5.49	4103-0344	0.344	5.49	4103-0427	0.427	5.49
4103-0013	0.013	2.73	4103-0096	0.096	2.85	4103-0179	0.179	2.85	4103-0262	0.262	5.49	4103-0345	0.345	5.49	4103-0428	0.428	5.49
4103-0014	0.014	2.73	4103-0097	0.097	2.85	4103-0180	0.180	2.85	4103-0263	0.263	5.49	4103-0346	0.346	5.49	4103-0429	0.429	5.49
4103-0015	0.015	2.73	4103-0098	0.098	2.85	4103-0181	0.181	2.85	4103-0264	0.264	5.49	4103-0347	0.347	5.49	4103-0430	0.430	5.49
4103-0016	0.016	2.73	4103-0099	0.099	2.85	4103-0182	0.182	2.85	4103-0265	0.265	5.49	4103-0348	0.348	5.49	4103-0431	0.431	5.49
4103-0017	0.017	2.73	4103-0100	0.100	2.85	4103-0183	0.183	2.85	4103-0266	0.266	5.49	4103-0349	0.349	5.49	4103-0432	0.432	5.49
4103-0018	0.018	2.73	4103-0101	0.101	2.85	4103-0184	0.184	2.85	4103-0267	0.267	5.49	4103-0350	0.350	5.49	4103-0433	0.433	5.49
4103-0019	0.019	2.73	4103-0102	0.102	2.85	4103-0185	0.185	2.85	4103-0268	0.268	5.49	4103-0351	0.351	5.49	4103-0434	0.434	5.49
4103-0020	0.020	2.73	4103-0103	0.103	2.85	4103-0186	0.186	2.85	4103-0269	0.269	5.49	4103-0352	0.352	5.49	4103-0435	0.435	5.49
4103-0021	0.021	2.73	4103-0104	0.104	2.85	4103-0187	0.187	2.85	4103-0270	0.270	5.49	4103-0353	0.353	5.49	4103-0436	0.436	5.49
4103-0022	0.022	2.73	4103-0105	0.105	2.85	4103-0188	0.188	2.85	4103-0271	0.271	5.49	4103-0354	0.354	5.49	4103-0437	0.437	5.49
4103-0023	0.023	2.73	4103-0106	0.106	2.85	4103-0189	0.189	2.85	4103-0272	0.272	5.49	4103-0355	0.355	5.49	4103-0438	0.438	5.49
4103-0024	0.024	2.73	4103-0107	0.107	2.85	4103-0190	0.190	2.85	4103-0273	0.273	5.49	4103-0356	0.356	5.49	4103-0439	0.439	5.49
4103-0025	0.025	2.73	4103-0108	0.108	2.85	4103-0191	0.191	2.85	4103-0274	0.274	5.49	4103-0357	0.357	5.49	4103-0440	0.440	5.49
4103-0026	0.026	2.73	4103-0109	0.109	2.85	4103-0192	0.192	2.85	4103-0275	0.275	5.49	4103-0358	0.358	5.49	4103-0441	0.441	5.49
4103-0027	0.027	2.73	4103-0110	0.110	2.85	4103-0193	0.193	2.85	4103-0276	0.276	5.49	4103-0359	0.359	5.49	4103-0442	0.442	5.49
4103-0028	0.028	2.73	4103-0111	0.111	2.85	4103-0194	0.194	2.85	4103-0277	0.277	5.49	4103-0360	0.360	5.49	4103-0443	0.443	5.49
4103-0029	0.029	2.73	4103-0112	0.112	2.85	4103-0195	0.195	2.85	4103-0278	0.278	5.49	4103-0361	0.361	5.49	4103-0444	0.444	5.49
4103-0030	0.030	2.73	4103-0113	0.113	2.85	4103-0196	0.196	2.85	4103-0279	0.279	5.49	4103-0362	0.362	5.49	4103-0445	0.445	5.49
4103-0031	0.031	2.73	4103-0114	0.114	2.85	4103-0197	0.197	2.85	4103-0280	0.280	5.49	4103-0363	0.363	5.49	4103-0446	0.446	5.49
4103-0032	0.032	2.73	4103-0115	0.115	2.85	4103-0198	0.198	2.85	4103-0281	0.281	5.49	4103-0364	0.364	5.49	4103-0447	0.447	5.49
4103-0033	0.033	2.73	4103-0116	0.116	2.85	4103-0199	0.199	2.85	4103-0282	0.282	5.49	4103-0365	0.365	5.49	4103-0448	0.448	5.49
4103-0034	0.034	2.73	4103-0117	0.117	2.85	4103-0200	0.200	2.85	4103-0283	0.283	5.49	4103-0366	0.366	5.49	4103-0449	0.449	5.49
4103-0035	0.035	2.73	4103-0118	0.118	2.85	4103-0201	0.201	2.85	4103-0284	0.284	5.49	4103-0367	0.367	5.49	4103-0450	0.450	5.49
4103-0036	0.036	2.73	4103-0119	0.119	2.85	4103-0202	0.202	2.85	4103-0285	0.285	5.49	4103-0368	0.368	5.49	4103-0451	0.451	5.49
4103-0037	0.037	2.73	4103-0120	0.120	2.85	4103-0203	0.203	2.85	4103-0286	0.286	5.49	4103-0369	0.369	5.49	4103-0452	0.452	5.49
4103-0038	0.038	2.73	4103-0121	0.121	2.85	4103-0204	0.204	2.85	4103-0287	0.287	5.49	4103-0370	0.370	5.49	4103-0453	0.453	5.49
4103-0039	0.039	2.73	4103-0122	0.122	2.85	4103-0205	0.205	2.85	4103-0288	0.288	5.49	4103-0371	0.371	5.49	4103-0454	0.454	5.49
4103-0040	0.040	2.73	4103-0123	0.123	2.85	4103-0206	0.206	2.85	4103-0289	0.289	5.49	4103-0372	0.372	5.49	4103-0455	0.455	5.49
4103-0041	0.041	2.73	4103-0124	0.124	2.85	4103-0207	0.207	2.85	4103-0290	0.290	5.49	4103-0373	0.373	5.49	4103-0456	0.456	5.49
4103-0042	0.042	2.73	4103-0125	0.125	2.85	4103-0208	0.208	2.85	4103-0291	0.291	5.49	4103-0374	0.374	5.49	4103-0457	0.457	5.49
4103-0043	0.043	2.73	4103-0126	0.126	2.85	4103-0209	0.209	2.85	4103-0292	0.292	5.49	4103-0375	0.375	5.49	4103-0458	0.458	5.49
4103-0044	0.044	2.73	4103-0127	0.127	2.85	4103-0210	0.210	2.85	4103-0293	0.293	5.49	4103-0376	0.376	5.49	4103-0459	0.459	5.49
4103-0045	0.045	2.73	4103-0128	0.128	2.85	4103-0211	0.211	2.85	4103-0294	0.294	5.49	4103-0377	0.377	5.49	4103-0460	0.460	5.49
4103-0046	0.046	2.73	4103-0129	0.129	2.85	4103-0212	0.212	2.85	4103-0295	0.295	5.49	4103-0378	0.378	5.49	4103-0461	0.461	5.49
4103-0047	0.047	2.73	4103-0130	0.130	2.85	4103-0213	0.213	2.85	4103-0296	0.296	5.49	4103-0379	0.379	5.49	4103-0462	0.462	5.49
4103-0048	0.048	2.73	4103-0131	0.131	2.85	4103-0214	0.214	2.85	4103-0297	0.297	5.49	4103-0380	0.380	5.49	4103-0463	0.463	5.49
4103-0049	0.049	2.73	4103-0132	0.132	2.85	4103-0215	0.215	2.85	4103-0298	0.298	5.49	4103-0381	0.381	5.49	4103-0464	0.464	5.49
4103-0050	0.050	2.73	4103-0133	0.133	2.85	4103-0216	0.216	2.85	4103-0299	0.299	5.49	4103-0382	0.382	5.49	4103-0465	0.465	5.49
4103-0051	0.051	2.73	4103-0134	0.134	2.85	4103-0217	0.217	2.85	4103-0300	0.300	5.49	4103-0383	0.383	5.49	4103-0466	0.466	5.49
4103-0052	0.052	2.73	4103-0135	0.135	2.85	4103-0218	0.218	2.85	4103-0301	0.301	5.49	4103-0384	0.384	5.49	4103-0467	0.467	5.49
4103-0053	0.053	2.73	4103-0136	0.136	2.85	4103-0219	0.219	2.85	4103-0302	0.302	5.49	4103-0385	0.385	5.49	4103-0468	0.468	5.49
4103-0054	0.054	2.73	4103-0137	0.137	2.85	4103-0220	0.220	2.85	4103-0303	0.303	5.49	4103-0386	0.386	5.49	4103-0469	0.469	5.49
4103-0055	0.055	2.73	4103-0138	0.138	2.85	4103-0221	0.221	2.85	4103-0304	0.304	5.49	4103-0387	0.387	5.49	4103-0470	0.470	5.49
4103-0056	0.056	2.73	4103-0139	0.139	2.85	4103-0222	0.222	2.85	4103-0305	0.305	5.49	4103-0388	0.388	5.49	4103-0471	0.471	5.49
4103-0057	0.057	2.73	4103-0140	0.140	2.85	4103-0223	0.223	2.85	4103-0306	0.306	5.49	4103-0389	0.389	5.49	4103-0472	0.472	5.49
4103-0058	0.058	2.73	4103-0141	0.141	2.85	4103-0224	0.224	2.85	4103-0307	0.307	5.49	4103-0390	0.390	5.49	4103-0473	0.473	5.49
4103-0059	0.059	2.73	4103-0142	0.142	2.85	4103-0225	0.225	2.85	4103-0308	0.308	5.49	4103-0391	0.391	5.49	4103-0474	0.474	5.49
4103-0060	0.060	2.73	4103-0143	0.143	2.85	4103-0226	0.226	2.85	4103-0309	0.309	5.49	4103-0392	0.392	5.49	4103-0475	0.475	5.49
4103-0061	0.061	2.85	4103-0144	0.144	2.85	4103-0227	0.227	2.85	4103-0310	0.310	5.49	4103-0393	0.393	5.49	4103-0476	0.476	5.49
4103-0062	0.062	2.85	4103-0145	0.145	2.85	4103-0228	0.228	2.85	4103-0311	0.311	5.49	4103-0394	0.394	5.49	4103-0477	0.477	5.49
4103-0063	0.063	2.85	4103-0146	0.146	2.85	4103-0229	0.229	2.85	4103-0312	0.312	5.49	4103-0395	0.395	5.49	4103-0478	0.478	5.49
4103-0064	0.064	2.85	4103-0147	0.147	2.85	4103-0230	0.230	2.85	4103-0313	0.313	5.49	4103-0396	0.396	5.49	4103-0479	0.479	5.49
4103-0065	0.065	2.85	4103-0148	0.148	2.85	4103-0231	0.231	2.85	4103-0314	0.314	5.49	4103-0397	0.397	5.49	4103-0480	0.480	5.49
4103-0066	0.066	2.85	4103-0149	0.149	2.85	4103-0232	0.232	2.85	4103-0315	0.315	5.49	4103-0398	0.398	5.49	4103-0481	0.481	5.49
4103-0067	0.067	2.85	4103-0150	0.150	2.85	4103-0233	0.233	2.85	4103-0316	0.316	5.49	4103-0399	0.399	5.49	4103-0482	0.482	5.49
4103-0068	0.068	2.85	4103-0151	0.151	2.85	4103-0234	0.234	2.85	4103-0317	0.317	5.49	4103-0400	0.400	5.49	4103-0483	0.483	5.49
4103-0069	0.069	2.85	4103-0152	0.152	2.85	4103											



INDIVIDUAL CLASS ZZ PIN GAGES

- Replace missing, damaged, or worn-out Class ZZ gages from existing sets and libraries.
- Each pin is individually marked with size.
- Fully hardened to 60-62 RC.

- Finish to 10 Micron or better.
- Overall Length: 2"
- Tolerance: Minus .0002"

Item#	Size	Price(F)	Item#	Size	Price(F)	Item#	Size	Price(F)	Item#	Size	Price(F)	Item#	Size	Price(F)	Item#	Size	Price(F)
4103-0509	0.509	6.11	4103-0592	0.592	6.11	4103-0675	0.675	6.50	4103-0758	0.758	8.81	4103-0841	0.841	10.72	4103-0924	0.924	11.51
4103-0510	0.510	6.11	4103-0593	0.593	6.11	4103-0676	0.676	6.50	4103-0759	0.759	8.81	4103-0842	0.842	10.72	4103-0925	0.925	11.51
4103-0511	0.511	6.11	4103-0594	0.594	6.11	4103-0677	0.677	6.50	4103-0760	0.760	8.81	4103-0843	0.843	10.72	4103-0926	0.926	11.51
4103-0512	0.512	6.11	4103-0595	0.595	6.11	4103-0678	0.678	6.50	4103-0761	0.761	8.81	4103-0844	0.844	10.72	4103-0927	0.927	11.51
4103-0513	0.513	6.11	4103-0596	0.596	6.11	4103-0679	0.679	6.50	4103-0762	0.762	8.81	4103-0845	0.845	10.72	4103-0928	0.928	11.51
4103-0514	0.514	6.11	4103-0597	0.597	6.11	4103-0680	0.680	6.50	4103-0763	0.763	8.81	4103-0846	0.846	10.72	4103-0929	0.929	11.51
4103-0515	0.515	6.11	4103-0598	0.598	6.11	4103-0681	0.681	6.50	4103-0764	0.764	8.81	4103-0847	0.847	10.72	4103-0930	0.930	11.51
4103-0516	0.516	6.11	4103-0599	0.599	6.11	4103-0682	0.682	6.50	4103-0765	0.765	8.81	4103-0848	0.848	10.72	4103-0931	0.931	11.51
4103-0517	0.517	6.11	4103-0600	0.600	6.11	4103-0683	0.683	6.50	4103-0766	0.766	8.81	4103-0849	0.849	10.72	4103-0932	0.932	11.51
4103-0518	0.518	6.11	4103-0601	0.601	6.11	4103-0684	0.684	6.50	4103-0767	0.767	8.81	4103-0850	0.850	10.72	4103-0933	0.933	11.51
4103-0519	0.519	6.11	4103-0602	0.602	6.11	4103-0685	0.685	6.50	4103-0768	0.768	8.81	4103-0851	0.851	10.72	4103-0934	0.934	11.51
4103-0520	0.520	6.11	4103-0603	0.603	6.11	4103-0686	0.686	6.50	4103-0769	0.769	8.81	4103-0852	0.852	10.72	4103-0935	0.935	11.51
4103-0521	0.521	6.11	4103-0604	0.604	6.11	4103-0687	0.687	6.50	4103-0770	0.770	8.81	4103-0853	0.853	10.72	4103-0936	0.936	11.51
4103-0522	0.522	6.11	4103-0605	0.605	6.11	4103-0688	0.688	6.50	4103-0771	0.771	8.81	4103-0854	0.854	10.72	4103-0937	0.937	11.51
4103-0523	0.523	6.11	4103-0606	0.606	6.11	4103-0689	0.689	6.50	4103-0772	0.772	8.81	4103-0855	0.855	10.72	4103-0938	0.938	11.51
4103-0524	0.524	6.11	4103-0607	0.607	6.11	4103-0690	0.690	6.50	4103-0773	0.773	8.81	4103-0856	0.856	10.72	4103-0939	0.939	11.51
4103-0525	0.525	6.11	4103-0608	0.608	6.11	4103-0691	0.691	6.50	4103-0774	0.774	8.81	4103-0857	0.857	10.72	4103-0940	0.940	11.51
4103-0526	0.526	6.11	4103-0609	0.609	6.11	4103-0692	0.692	6.50	4103-0775	0.775	8.81	4103-0858	0.858	10.72	4103-0941	0.941	11.51
4103-0527	0.527	6.11	4103-0610	0.610	6.11	4103-0693	0.693	6.50	4103-0776	0.776	8.81	4103-0859	0.859	10.72	4103-0942	0.942	11.51
4103-0528	0.528	6.11	4103-0611	0.611	6.11	4103-0694	0.694	6.50	4103-0777	0.777	8.81	4103-0860	0.860	10.72	4103-0943	0.943	11.51
4103-0529	0.529	6.11	4103-0612	0.612	6.11	4103-0695	0.695	6.50	4103-0778	0.778	8.81	4103-0861	0.861	10.72	4103-0944	0.944	11.51
4103-0530	0.530	6.11	4103-0613	0.613	6.11	4103-0696	0.696	6.50	4103-0779	0.779	8.81	4103-0862	0.862	10.72	4103-0945	0.945	11.51
4103-0531	0.531	6.11	4103-0614	0.614	6.11	4103-0697	0.697	6.50	4103-0780	0.780	8.81	4103-0863	0.863	10.72	4103-0946	0.946	11.51
4103-0532	0.532	6.11	4103-0615	0.615	6.11	4103-0698	0.698	6.50	4103-0781	0.781	8.81	4103-0864	0.864	10.72	4103-0947	0.947	11.51
4103-0533	0.533	6.11	4103-0616	0.616	6.11	4103-0699	0.699	6.50	4103-0782	0.782	8.81	4103-0865	0.865	10.72	4103-0948	0.948	11.51
4103-0534	0.534	6.11	4103-0617	0.617	6.11	4103-0700	0.700	6.50	4103-0783	0.783	8.81	4103-0866	0.866	10.72	4103-0949	0.949	11.51
4103-0535	0.535	6.11	4103-0618	0.618	6.11	4103-0701	0.701	6.50	4103-0784	0.784	8.81	4103-0867	0.867	10.72	4103-0950	0.950	11.51
4103-0536	0.536	6.11	4103-0619	0.619	6.11	4103-0702	0.702	6.50	4103-0785	0.785	8.81	4103-0868	0.868	10.72	4103-0951	0.951	11.51
4103-0537	0.537	6.11	4103-0620	0.620	6.11	4103-0703	0.703	6.50	4103-0786	0.786	8.81	4103-0869	0.869	10.72	4103-0952	0.952	11.51
4103-0538	0.538	6.11	4103-0621	0.621	6.11	4103-0704	0.704	6.50	4103-0787	0.787	8.81	4103-0870	0.870	10.72	4103-0953	0.953	11.51
4103-0539	0.539	6.11	4103-0622	0.622	6.11	4103-0705	0.705	6.50	4103-0788	0.788	8.81	4103-0871	0.871	10.72	4103-0954	0.954	11.51
4103-0540	0.540	6.11	4103-0623	0.623	6.11	4103-0706	0.706	6.50	4103-0789	0.789	8.81	4103-0872	0.872	10.72	4103-0955	0.955	11.51
4103-0541	0.541	6.11	4103-0624	0.624	6.11	4103-0707	0.707	6.50	4103-0790	0.790	8.81	4103-0873	0.873	10.72	4103-0956	0.956	11.51
4103-0542	0.542	6.11	4103-0625	0.625	6.11	4103-0708	0.708	6.50	4103-0791	0.791	8.81	4103-0874	0.874	10.72	4103-0957	0.957	11.51
4103-0543	0.543	6.11	4103-0626	0.626	6.50	4103-0709	0.709	6.50	4103-0792	0.792	8.81	4103-0875	0.875	10.72	4103-0958	0.958	11.51
4103-0544	0.544	6.11	4103-0627	0.627	6.50	4103-0710	0.710	6.50	4103-0793	0.793	8.81	4103-0876	0.876	10.72	4103-0959	0.959	11.51
4103-0545	0.545	6.11	4103-0628	0.628	6.50	4103-0711	0.711	6.50	4103-0794	0.794	8.81	4103-0877	0.877	10.72	4103-0960	0.960	11.51
4103-0546	0.546	6.11	4103-0629	0.629	6.50	4103-0712	0.712	6.50	4103-0795	0.795	8.81	4103-0878	0.878	10.72	4103-0961	0.961	11.51
4103-0547	0.547	6.11	4103-0630	0.630	6.50	4103-0713	0.713	6.50	4103-0796	0.796	8.81	4103-0879	0.879	10.72	4103-0962	0.962	11.51
4103-0548	0.548	6.11	4103-0631	0.631	6.50	4103-0714	0.714	6.50	4103-0797	0.797	8.81	4103-0880	0.880	10.72	4103-0963	0.963	11.51
4103-0549	0.549	6.11	4103-0632	0.632	6.50	4103-0715	0.715	6.50	4103-0798	0.798	8.81	4103-0881	0.881	10.72	4103-0964	0.964	11.51
4103-0550	0.550	6.11	4103-0633	0.633	6.50	4103-0716	0.716	6.50	4103-0799	0.799	8.81	4103-0882	0.882	10.72	4103-0965	0.965	11.51
4103-0551	0.551	6.11	4103-0634	0.634	6.50	4103-0717	0.717	6.50	4103-0800	0.800	8.81	4103-0883	0.883	10.72	4103-0966	0.966	11.51
4103-0552	0.552	6.11	4103-0635	0.635	6.50	4103-0718	0.718	6.50	4103-0801	0.801	8.81	4103-0884	0.884	10.72	4103-0967	0.967	11.51
4103-0553	0.553	6.11	4103-0636	0.636	6.50	4103-0719	0.719	6.50	4103-0802	0.802	8.81	4103-0885	0.885	10.72	4103-0968	0.968	11.51
4103-0554	0.554	6.11	4103-0637	0.637	6.50	4103-0720	0.720	6.50	4103-0803	0.803	8.81	4103-0886	0.886	10.72	4103-0969	0.969	11.51
4103-0555	0.555	6.11	4103-0638	0.638	6.50	4103-0721	0.721	6.50	4103-0804	0.804	8.81	4103-0887	0.887	10.72	4103-0970	0.970	11.51
4103-0556	0.556	6.11	4103-0639	0.639	6.50	4103-0722	0.722	6.50	4103-0805	0.805	8.81	4103-0888	0.888	10.72	4103-0971	0.971	11.51
4103-0557	0.557	6.11	4103-0640	0.640	6.50	4103-0723	0.723	6.50	4103-0806	0.806	8.81	4103-0889	0.889	10.72	4103-0972	0.972	11.51
4103-0558	0.558	6.11	4103-0641	0.641	6.50	4103-0724	0.724	6.50	4103-0807	0.807	8.81	4103-0890	0.890	10.72	4103-0973	0.973	11.51
4103-0559	0.559	6.11	4103-0642	0.642	6.50	4103-0725	0.725	6.50	4103-0808	0.808	8.81	4103-0891	0.891	10.72	4103-0974	0.974	11.51
4103-0560	0.560	6.11	4103-0643	0.643	6.50	4103-0726	0.726	6.50	4103-0809	0.809	8.81	4103-0892	0.892	10.72	4103-0975	0.975	11.51
4103-0561	0.561	6.11	4103-0644	0.644	6.50	4103-0727	0.727	6.50	4103-0810	0.810	8.81	4103-0893	0.893	10.72	4103-0976	0.976	11.51
4103-0562	0.562	6.11	4103-0645	0.645	6.50	4103-0728	0.728	6.50	4103-0811	0.811	8.81	4103-0894	0.894	10.72	4103-0977	0.977	11.51
4103-0563	0.563	6.11	4103-0646	0.646	6.50	4103-0729	0.729	6.50	4103-0812	0.812	8.81	4103-0895	0.895	10.72	4103-0978	0.978	11.51
4103-0564	0.564	6.11	4103-0647	0.647	6.50	4103-0730	0.730	6.50	4103-0813	0.813	8.81	4103-0896	0.896	10.72	4103-0979	0.979	11.51
4103-0565	0.565	6.11	4103-0648	0.648	6.50	4103-0731	0.731	6.50	4103-0814	0.814	8.81	4103-0897	0.897	10.72	4103-0980	0.980	11.51
4103-0566	0.566	6.11	4103-0649	0.649	6.50	4103-0732	0.732	6.50	4103-0815	0.815	8.81	4103-0898	0.898	10.72</			

MAGNETIC BASES

Pro-Series MAGNETIC BASES

- Overall height: 9" .
- Off and On switch.
- Scribe-opening: 5/32" .
- Power Pull: 130 lbs.
- Base size : 2" (Width) x 2-1/2" (Depth).
- Holds most AGD dial and test indicators.
- V-shape on bottom surface for firm holding.



Standard
4401-1100
\$2694
(F)

With Fine Adjustment
4401-0001
\$2865
(F)

MAGNETIC BASE WITH DOVETAIL CLAMP

- Dovetail groove for clamping a test indicator
- Indicator stem hole on top 8mm diameter
- Fine adjustment
- On/Off magnet switch
- Base dimension: 2x2x2-1/4" (depth)
- Main stem: 7" long
- Branch stem: 8" long
- Magnet power pull: 130lbs



4401-0530
\$3567
(F)

Dasqua® MAGNETIC BASES WITH FINE ADJUSTMENT

- Highest quality craftsmanship.
- V-grooved base for easy and secure mount on cylindrical parts.
- Chrome plated rods.
- Horizontal or vertical positioning capability.
- Blue wrinkled finish on non-working surfaces.
- Fine quality permanent magnet.
- Smooth and easy on/off switch.

4mm, 8mm, 3/8"

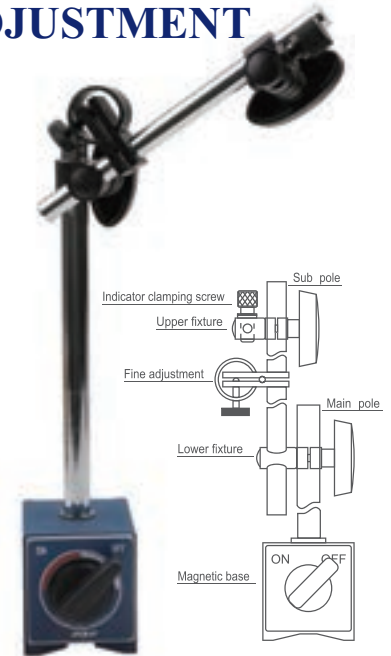

Item#	Holding Power	Base	Main Pole	Sub Pole	Dia. of Clamp Hole	Weight	Fine Adjustment	Price (F)
7122-0004	60kg	60x50x55mm	Ø12x176mm	Ø10x150mm	6.0/8.0mm	1.5kg	With Fine Adjustment	19.95
7123-1004	60kg	60x50x55mm	Ø12x176mm	Ø10x150mm	6.0/8.0mm/3/8"	1.5kg	With Fine Adjustment	25.30

SUPER POWER DIN MAGNETIC BASE

- Power Pull: 160 lbs.
- On/off switch
- Base Dimension: 2.75" (Depth) x 1.77" (Width) x 2.56" (Height)
- Main Stem: 5/8" dia. x 9"
- Extension Stem: 0.47" dia. x 8" with fine adjustment
- Hold any indicators with stem 8mm diameter.



4401-0515
\$5440
(F)

Limited Supply!

DUAL CLAMPING HOLES MAGNETIC BASE-One Knob Lock

- Dual Stem Clamping Hole: 8mm & 3/8"
- Dovetail groove for testing indicator
- Base dimension: 1-1.97(W) x 2.17(H) x 2.36" (D)
- On/Off switch
- Max. Reach: 17"
- 180 lbs. magnet power.

4401-0008
\$6563
(F)

Base (LxWxH)	Tapped Hole	Main Stem	Branch Stem	Weight
60x50x55	M10x1.5	Ø16x230	Ø16x210	1.9kg



MINI UNIVERSAL MAGNETIC BASES

- 3-D rigid steel arm movement.
- Unique central locking mechanism.
- Accepts all A.G.D. dial indicators and test indicators.
- Base Dimension: 1.2" (width) x 1.5" (depth).
- Holds 3/8" stem dial indicators & dovetail test indicators
- On/Off magnet power switch.
- Max. Reach: 7.5" .
- With 8mm bushing

With Fine Adjustment
4401-0811
\$6748
(F)

4401-0810
\$6299
(F)



MINI INDICATOR MAG. BASE-One Knob Lock

- Base dimension: 1-1/8 (W) x 1-3/8 (H) x 1-3/8" (D)
- Max. Reach: 10"
- On/Off switch
- Hold stems: 8mm & 3/8"
- With dovetail clamp

4401-0005
\$3971
(F)

Limited Supply!



MAGNETIC INDICATOR HOLDER

- Holds most of dial and test indicators.
- Stem holds: 3/8" ,5/16" , 1/4" diameter.
- 80 lbs magnetic pull.
- Overall height: 5"
- Fine adjustment.

4401-0004
\$1917
(F)



UNIVERSAL MECHANISM MAGNETIC BASE

- 3-D rigid steel arm movement.
- Unique central locking mechanism.
- Overall stem length: 11.4"
- Fine adjustment.
- On/Off switch.
- Super power pull 130 lbs.
- Base Dimension: 2" (Width) x 2-1/2" (Depth)
- Accepts all AGD dial indicators and test indicators.

4401-0511
\$6989
(F)



HIP
PRO-SERIES

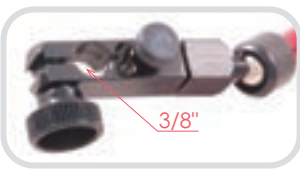

EASY RELEASE MAGNETIC BASE



Limited Supply!

- Single universal rod, has 3 diameters to allow mounting popular indicators without changing rods
- Full 360° swivel
- Strong magnetic pull with easy release switch

4401-0802
\$3478
(F)

HEAVY DUTY UNIVERSAL MAGNETIC BASES



- 3-D rigid aluminum arm movement.
- Unique central locking mechanism.
- Fine adjustment.
- On/Off switch.
- Accepts all AGD dial indicators and test indicators.

Item#	Power Pull (Lbs.)	Base (L x W x H)	Max. Reach (Inch)	Price (F)
4401-0536	132	58x50x55mm	13.0	110.41
4401-0537	176	60x50x55mm	14.5	122.16
4401-0538	220	74x50x55mm	16.0	142.23

UNIVERSAL MAGNETIC BASE -UNIQUE TOP ADJUSTMENT



- 3-D rigid aluminum arm movement.
- Unique fine adjustment mechanism.
- On/Off switch
- Dovetail groove for test indicator



Item#	Power Pull (Lbs.)	Base (L x W x H)	Max. Reach (Inch)	Price (F)
4401-0532	66	36x30x35mm	6.5	79.26
4401-0533	176	60x50x55mm	10.7	106.95
4401-0534	220	74x50x55mm	13.7	107.22

MAGNETIC BASES

Dasqua® LOCK'T MAGNETIC BASE

- All wear parts use hardened high grade steel and with hardness over HRC 58°.
- Inner structure is made of bearing steel, delivering more wear-resisting ability and longer service life.

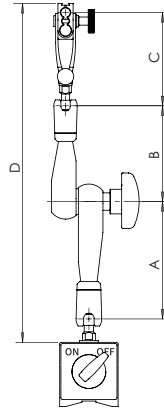

Item#	Power Pull	Base Dimensions	Thread Mount	(mm)			Reach Length (D)	Price (F)
				A	B	C		
7121-0020	50kg	40x40x40	M6x1.00	62	52	79	220	94.72
7121-0025	80kg	60x50x55	M8x1.25	100	82	81	290	102.23
7121-0030	100kg	74x50x55	M8x1.25	145	95	81	355	119.55

- 6mm, 8mm, 3/8"**
- Three clamping holes**
Designed with three clamping holes, which are suitable for metric and inch dual indicators, plus dovetail groove for test indicators, bringing great convenience & holding capabilities.
- Ergonomic design**
Ergonomic designed lightweight knob provides comfortable and firm grip. Flexible and super strong rotary joints, produce smooth adjustments in any direction or location.
- Super force locking mechanical universal arm**
New type locking mechanism, super strong arm lock and super tight locking force guarantees long life and firm positioning.
- CNC Machining**
Main parts produced on CNC machines, providing extremely accurate and high-precision fit. Ensuring high-quality and high stability.

PRECISION MEASURING TOOLS

STRONG-LOCK UNIVERSAL MAGNETIC BASE



4401-0528
\$125⁴⁰

- Solid arm & Joint mechanism.
- Unique central locking mechanism.
- 3-D steel arm movement.
- Overall stem length 18"
- Fine adjustment.
- On/Off switch.
- Super power pull 220 lbs.
- Base Dimension: 2 x 2 x 3" (Depth)
- Our most rigid system.

HYDRAULIC MAGNETIC BASE

- Absolute sealed hydraulic system.
- Knob turning creates tension and high pressure on the joints to hold the rods absolutely rigid.
- Multi-nimble joint for instant fix at any desired position.
- Fine adjustment.
- Fits dovetail and 3/8" stem indicators.
- Super power pull 130 lbs.
- Overall stem length 13"
- Base Dimension: 2" (Width) x 2-1/2" (Depth)

4401-0003
\$110¹⁷

GRANITE STAND W/UNIVERSAL ARM

- 12x8x2" granite plate.
- 3-D rigid steel arm movement.
- Unique central locking mechanism.
- Fine adjustment.
- Dovetail groove for clamping test indicator
- Indicator stem hole 8mm
- Overall Reach: 15"
- Weight: 24 lbs.

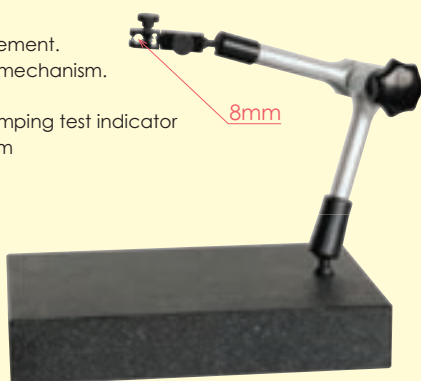

4401-0120
\$191⁴⁸

ROUND UNIVERSAL MAGNETIC BASE

- 3-D rigid steel arm movement.
- Overall stem length 10"
- Hold 3/8" stem indicator or dovetail.
- Unique central locking mechanism.
- Fine adjustment.
- Power pull 90 lbs.
- Base Diameter: 1.6"

4401-0525
\$91⁶⁹

Group 2 INDICATOR MAGNETIC BACKS

- Diameter of Magnetic Back: 2-1/4" for Group II indicators.
- Magnetic back comes with screw-on indicator plain back.
- Can be used with both lug back and plain back indicators.
- Permanent magnet with strong power pull.



4401-0055
\$756
(F)

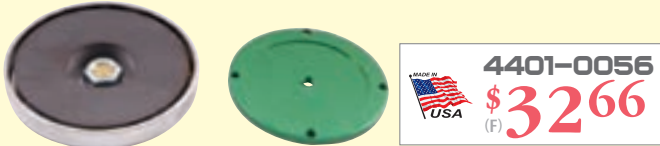

MADE IN USA
4401-0056
\$3266
(F)

CENTERED V-MAGNETS

- Grip on round or flat surfaces
- Post Mount Thread: M8x1.25
- 2 magnetic mounting surfaces-bottom and back
- On/off switch



* Post Mount Thread: M5x0.8

Item#	Dimensions	Power Pull	Price (F)
4401-0814*	1.4 x 1.2 x 1.5"	66 lbs.	24.95
4401-0111	2 x 2 x 2-1/2"	170 lbs.	18.75
4401-0108	2 x 2 x 4-5/8"	260 lbs.	59.36

MITY-MAG INDICATOR HOLDER

- Zinc die cast housing.
- 45 lbs holding power.
- Hold up to 3/8" dia. stem.
- 5 Locations for mounting accessories.
- Holder Dimensions: 4-1/2" x 1" x 1-1/4".

4401-0042
\$978
(G)

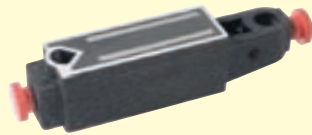

FLEXIBLE ARM MAGNETIC BASE

- Permanent magnet with On/Off switch control.
- Cam lever operates cable. Locks if rigid at any desired position.
- Cable tension adjustable.
- Stem flexes full 360°.
- Accepts all A.G.D. dial indicators.
- Overall length: 13"
- Power Pull: 130 lbs.
- Base Dimension: 2" (Width) x 2-1/2" (Depth)

4401-0002
\$5190
(F)



Pro-Series CONTOUR MAGNETIC BASE

- Cam lock mechanism
- Unlimited versatility
- Fine Adjustment
- On/Off knob



4401-0510
\$5571
(F)

LOCKING PLIER SHAFT INDICATOR HOLDER

- Accept AGD group indicators
- Vise-Grip easy to hold the indicator anywhere.
- Flexible shaft made from steel
- 13" reach



4401-0520
\$4510
(F)

Limited Supply!

Dasqua® DISC AND ROTOR FLEX CHROME AUTOMOTIVE SET

- Checks ball joint wear, disc rotor runout, tire and whirrl runout, gear backlash, valve, guide, etc.

Includes:

- Dial Indicator: 0-1", .001" Graduation (item# 5122-4210)
- Flexible Chrome Shank Magnetic Base (item# 7611-0035)
- Fitted Case

7611-0025
\$10988
(F)



INDICATOR STANDS

Dasqua® UNIVERSAL PRECISION GRANITE STANDS

- Precise ground granite base.
- Extremely rugged and universally adjustable to any position, these gage stands are well suited for inspection and layout.
- Checking and lineup operations anywhere in the shop.

- All settings are individually made without disturbing others.
- These versatile stands allow the indicator to be positioned at any height within the capacity of the upright base post.
- 360° both horizontally and vertically.
- Strictly made in accordance with DIN876.



DIN 876

Includes:
Clamps: 6mm/8mm with fine adjustment and dovetail clamp



Item#	Base Dimension	Post height	Post reach	Flatness	Price (F)
7812-0005	6x4"	Ø14x200mm	Ø12x165mm	0.002mm	190.97
7812-0010	10x5.5"	Ø14x200mm	Ø12x165mm	0.002mm	218.27

16" GRANITE CHECK REPLACEMENT COLUMN-Post

Optional Long Column for Holding Long Range Indicators

PRICE IS FOR POST ONLY

4401-0018
\$4623

Includes Clamp & Mounting Screw

INDICATOR & GRANITE PLATE NOT INCLUDED

- Convert your standard 6x6, 6x8 or 12x8 base to larger capacity stand with this 1" diameter column.
- 16" column includes mounting screw and fine adjustment clamp for all AGD indicators with lug back.

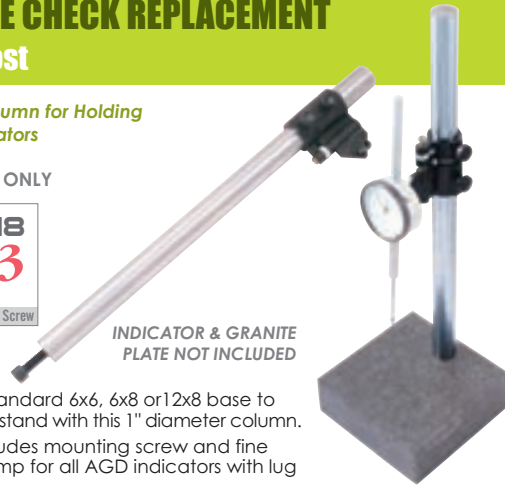

GRANITE CHECK - INDICATOR STAND

- Fine adjustment.
- 10" height.
- 0.00005" granite flatness.
- Accepts all AGD Indicators with lug back.

Stand & 1" Travel Indicator Kit
4401-2001
\$8357

4401-0020 & 4400-0001

Granite Stand Only

Item#	Base Size	Price (G)
4401-0020	6 x 6 x 2"	67.07
4401-0021	6 x 8 x 2"	84.19
4401-0019	12 x 8 x 2"	126.82



UNIVERSAL INDICATOR STAND WITH V SHAPE BASE

- Heavy base with V-shape base.
- Base is made of high grade tool steel hardened and precision ground.
- Universal mechanism arm with fine adjustment.
- Conforms to most AGD indicators.
- Weight: 6.80 lbs

NEW

4401-0125
\$16981

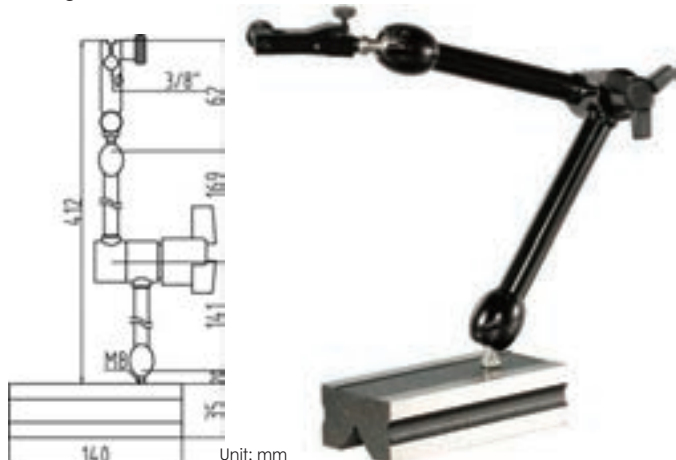

UNIVERSAL MEASURING STAND

- Heavy base allows any surface set-up.
- Base is made of high grade tool steel hardened and precision ground.
- With fine adjustment.
- Max. Extension: 14"
- Base Dimension: 8.90" Length x 2.30" Width x 1.40" Height.
- Conforms to most of AGD indicators.
- Weight: 7 lbs

4401-0413
\$6474



INDICATOR STAND WITH V SHAPE BASE

- Heavy base with V-shape base.
- Base is made of high grade tool steel hardened and precision ground.
- With fine adjustment.
- Conforms to most AGD indicators.
- Weight: 6 lbs

NEW

4401-0130
\$11635

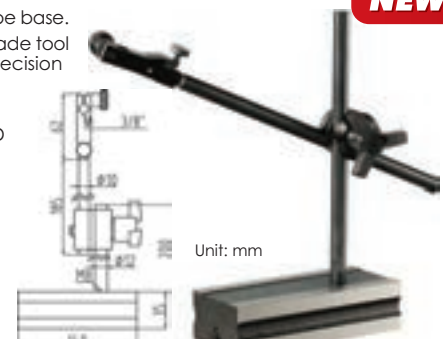

INDICATOR & MAGNETIC BASE KITS

2PC MAGNETIC BASE & INDICATOR KIT

PRO-SERIES MAGNETIC BASES

- Overall height: 9" .
- Off and On switch.
- Scribe-opening: 5/32" .
- Power Pull: 130 lbs.
- Base size : 2" (Width) x 2-1/2" (Depth).
- Holds most of AGD dial and test indicators.

0-1" DIAL INDICATOR

- Graduation: .001"
- Stem: 3/8" diameter.
- 2" Dia. dial face.
- Lug back.

4401-0017
\$4140
(F)
4401-1100 & 4400-0001



2PC MAGNETIC BASE & INDICATOR KIT

0-1" DIAL INDICATOR

- Graduation: .001"
- Lug back
- Contact point thread 4-48
- Stem: 3/8"
- Dial Face: 2"

4401-0015
\$5225
(F)
Complete with fitted case

MAGNETIC BASE

- Fine adjustment,
- On/off switch,
- Power Pull: 130 lbs.
- Overall Height: 9"
- Max Reach: 16"
- Hold most of AGD group indicators
- Base: 2" (Width) x 2-1/2" (Depth)



3PC MAGNETIC BASE & INDICATOR KIT

22PC INDICATOR POINT KIT

- Fits most American and imported indicators.
- A.G.D. specifications (4-48 Threads)
- Assorted points.

0-1" DIAL INDICATOR

- Graduation: .001"
- Stem: 3/8" diameter.
- 2" Dia. dial face.
- Lug back.

MAGNETIC BASE

- Overall height: 9" .
- Off and On switch.
- Scribe-opening: 5/32" .
- Power Pull: 130 lbs.
- Base size : 2" (Width) x 2-1/2" (Depth).
- Holds most of AGD dial and test indicators.

4902-0012
\$5200
(F)
Complete with fitted case



1" DIAL INDICATOR & MAGNETIC BACK KIT

0-1" DIAL INDICATOR

- Graduation: .001"
- Contact point interchangeable with thread 4-48.
- Rack & contact point made of hardened stainless steel.
- Stem: 3/8" diameter.
- Jeweled movement.
- 2" Dia. dial face.

4400-0025
\$3230
(F)



MAGNETIC BACK

- Magnetic back is already mounted on indicator.
- Magnetic back comes with screw on/off back.
- Magnetic back has protective coating and is used to position indicator of most metal surfaces.
- Magnetic back diameter: 2-1/4"

MITY-MAG HOLDER & 1" TRAVEL DIAL INDICATOR KIT

0-1" DIAL INDICATOR

- Graduation: .001"
- Contact point interchangeable with thread 4-48.
- Rack & contact point made of hardened stainless steel.
- Stem: 3/8" diameter.
- Jeweled movement.
- 2" Dia. dial face.
- Lug back.

4400-0024
\$2625
(E)
4400-0001 & 4401-0042



MITY-MAG HOLDER

- Zinc die cast housing.
- 45 lbs holding power.
- 5 Locations for mounting accessories.
- Hold up to 3/8" dia. stem.
- Holder Dimension: 4-1/2 x1x1-1/4"

3PC DIAL INDICATOR, MITY-MAG HOLDER & 22PC IND. POINT KIT

22PC INDICATOR POINT KIT

- Fits most American and imported indicators.
- A.G.D. Specifications (4-48 Threads).
- Assorted points.

0-1" DIAL INDICATOR

- Graduation: .001"
- Contact point interchangeable with thread 4-48.
- Rack & contact point made of hardened stainless steel.
- Stem: 3/8" diameter.
- Jeweled movement.
- 2" Dia. dial face.
- Lug back.

4400-0026
\$3325
(F)

MITY-MAG HOLDER

- Zinc die cast housing.
- 45 lbs holding power.
- 5 Locations for mounting accessories.
- Hold up to 3/8" dia. stem.
- Holder Dimension: 4-1/2 x1x1-1/4"

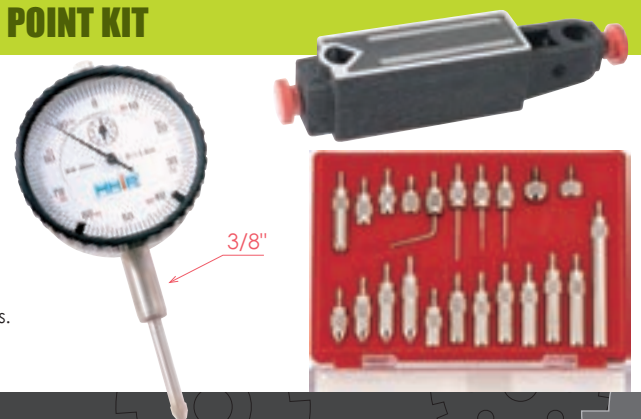

INDICATOR & MAGNETIC BASE KITS

DIAL TEST INDICATOR & MINI UNIVERSAL MAGNETIC BASE KIT

4400-0016
\$108⁰⁰
 (E)

4400-0010 & 4401-0810

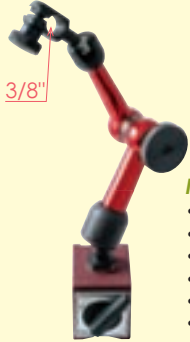

0-0.03" RANGE TEST INDICATOR

- Graduation: .0005"
- Reading: 0-15-0
- Precision pivot bearing.
- 0.098" Contact point.
- Satin chrome finish.
- Dovetail mount top, back, & front.
- Includes fitted case & 2 stems (5/32" & 3/8").
- Jeweled movements.
- Automatic reversing.



MINI UNIVERSAL MAG BASE

- 3-D rigid steel arm movement.
- Unique central locking mechanism.
- Accepts all A.G.D. dial indicators and test indicators.
- On/Off magnet power switch.
- Max. Reach: 7.5".
- Base Dimension: 1.2" (width) x 1.5" (depth).

DIAL TEST INDICATOR & MINI UNIVERSAL MAGNETIC BASE KIT

0-0.03" RANGE TEST INDICATOR

- Graduation: .0005"
- Dovetail mount top, back, & front.
- Includes fitted case & 2 stems (5/32" & 3/8").
- Precision pivot bearing.
- Reading: 0-15-0
- 0.098" Contact point.
- Satin chrome finish.
- Jeweled movements.
- Automatic reversing.

4400-0027
\$124²⁰
 (E)

4400-0010 & 4401-0811



MINI UNIVERSAL MAG BASE WITH FINE ADJUSTMENT

- 3-D rigid steel arm movement.
- Unique central locking mechanism.
- Accepts all A.G.D. dial indicators and test indicators.
- On/Off magnet power switch.
- Max. Reach: 7.5".
- Base Dimension: 1.2" (width) x 1.5" (depth).

3PC TEST INDICATOR, TRAVEL INDICATOR & UNIVERSAL MAGNETIC BASE KIT

0-0.03" RANGE TEST INDICATOR

- Dovetail mount top, back, & front.
- Includes fitted case & 2 stems (5/32" & 3/8").
- Reading: 0-15-0
- Graduation: .0005"
- Precision pivot bearing.
- 0.098" Contact point.
- Satin chrome finish.
- Jeweled movements.
- Automatic reversing.

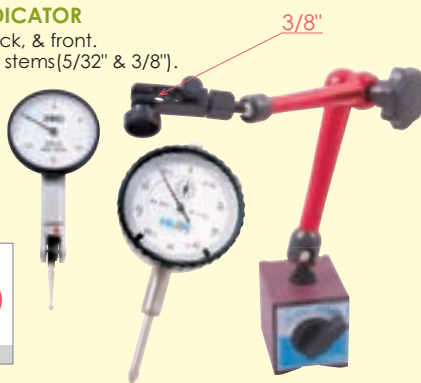

4400-0018
\$137⁰⁰
 (E)

4400-0010, 4400-0001 & 4401-0511

0-1" DIAL INDICATOR

- Graduation: .001"
- Contact point interchangeable with thread 4-48.
- Stem: 3/8" diameter.
- Rack & contact point made of hardened stainless steel.
- Jeweled movement.
- 2" Dia. dial face.
- Lug back.

PRO-QUALITY UNIVERSAL MAGNETIC BASE

- 3-D rigid steel arm movement.
- Unique central locking mechanism.
- Fine adjustable.
- On/Off switch.
- Super power pull 130 lbs.
- Base Dimension: 2"(Width)x2-1/2"(Depth)

Interapid STYLE TEST INDICATOR & MAGNETIC INDICATOR HOLDER KIT

0-0.060" TEST INDICATOR

- Swiss type horizontal dial test indicator
- .080" tungsten carbide point
- Automatic reversal
- Jeweled movement
- Dial reading 0-15-0
- Easy-to-read tilted dial

- Dial diameter: 1-1/2"
- 210° swivel arc.
- Graduation: .0005"



4400-0023
\$132³⁰
 (E)

4400-1006 & 4401-0004

INDICATOR HOLDER

- 80 lbs magnetic pull.
- Overall height: 5"
- Fine adjustment.
- Holds most dial and test indicators.
- Stem holds: 3/8, 5/16, 1/4" diameter.

Dasqua® 7PC ULTRA PRECISION MACHINIST SET

SET INCLUDES:

- 176lbs. super strong power pull 275mm arm length magnetic base with fine adjustment (7121-0025)
- Big screen IP67 oil proof digital caliper, 0-150mm/0-6" range, 0.0005" resolution, inch/metric/fraction (2015-2405)
- 0-150mm/0-6" rule, graduations: 0.5, 1.0, 1/64", 1/32", 1/16" (1012-2011)
- IP65 digital outside micrometer, 0-25mm/0-1" range, 0.0005" resolution (4410-1105)
- Dial test indicator with shock proof gearing, 0-0.8mm range, 0.001" resolution (5211-1129)
- Ultra precision 1-2-3 blocks, squareness 0.0001"/1" (8407-0005)
- Depth base attachment (3001-1001)
- Aluminum case.

7PC Set
 2210-8250
\$442⁸⁰
 (F)

Complete with fitted case

A MUST FOR EVERY MACHINIST!

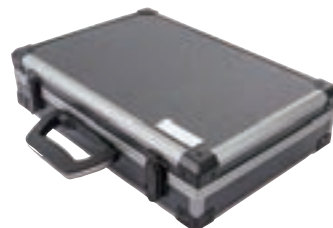

IP67
 COOLANT & FLUID
 RESISTANT

22PC INDICATOR POINT KITS

- Fits most American and imported indicators.
- A.G.D. Specifications (4-48 Threads).
- Assorted points.



4400-0050
 (F) **\$994**

4400-1050
 (F) **\$3620**

BACK PLUNGE DIAL INDICATOR

- Easy to read from top.
- Reading: 0-100
- Conforms to AGD standards.
- Dial face diameter: 1-3/8"
- Made of stainless steel.
- Rotatable bezel.



0-0.20" Range
4400-0015
 (F) **\$5126**

.001" GRADUATION

22PC INDICATOR CONTACT POINT RING & KIT

- 22 Points with 4-48 screw thread to fit AGD indicators
- All Points are mounted on a convenient aluminum ring for safe keeping and ready selection.
- Premium quality.

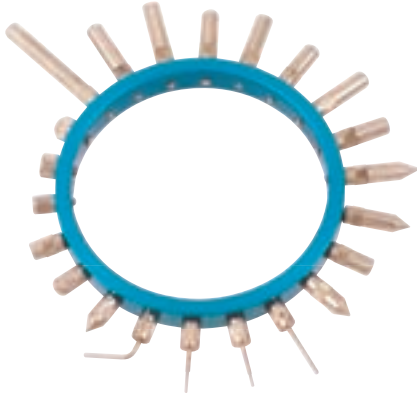

RING ONLY
4401-0480
 (F) **\$943**

22PC POINT & RING KIT
4401-0481
 (F) **\$1727**

0.2" SHORT RANGE DIAL INDICATOR -Designed for Making Comparative Tests

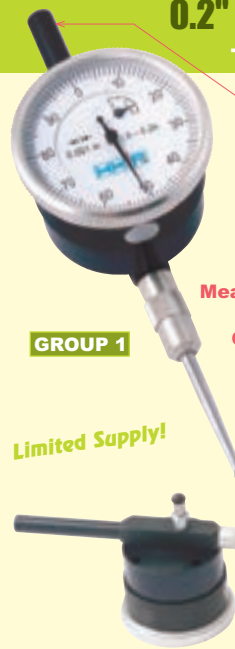

- Dial face: 1-1/2" diameter
- Contact point: .098"x1.25"
- Stem: 1/4"x1.5"
- Includes: 3 plunge contacts: 3/16x3/32", 5/16x3/32" & 3/16x1" & 3/8" bottom contact point.
- Completed with case.

Measuring Range: 0-0.2"
0-100 Reading
Graduation: 0.001"

4400-0031
 (F) **\$6098**

GROUP 1

Limited Supply!



INDICATOR EXTENSION POINTS & KIT

- 4-48 internal and external threads
- Fits most of AGD group indicators



3PC Steel Kit
4401-0433
 (F) **\$1464**

Includes: 1, 2 & 3"

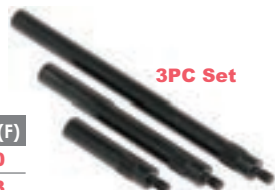

3PC Set

Item#	Length	Material	Price (F)
4401-0439	1"	Stainless Steel	4.80
4401-0441	2"	Stainless Steel	5.43

INDICATOR REPLACEMENT POINT -Inch

- 4-48 threaded contact point for indicators
- Replacement contact point.
- Fits indicators that have a 4-48 thread.
- Made of hardened stainless steel.

4400-3139
 (F) **\$149**



METRIC TO ENGLISH INDICATOR CONVERSION POINT

- Use the same standard inch AGD points with metric indicators
- Dimension: 7/32" dia., 1/2" long
- **4-48 internal threads, M2.5 x 0.45 external threads**
- Steel, black oxide plated



4401-0430
 (F) **\$721**



USE ENGLISH POINTS ON METRIC INDICATORS

Dasqua® INDICATOR REPLACEMENT POINT WITH CARBIDE BALL POINT-Metric

NEW

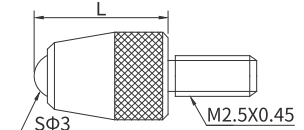

- M2.5 thread.
- Carbide ball point.
- Fits indicators that have a M2.5x0.45 thread.
- Overall length: 7.3mm

Item#	Material	Length	S Ø D	Price (F)
5333-6101	Carbide	7mm	3.0mm	8.45

DIAL INDICATORS

0~.125 TRAVEL DIAL INDICATOR-GROUP 1



- 1-1/2" diameter dial face.
- Reading: 0-50
- Rack & contact point made of hardened stainless steel.
- Jeweled movement.
- Lug back.

AGD GROUP 1

4400-0005
\$25⁶³
(F)

.0005" GRADUATION

DIAL INDICATOR GROUP SPECIFICATIONS

Face Diameter Shown

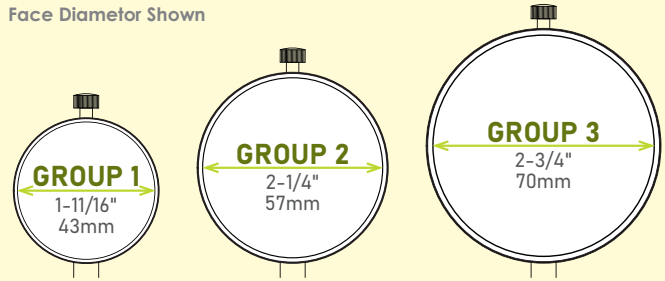

Z-Limit 1/4" TRAVEL DIAL INDICATOR-GROUP 1

- Manufactured and inspected at world class factory that produces highest quality European brands.
- Reading range pointers installed in the bezel.
- Complete with a fitted durable ABS case.
- Long form of Calibration Certificate included.
- 6 Jewel movement.
- Flat back.

.001" GRADUATION
0-100-0 READING

AGD GROUP 1

RANGE: 0~0.25"
4409-1105
\$45⁰²
(F)



SHOCK-PROOF



0~.250 TRAVEL DIAL INDICATOR-GROUP 1

- AGD Group I.
- 1-1/2" diameter dial face.
- Reading: 0-100
- Rack & contact point made of hardened stainless steel.
- Jeweled movement.
- Lug back.

AGD GROUP 1

0~0.25" Range
4400-0003
\$23⁴⁸
(F)

.001" GRADUATION



Dasqua® 0-5mm MINI METRIC DIAL INDICATOR -GROUP 1



- With calibration certificate.
- Used to measure surface flatness as well as axial runout and also used to check tool set up and squareness.
- Limit indicator clips included.
- Strictly made in accordance with DIN878.
- Jeweled bearings providing the lowest possible bearing friction.
- With narrowed range and higher accuracy.
- Flat back.



AGD GROUP 1

0~0.5mm Range
5121-1102
\$51⁵³
(F)

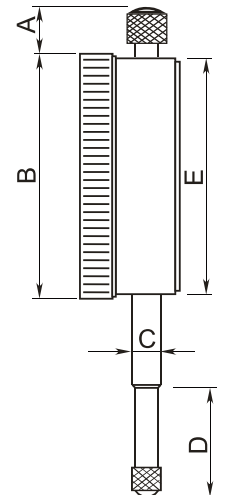

Range	Graduation	(mm)					Accuracy	Hysteresis
		A	B	C	D	E		
0-5	0.01	6.5	Ø40	Ø8	12.5	Ø36	0.014	0.003

0-0.4" WATERPROOF DIAL INDICATOR -GROUP 2

- Robust, shockproof design
- Travel: 0-0.4"
- Readig: .001"
- Continuous reading: 0-50
- Tolerance markers
- AGD Group 2, 2-1/4" dia.
- Stem: 8mm
- Lug back and carbide contact point.



Limited Supply!

.0005 GRADUATION

WATERPROOF

RANGE: 0~0.4"
4400-1280
\$4235
 (F)

Protection Includes:

- Rubber bellows on stem
- Sealed back plate
- O-ring seal on safety cap
- O-ring protection for bezel and rotating dial

AGD GROUP 2

DIAL INDICATORS -GROUP 2

- Rack & contact point made of hardened stainless steel.
- Contact point interchangeable with thread 4-48.
- Stem: 3/8" diameter.
- Jeweled movement.
- 2" Dia. dial face.
- Lug Back

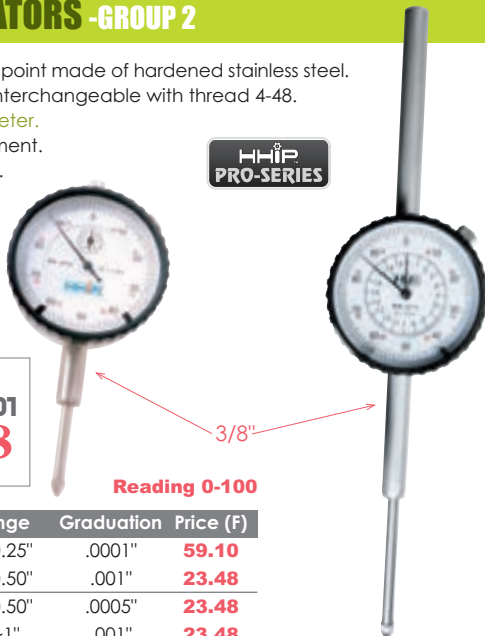

HIP PRO-SERIES

AGD GROUP 2

0~1" Range
4400-0001
\$2348
 (F)

Reading 0-100

Item#	Range	Graduation	Price (F)
4400-1250	0~0.25"	.0001"	59.10
4400-0004	0~0.50"	.001"	23.48
4400-1095	0~0.50"	.0005"	23.48
4400-0001	0~1"	.001"	23.48
4400-1100	0~1"	.0005"	23.48
4400-1000	0~1"	.0001"	72.02
4400-0012	0~1" (Flat Back)	.001"	21.97
4400-0002	0~2"	.001"	48.91

0~2" Range
4400-0002
\$4891
 (F)

Replacement Contact Point (4-48 thread)(Item #4400-3139).....\$1.49(F)

Pro-Series COLOR FACE DIAL INDICATORS -GROUP 2

- Contact point interchangeable with thread 4-48.
- Rack & contact point made of hardened stainless steel.
- Jeweled movement.
- Stem: 3/8" diameter.
- 2" Dia. dial face.
- Graduation: 0.001"
- Reading: 0-100
- Lug back.

AGD GROUP 2



Blue Face
0~1" Range
4400-1104
\$2348
 (F)

Black Face
0~1" Range
4400-1102
\$2348
 (F)

Black Face
0~2" Range
4400-0035
\$4891
 (F)

Replacement Contact Point (4-48 thread)(Item #4400-3139).....\$1.49(F)

1" DIAL INDICATOR WITH LIFTING LEVER -GROUP 2

- Lifting lever.
- Rack & contact point made of hardened stainless steel.
- Contact point interchangeable with thread 4-48.
- Stem: 3/8" diameter.
- Jeweled movement.
- 2" Dia. dial face.
- Lug Back

AGD GROUP 2

0~1" Range
4400-1090
\$2626
 (F)

Reading 0-100



REPLACEMENT INDICATOR FOR DIAL BORE GAGE SET -GROUP 2

0.0005" GRADUATION
FIT MOST DIAL BORE GAGES

AGD GROUP 2



0~1/4" Range
4400-1252
\$2197
 (F)

DIAL INDICATOR BACK COVER

- For AGD group 2 indicator with 2-1/4" diameter.
- Four hole pattern.



Lug Back
4401-0057
\$364
 (F)



Flat Back
4400-3140
\$364
 (F)

DIAL INDICATORS

Z-Limit 1" TRAVEL INDICATOR-GROUP 2



3/8"

GROUP 2

- 6 Jeweles movement.
- Bezel lock screw designed for easy adjustment.
- Contact point interchangeable with thread 4-48.
- Stem: 3/8" diameter.
- Dial Face: 2.19" diameter.
- Reading range pointers installed in the bezel.
- Long form of calibration certificate included
- Dual Back: flat back installed with an extra lug back.
- Complete with a fitted durable plastic case.

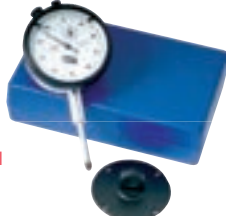

0~1" Range
4409-4001
\$4500
(F)

.001" GRADUATION
READING 0-100-0

Replacement Contact Point (4-48 thread) (Item #4400-3139).....\$1.49(F)

Teclock DIAL INDICATORS-GROUP 2

- Easy-to-read graduations.
- Hard satin-chrome finish.
- Spindle rack, pinions and gear trains are superior quality, ensuring longevity.
- Conforms to AGD specifications.
- Meets or exceeds applicable federal specifications.
- Revolution counter.
- Stem: 3/8" Diameter.
- Face Diameter: 2-3/16".
- 0-100 reading.
- Lug back.

.001" GRADUATION

GROUP 2

0~2" Range
4409-1002
\$15327
(B)



3/8"

0~1" Range
4409-1001
\$6375
(B)

Z-Limit 1" TRAVEL INDICATOR-GROUP 2

- Manufactured and inspected at world class factory that produces highest quality European brands.
- Reading range pointers installed in the bezel.
- Complete with a fitted durable ABS case.
- Long form of Calibration Certificate included.
- Contact point interchangeable with thread 4-48
- AGD Group 2.
- 6 Jewel movement.
- Shock-Proof.
- Stem: 3/8" diameter.
- Reading: 0-100-0.
- Flat back.

SHOCK-PROOF

.001" GRADUATION

GROUP 2



Limited Supply!

0 ~ 1" Range
4409-1101
\$4286
(F)



3/8"

Dasqua® DIAL INDICATORS-GROUP 2

- Used to measure surface flatness as well as axial runout and also used to check tool set up and squareness.
- Limit indicator clips included.
- Strictly made in accordance with DIN878.
- Jeweled bearings on 5122-4215 and 5122-4220 provide the lowest possible bearing friction.
- Casting diameter: 58mm, shank diameter: 8mm
- Satin chrome plated steel case.

GROUP 2

.001" GRADUATION

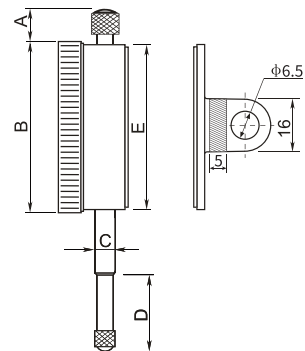

Replacement M2.5 x 0.45mm Point (Item #5260-9999).....\$1.75(F)

Item#	Range	Scale divisions	Style	(mm)					Accuracy	Protection Standard	Price (F)
				A	B	C	D	E			
5122-4210	0-1"	0.001"	lug back	8.5	58	8	40.9	53.5	0.002"	No Jeweled Bearing	32.14
5122-4220	0-1"	0.001"	lug back	8.5	58	8	40.9	53.5	0.002"	Jeweled Bearing	62.01
5122-4214	0-2"	0.001"	lug back	79.3	58	8	57.7	53.5	0.004"	No Jeweled Bearing	52.10
5122-4215	0-2"	0.001"	lug back	79.3	58	8	57.7	53.5	0.004"	Jeweled Bearing	79.74

2" TRAVEL LARGE FACE INDICATOR -GROUP 3

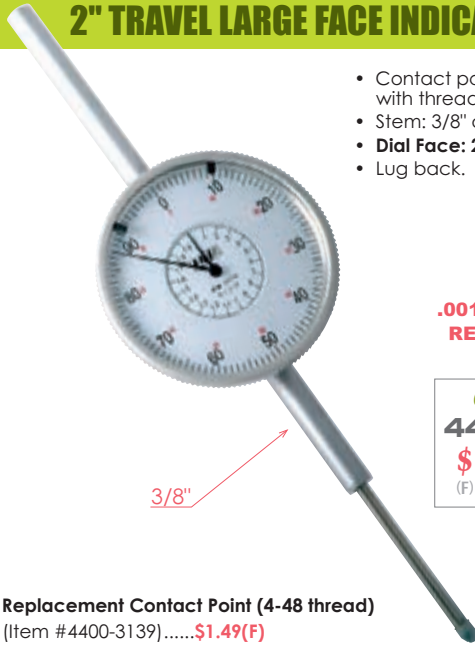

- Contact point interchangeable with thread 4-48.
- Stem: 3/8" diameter.
- **Dial Face: 2.97" diameter.**
- Lug back.

GROUP 3

**.001" GRADUATION
READING 0-100-0**

**0~2" Range
4400-0036
\$5322 (F)**

Replacement Contact Point (4-48 thread)
(Item #4400-3139).....\$1.49(F)

Dasqua® DIAL INDICATOR WITH MAGNETIC BACK -GROUP 2

- Indicator strictly made in accordance with DIN 878.
- Permanent powerful magnet.
- Fitting for all group 2 dial indicator.
- Magnet screws off.
- Magnetic force: 20KG.
- Fitted case.

**Magnetic Back Only
5111-1010
\$985 (F)**

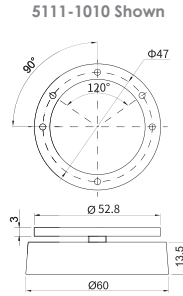

GROUP 2

Magnetic Back with Indicator Kits

Item#	Indicator Included	Indicator Range	Graduation	Stem Dia.	Price (F)
5111-0001	5111-0000	0-10mm	0.01mm	8mm	50.39
5122-4211	5111-4210	0-1"	0.001"	3/8"	44.14

Z-Limit 10MM TRAVEL INDICATOR-GROUP 2

- Manufactured and inspected at world class factory that produces highest quality European brands.
- Contact point interchangeable with thread M2.5
- Complete with a fitted durable ABS case.
- Reading range pointers installed in the bezel.
- Long form of Calibration Certificate included.
- AGD Group 2: 60mm diameter face.
- 6 Jewel movement.
- Shock-Proof.
- Stem: 8mm diameter.
- Flat back.



SHOCK-PROOF

GROUP 2

**.01mm GRADUATION
0-100-0 READING**

Limited Supply!

**0~10MM RANGE
4409-1111
\$4321 (F)**



8mm

METRIC DIAL INDICATORS -GROUP 2

- Reading: 0-100
- Rack & contact point made of hardened stainless steel.
- Jeweled movement.
- 2" diameter dial face.
- Stem: 8mm
- Lug back.

GROUP 2



.01mm GRADUATION

* Limited Supply

Item#	Range	Price (F)
4400-1110*	0~5mm	33.18
4400-1101	0~10mm	25.38
4400-0019	0~20mm	54.91

Teclock METRIC DIAL INDICATORS-GROUP 2

- Easy-to-read graduations.
- Hard satin-chrome finish.
- Spindle rack, pinions and gear trains are superior quality, ensuring longevity.
- Conforms to AGD specifications.
- Meets or exceeds applicable federal specifications.
- Stem: 8mm
- Revolution counter.
- Lug back.

Limited Supply!

.01mm GRADUATION



8mm

GROUP 2

Item#	Range	Price (E)
4409-1112	0~10mm	27.46
4409-1114	0~20mm	47.74
4409-1115	0~30mm	50.76

QUICK ACTION DIGITAL ELECTRONIC INDICATORS-GROUP 2

- Excellent repeatability with quick movement of measurements
- True Inch/MM conversion
- Absolute zero reset button
- On/Off button
- Stem: 8mm
- Lug back
- With fitted case

GROUP 2

**INCH/METRIC
.0005"/.01mm
RESOLUTION**

**0~0.5"/0~12mm
4400-0109
\$5438 (F)**

**0~1"/0~25mm
4400-0110
\$6369 (F)**



8mm

Limited Supply!

DIAL INDICATORS

Dasqua® 0-10MM METRIC DIAL INDICATOR -GROUP 2

DIN 878

- Measuring range 0-10mm
- Graduation is 0.01mm
- Reading is 0-100-0
- Accuracy is 0.017mm
- Hysteresis is 0.003mm
- Scale divisions are 0.01mm
- Strictly made in accordance with DIN 878
- Body diameter is 58mm, shank diameter is 8mm.

GROUP 2

0~10MM Range
5111-1005
\$3578
(F)

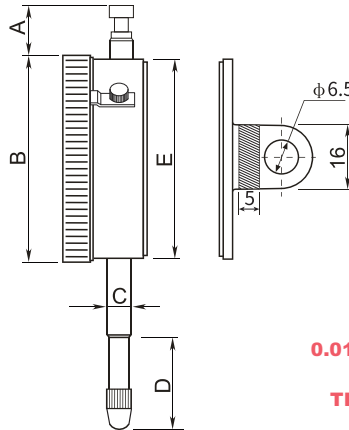

0.01mm GRADUATION

TIP THREAD: M2.5

Specification

Range	Graduation	Style	(mm)					Accuracy	Hysteresis
			A	B	C	D	E		
0-10	0.01	Lug back & Flat back	10.5	58	8	20.5	53.5	0.017	0.003

Dasqua® METRIC DIAL INDICATOR-JEWELLED -GROUP 2

DIN 878

- Used to measure surface flatness as well as axial runout and also used to check tool set up and squareness.
- Limit indicator clips included.
- Strictly made in accordance with DIN 878.
- Jeweled bearing providing the lowest possible bearing friction.
- With narrowed range and higher accuracy.
- Calibration certificate
- Fitted case

0~10MM Range
5111-1205
\$4618
(F)

Flat Back Installed & Lug Back Included



GROUP 2

SHOCK-PROOF



• Internal gears, teeth, clamps, etc. are all plated.



• Strictly made in accordance with DIN 878;



• Poles are precisely grinded, which guarantees concentricity.

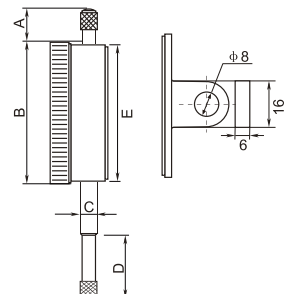

Specifications

Range	Graduation	(mm)					Accuracy	Hysteresis
		A	B	C	D	E		
0-10	0.01	6	Ø58	Ø8	18.5	Ø55	0.017	0.003

Dasqua® DIGITAL ELECTRONIC INDICATORS -GROUP 2



- Calibration certificate provided with total forward error, hysteresis error, total error and deviation error on it.
- Watchcase made of high-strength aluminum alloy guaranteeing low deformation.
- Glass grating for high accuracy and stable performance.
- Temperature and humidity test for each product, ensuring the normal use of each in harsh environment.
- Copper sleeve and rod precisely ground to reduce shaking.
- The functions of tolerance set and tolerance alarm are optional.
- Alarm light is also available for quick-checking products' tolerance.
- 3 Buttons: On/Off, Inch/mm & ABS/PRESET
- Contact Point Thread: M2.5x0.45
- Stem Diameter: 8mm
- Standard CR-2032(3V) battery included.
- Flat back
- Fitted case

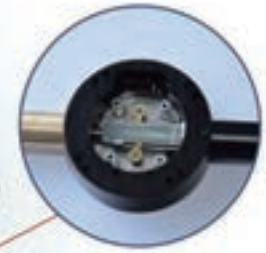

• Glass grating for high accuracy and stable performance



• Housing entirely cast made of high-strength aluminum alloy guaranteeing low deformation

GROUP 2

**INCH/METRIC
0.0005" GRADUATION**



- Temperature and humidity test for each product, ensuring the normal use of each in harsh environment



**Replacement
Contact Point
M2.5x0.45
5260-9999
\$175
(F)**

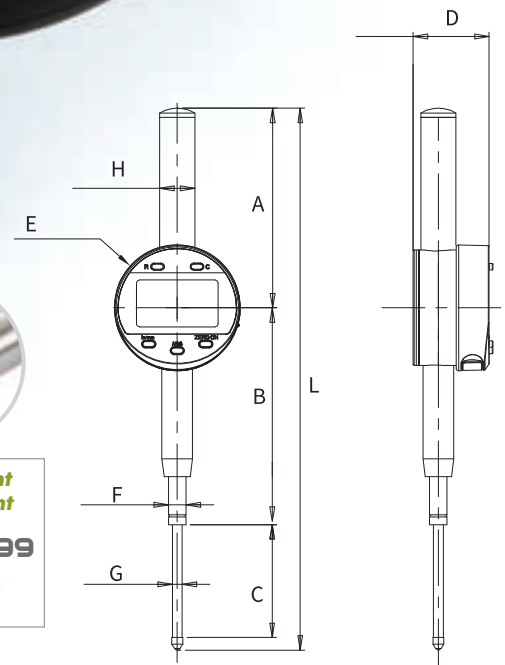

REPLACEMENT BATTERY (ITEM #4102-0032)....\$3.32

Item#	Range	Resolution	(mm)										Price (F)
			A	B	C	D	E	F	G	H	L		
5260-1105	0-0.5"/0-12.7mm	.0005"/.01mm	47.7	51.5	25.8	32.4	Ø57.4	Ø8h6	Ø4.5	Ø10	125	81.28	
5260-1110	0-1.0"/0-25.4mm	.0005"/.01mm	68	76	33	34.7	Ø57.4	Ø8h6	Ø4.5	Ø16	183	93.73	
5260-1115	0-2.0"/0-50.8mm	.0005"/.01mm	91	102.8	51.5	34.7	Ø57.4	Ø8h6	Ø4.5	Ø16	247	216.71	



Dasqua® ABSOLUTE DIGITAL ELECTRONIC INDICATORS -GROUP 2

- Positive, tactile-feel button activation.
- Data output.
- "+" or "-" direction set.
- High precision contact point.
- Flat back.
- Lug back optional.

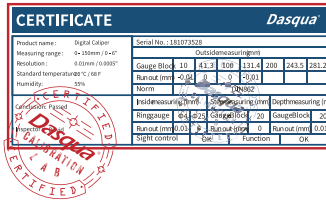

CABLE 01	Absolute
Data output	mm / in
BLUETOOTH TRANSMITTER	WIRELESS TRANSMITTER

GROUP 2

**INCH/METRIC/FRACTION
.0005" OR .00005" GRADUATION**

- Large rotatable LCD display with clear reading



- Low power consumption assures longer service life



- More function: On/Off button, Preset, Origin, ABS/Zero and mm/inch switchable, achieving multifunctional



Bluetooth Transmitter
2140-9998
\$4807
(F)



Cable
2140-9999
\$11203
(F)



Wireless Transmitter
2140-9997
\$14428
(F)

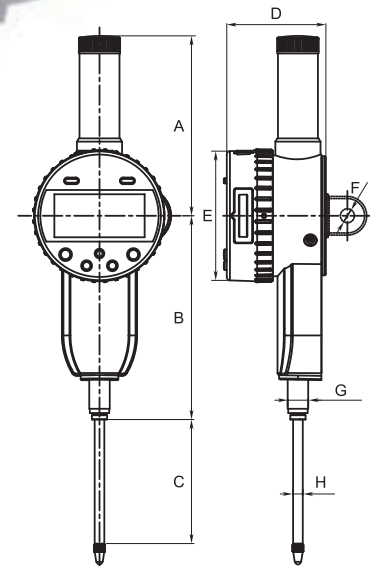

REPLACEMENT BATTERY (ITEM #4102-0032).....\$3.32

Item#	Range	Resolution	(mm)								Accuracy	Price (F)
			A	B	C	D	E	F	G	H		
5340-8105	0-1/2"/0-12.7mm	.0005"/.01mm	60.2	53.8	14.2	40.2	Ø60.1	Ø6.5	Ø8 or Ø1/8"	Ø4.5	.0005"/.01mm	129.43
5340-8110	0-1"/0-25.4mm	.0005"/.01mm	55.7	68.8	32.7	46.2	Ø61.1	Ø6.5	Ø8 or Ø1/8"	Ø4.5	.0005"/.01mm	155.30
5340-8115	0-2"/0-50.8mm	.0005"/.01mm	83.7	94.8	57.7	46.1	Ø61.1	Ø6.5	Ø8 or Ø1/8"	Ø4.5	.001"/.015mm	217.31
5340-9105	0-1/2"/0-12.7mm	.00005"/.001mm	60.2	53.8	14.2	40.2	Ø60.1	Ø6.5	Ø8 or Ø1/8"	Ø4.5	.00016"/.004mm	213.46
5340-9110	0-1"/0-25.4mm	.00005"/.001mm	55.7	68.8	32.7	46.2	Ø61.1	Ø6.5	Ø8 or Ø1/8"	Ø4.5	.00016"/.004mm	280.98
5340-9115	0-2"/0-50.8mm	.00005"/.001mm	83.7	94.8	57.7	46.1	Ø61.1	Ø6.5	Ø8 or Ø1/8"	Ø4.5	.0002"/.005mm	389.38

PRECISION DIAL TEST INDICATORS

- Dovetail mount top, back & front.
- Includes fitted case & 2 stems(5/32" & 3/8").
- Precision pivot bearing.
- 0.098" Contact point.
- Satin chrome finish.
- Jeweled movements.
- Automatic reversing.

Item#	Range	Graduation	Face	Reading	Price (F)
4400-0010	0~0.03"	.0005"	White	0-15-0	51.12
4400-0101	0~0.03"	.0005"	Yellow	0-15-0	51.12
4400-1001	0~0.03"	.0005"	Black	0-15-0	51.12
4400-0100	0~0.008"	.0001"	White	0-40-0	64.87

Replacement Point For 0~0.03"(Item #4400-1007) (M1.8 Thread).....\$3.75 (F)
Replacement Point For 0~0.008"(Item #4400-1008) (M2 Thread).....\$3.75 (F)



White Face
0~0.03" Range
4400-0010
\$51.12 (F)

Ultra-Series DIAL TEST INDICATORS

- Manufactured and inspected at world class factory that produces highest quality European brands.
- Three dovetail positioning mounts work with most existing test indicator accessories.
- Precision gear-driven design with smooth, jeweled movement.
- Contact point reverses automatically, always maintaining clockwise hand rotation.
- Frictionally adjustable contacts.
- Meets or exceeds ANSI/ASME accuracy specifications.
- High contrast, easy-to-read dials with white background.
- Satin chrome finish.

1-1/4"(32mm) DIAL FACE
INCLUDES CASE & 2 STEMS(5/32&3/8")



0~0.03" Range
Graduation .0005
4409-1201
\$54.89 (F)

0~0.008" Range
Graduation .0001
4409-1206
\$85.36 (F)

Ultra-Series DIAL TEST INDICATOR WITH DOVETAIL MOUNT

- Manufactured and inspected at world class factory that produces highest quality European brands.
- Three dovetail positioning mounts work with most existing test indicator accessories.
- Precision gear-driven design with smooth, jeweled movement.
- Contact point reverses automatically, always maintaining clockwise hand rotation.
- Frictionally adjustable contacts.
- Meets or exceeds ANSI/ASME accuracy specifications.
- High contrast, easy-to-read dials with white background.
- Narrow body for in reach ability.
- Satin chrome finish for durability.



Kit includes:
2-contact points,
2-dovetail clamps(stem 5/32&3/8"),
1-swivel post holder,
1-tool post holder,
1-contact wrench with fitted case.

0~0.03" Range
Graduation .0005
4409-1208
\$81.02 (F)

1-1/2" LARGE FACE, DIAL TEST INDICATORS

- Dial Face: 1-1/2" diameter
- Contact Point: .098"
- Dovetail mount top, back & front
- 2 stems (5/32 & 3/8") included
- Jeweled movements
- Satin chrome finish
- Automatic reversing
- With fitted case.

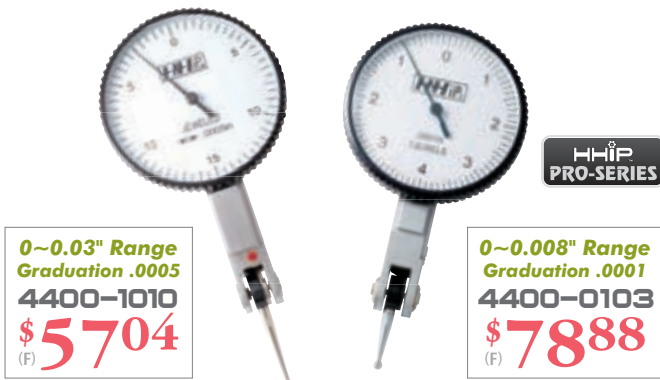

0~0.03" Range
Graduation .0005
4400-1010
\$57.04 (F)

0~0.008" Range
Graduation .0001
4400-0103
\$78.88 (F)

Replacement Point For 0~0.03"(Item #4400-1007) (M1.8 Thread)....\$3.75 (F)
Replacement Point For 0~0.008"(Item #4400-1008) (M2 Thread).....\$3.75 (F)

Ultra-Series LARGE FACE DIAL TEST INDICATOR

- Manufactured and inspected at world class factory that produces highest quality European brands.
- Three dovetail positioning mounts work with most existing test indicator accessories.
- Precision gear-driven design with smooth, jeweled movement.
- Contact point reverses automatically, always maintaining clockwise hand rotation.
- Frictionally adjustable contacts.
- Meets or exceeds ANSI/ASME accuracy specifications.
- High contrast, easy-to-read dials with white background.
- Satin chrome finish.



1-9/16" (40mm)
DIAL FACE

0~0.03" Range
Graduation .0005
4409-1203
\$59.90 (F)

2 stems (5/32 & 3/8") included

DIAL TEST INDICATORS

VERTICAL DIAL TEST INDICATOR

- Dovetail mounting top, back and bottom.
- Adjustable bezel and dial are easily set and reset to zero.
- Satin chrome finishing.
- Contact point can be displaced 210°.
- Includes 2 stems (5/32" & 3/8").

Range	Graduation	Reading
0~0.03"	.0005"	0-15-0



0~0.03" Range
4400-1002
\$7075
 (F)

METRIC DIAL TEST INDICATORS

- Precision pivot bearing.
- 2.5mm contact point.
- Satin chrome finish.
- Jeweled movements.
- Automatic reversing.
- Includes fitted case & 2 stems (6mm&8mm).
- Dovetail mount top, back, & front.



0~0.8mm Range
.01mm Graduation
4400-1004
\$4828
 (F)

0~0.2mm Range
.002mm Graduation
4400-1014
\$6552
 (F)

Interapid Style TEST INDICATOR & SET



5/32" Dia.

- Swiss type horizontal dial test indicator
- Automatic reversal
- Jeweled movement
- Dial reading 0-15-0
- Easy-to-read tilted dial
- Dial diameter: 1-1/2"
- 210° swivel arc.
- .080" steel contact point.

.0005 GRADUATION

Complete Kit
0~.060" Range
4400-0014
\$16666
 (F)

Indicator only
0~.060" Range
4400-1006
\$11427
 (F)

Case&2 Stems(5/32&3/8") Included

Kit Includes:

- 3 contact point (0.040", 0.080", 0.120")
- 2 dovetail clamps (sems 5/32", 3/8")
- Axial support
- Height gage bar with dovetail clamp-3/8" hole



Pro-Series LONG RANGE TEST INDICATOR

- Swiss style horizontal dial test indicator
- Automatic reversal
- Jeweled movement
- Dial reading 0-15-0
- Easy-to-read tilted dial
- 210° swivel arc.
- Dial diameter: 30mm(1.185")
- .080" carbide contact point.
- Very large measuring range.
- 4mm(5/32") swivel stem.
- With revolution counter.
- 2 Stems (5/32" & 3/8") included.
- With fitted case.

.0005 GRADUATION
Reading: 0-15-0

Range: 0~.060"
4400-1260
\$8642
 (F)

Limited Supply!



Dasqua® METRIC DIAL TEST INDICATORS

- A hard frame body providing excellent rigidity.
- White edge of dial for easy to read.
- Hardened and ground contact point.
- Satin chrome-finish case for durability.
- Shock resistant.
- Strictly made in accordance with DIN2270.
- Precision gear-driven design with smooth movement.

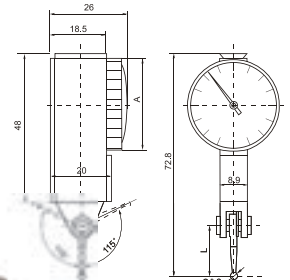

Item#	(mm) Range	Graduation	Casing Diameter (A)	Length of Stylus (L)	Price (F)
5221-0005	0.8	0.01	Ø30	16.5	58.27
5221-0000	0.8	0.01	Ø37.5	16.5	60.37

REPLACEMENT PARTS FOR Interapid Style INDICATORS



Item#	Description	Price (F)
4401-0731	1/4x1/2" Holding Bar with 1/4" pin	6.96
4401-0732	Stem 5/32" dia. with dovetail washer	4.91
4401-0734	Dovetail Clamp, bore dia. 1/4 & 3/8"	9.74
4401-0735	Replacement Point 0.04" (M1.4 thread)	5.95
4401-0736	Replacement Point 0.08" (M1.4 thread)	5.95
4401-0737	Replacement Point 0.12" (M1.4 thread)	5.95

Dasqua® DOUBLE RANGE TEST INDICATORS



- High precision contact point.
- 210° swivel arc.
- Jeweled bearing.
- Automatic reversal.
- Includes 3 contact points: 0.040", 0.080", 0.120" and 2 dovetail stem clamps.

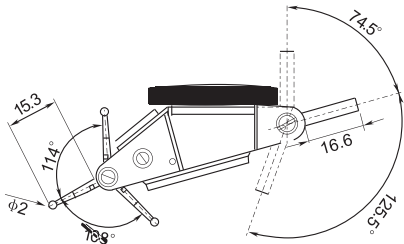

Unit: mm

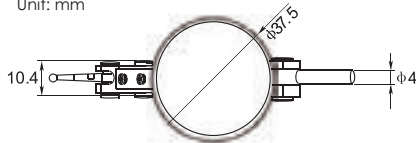

SHOCK-PROOF

Item#	Range	Reading	Dial	Dial Reading	Price (F)
5221-1115	1.6mm	0.01mm	25mm	0-40-0	120.43
5222-6110	0.060"	0.0005"	1.5"	0-15-0	117.21

Replacement Points for Inch or Metric Indicators

Item#	Description	Price (F)
5222-6003	Replacement Point 0.040" (M1.6 Thread)	9.56
5222-6004	Replacement Point 0.080" (M1.6 Thread)	9.56
5222-6005	Replacement Point 0.120" (M1.6 Thread)	9.56



Dasqua® DOUBLE RANGE DIAL TEST INDICATOR KIT

- Tough shock-proof gearing.
- A hard frame body providing excellent rigidity.
- White edge of dial for easy to read.
- Satin chrome-finish case for durability.
- Precision gear-driven design with smooth movement.
- With twice the range on large easy-to-read tilted dial.

.0005 GRADUATION
Reading: 0-15-0

0~0.060" Range
5222-6002
\$140.95
(F)



Kit includes:

- 3 contact points (0.040", 0.080", 0.120")
- 2 dovetail clamps (stems 5/32", 3/8")
- Axial support
- Height gage bar with dovetail clamp-3/8" hole

Replacement Points

Item#	Description	Price (F)
5222-6003	Replacement Point 0.040" (M1.6 Thread)	9.56
5222-6004	Replacement Point 0.080" (M1.6 Thread)	9.56
5222-6005	Replacement Point 0.120" (M1.6 Thread)	9.56

CENTERING INDICATORS

PRECISION CENTERING INDICATOR

- Quick, accurate, easy centering in boring and milling set-up on horizontal or vertical machines.
- Operates at an angle from horizontal to vertical machines, and from internal to external diameter without any change by simply changing the feeler.
- Face of the indicator remains stationary at any desired position while the machine spindle rotates, leaving the operator with both hands free to accurately position the table.

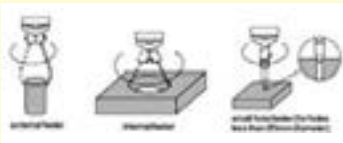

.0005" Graduation
4400-0020
\$142⁴⁵
 (F)

SPECIFICATIONS

Body Length:..... 5-1/2"
 Shank:..... 3/8" diameter x 7/8" long
 Weight:..... 9-1/2 OZ
 Feeler Ball:..... 1/8" diameter
 Measuring Range:..... 250 axis offset
 Capacity:..... Internal 5/32" to 4-1/4" dia. External 0 to 4-1/4" dia.
 Speed:..... Spindle rotation up to 800RPM (Exceeding this speed is not recommended)
 Locating Accuracy:..... 0.0002" of true center

Includes:

- Restraining rod
- Center point feeler
- 2" straight feeler
- 4" straight feeler
- 6" straight feeler
- 2" curved feeler
- 4" curved feeler
- 6" curved feeler

Pro-Series CENTERING INDICATORS

- Provides a simplified method of centering a workpiece or fixture on horizontal or vertical machines, internal or external diameters. Face of indicator remains stationary in any desired position while the machine spindle rotates, leaving the operator with both hands free to accurately position the machine table.
- Length: 6-7/8", Shank Dia.: 3/8", Feeler Dia.: 1/8".
- Locating accuracy within .0002" of true center.
- Operating speed not to exceed 800 RPM.
- Capacity: 5/32"-12" internal, up to 12" external.
- With fitted wooden case.

HHP PRO-SERIES



Kit Includes:

- 3 ID Feeler: 2, 3 & 4" long
- 3 OD Feeler: 2, 3, & 4" long
- 1 Center Locating Feeler

INCH
.0005" Graduation
4400-0120
\$178⁰⁰
 (E)

METRIC
0.01mm Graduation
4400-0121
\$178⁰⁰
 (E)



Dasqua® CENTERING INDICATORS

- Use this indicator to quickly center work pieces or fixtures on your bore and milling set-ups.
- Determining the centers of bores and shafts.
- Sturdy metal housing suitable for workshop.
- Internal or external centering.
- Operates at any angle from vertical to horizontal without a change.
- The shank is 10mm diameter and 20mm long.
- The indicator is 180mm long with 45mm straight feeler.
- Internal diameter is from 4mm to 300mm.
- External diameter is from 0mm to 300mm.
- Straight feeler length: 45mm/100mm/154mm.
- Curved feeler length: 46mm/100mm/154mm.
- Center point feeler length: 52.5mm.

Kit Includes:

- 3 internal & external feelers.
- Restraining arm
- Center point finder
- Wrench
- Fitted case

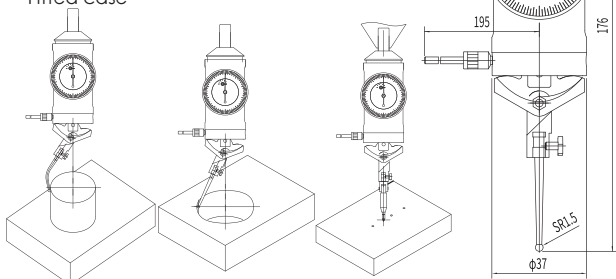

.0005" or .01mm GRADUATION

Item#	Range	Graduation	Accuracy	Price (F)
5711-6100	0-0.15"	0.0005"	0.001"	186.50
5712-1100	0-3mm	0.01mm	0.02mm	186.50

PRECISION TEST INDICATOR HOLDER & KIT

0~0.03" TEST INDICATOR

- Resolution: 0.0005"
- Precision pivot bearing.
- 0.098" Contact point.
- Satin chrome finish.
- Dovetail mount top, back, & front.
- 2 stems (5/32" & 3/8").
- Jeweled movements.
- Automatic reversing.



Holder Only
4401-0401
\$1669
(F)

Test Indicator Kit
4400-0013
\$6800
(F)
FITTED DURABLE PLASTIC CASE



UNIVERSAL TEST INDICATOR HOLDER

- 1-7/8" Clamping diameter.
- Length from center of clamping bracket to indicator: 6-1/2".
- Fits Bridgeport "J" head.

UNIVERSAL EXTENSION ARM

- Unique central locking mechanism.
- Both sides with male threads (M8x1.25x8mm VS 5/16"-18x8mm)
- Rigid universal steel arm.
- Extends up to 12"



4401-0113
\$3152
(F)

UNIVERSAL ARM FOR INDICATORS

- Rigid universal steel arm.
- Indicator stem hole: 8mm
- Unique central locking mechanism.
- Dovetail groove for clamping test indicator.
- Fine adjustment.
- Arm length 11"
- Rod side dimension (dia.x L): 8mmx40mm



4401-0115
\$3856
(F)

Z-Limit QUILL CLAMP HOLDER



- Manufactured and inspected at world class factory that produces highest quality European brands.
- Fits Bridgeport type milling machines.
- Fits milling machines with 1-7/8" dia. quills.
- Clamps directly onto machine quill.
- Will not disturb working tool in the machine.



INDICATOR IS NOT INCLUDED

4409-0010
\$2416
(F)

MINI UNIVERSAL ARM FOR INDICATORS

- Unique central locking mechanism.
- Dovetail groove for clamping test indicator.
- Indicator stem hole: 8mm
- Rigid universal steel arm.
- Arm length 6"
- Rod side dimension (dia.x L): 8mmx40mm



Standard Shown

Standard
4401-0117
\$3200
(F)

Fine Adjustment
4401-0118
\$3416
(F)

HALF-ROUND COMBINATION HOLDER

- Versatile holder for test indicators equipped with stems or dovetails
- 1/4 x 2" long holding bar
- Accepts 5/32" stem or dovetails
- 3-1/2" effective measuring range



INDICATOR IS NOT INCLUDED

4401-0412
\$2058
(F)

AXIAL SUPPORT BRACKET

- Used for mounting indicators with dovetails or rods
- 3/8" diameter body for secure support
- Multi-position, 360° capability
- .375" shank
- Constant tension
- 6.500 radial sweep



4401-0740
\$1792
(F)

MADE IN USA
4401-0741
\$4569
(F)

MINI UNIVERSAL ARM W/FINE ADJUSTMENT

- Unique central locking mechanism.
- Dovetail groove for clamping test indicator.
- Indicator stem hole: 8mm
- Fine adjustable knob.
- Arm length 6"
- Thread side: M8x1.25x8mm



4401-0116
\$3367
(F)

INDICATOR ACCESSORIES

ZERO-SET UNIVERSAL KIT FOR TEST INDICATORS

- Designed for test indicator with dovetails or 1/4" post and functions as a quick and practical work positioning device
- Setting up a workpiece before machining, or aligning the center of a round workpiece in relation to the cutting head, takes virtually no time with "Zero-Set".
- The hardened clamping post consists of three O.D.'s (1/4, 3/8 & 1/2")
- It reaches anywhere within a 8" diameter and fine-adjusts about 3/8" with knob.



Indicator Not Included

4401-0423
\$**43⁹⁷**
(F)

ZERO SET UNIVERSAL ATTACHMENT

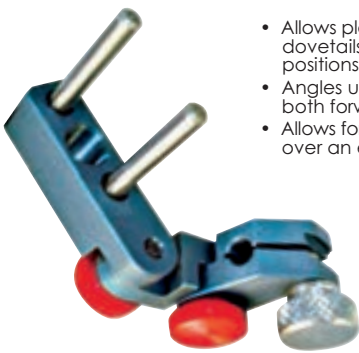

- Allows placement of any test indicator with dovetails or 1/4" posts in a multitude of positions
- Angles up to 90° on either side and bends both forward and backward
- Allows for an infinite range of measurement over an extensive area

Limited Supply!

4401-0422
\$**21¹⁶**
(F)

HEIGHT GAGE ATTACHMENT CLAMP SET

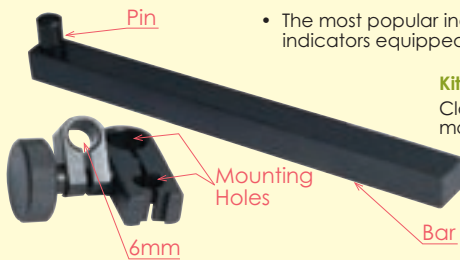

- The most popular indicator clamp. Fits all indicators equipped with rods or dovetails

Kit includes:
Clamp with dovetail and mounting holes

Item#	Mounting Holes	Bar	Pin	Price (F)
4401-0419	5/32 & 1/4"	5/16 x 5/16 x 3"	6mm	19.40
4401-0420	6 & 8 mm	9 x 9 x 75mm	6mm	19.40
4401-0421	7/32 & 3/8"	3/8 X 3/8 x 4"	6mm	19.40

ADAPTER CLAMP

- Adapter for mag. base, indicator stems and connect rods
- Rigid steel construction.
- Bore Diameter: 5/32, 1/4 & 1/4"

4401-0123
\$**11⁶³**
(F)



SWIVEL HEAD CLAMPING HOLDERS

- Rigid steel construction
- Dovetail groove for clamping test indicators
- Bores for indicators' stem

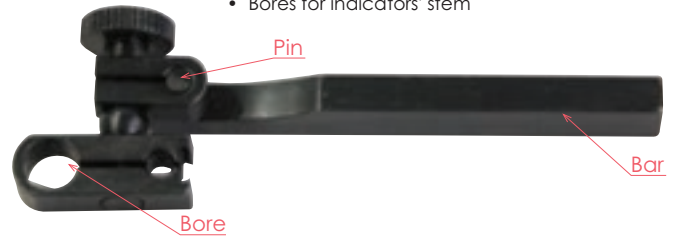

Item#	Bore	Bar	Pin	Price (F)
4401-0450	5/32 & 1/4"	1/2 x 1/4 x 3"	1/4	17.39
4401-0453	5/32 & 3/8"	1/2 x 1/4 x 3"	1/4	17.39
4401-0456	1/4 & 3/8"	1/2 x 1/4 x 3"	1/4	17.39

DOVETAIL INDICATOR CLAMPS

- 3" overall length
- For use with all test indicators and probes with dovetails
- Locks in four 90° quadrants



Item#	Dia. of Rod	Price (F)
4401-0426	1/4"	17.39
4401-0427	6mm	17.39
4401-0428	8mm	17.39

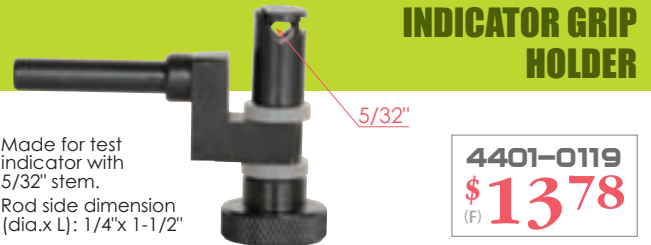

INDICATOR GRIP HOLDER

- Made for test indicator with 5/32" stem.
- Rod side dimension (dia.x L): 1/4"x 1-1/2"

4401-0119
\$**13⁷⁸**
(F)

DOVETAIL CLAMPS

- Rigid steel construction
- Dovetail groove for clamping test indicators
- Bores for indicators' stem

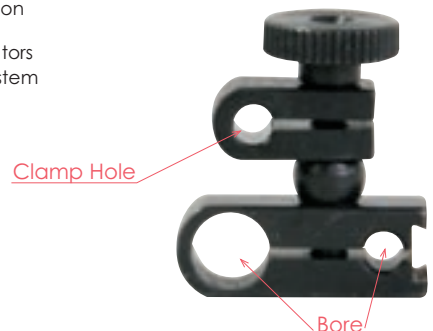

Item#	Bore	Clamp Hole	Price (F)
4401-0466	6 & 8mm	6mm	11.02
4401-0467	4 & 6mm	4mm	11.02
4401-0468	5/32 & 3/8"	1/4"	11.02
4401-0469	1/4 & 3/8"	4mm	11.02
4401-0470	5/32 & 1/4"	5/32"	11.02

Pro-Series FLEX & RIGID RULES

Style	Graduation
4R.....	8ths & 16ths, 32nds & 64ths
5R.....	32nds & 64ths, 10ths & 100ths
16R.....	32nds & 64ths, 50ths & 100ths
3R.....	32nds & 64ths, 10ths & 50ths
E/M.....	32nds & 64ths, mm & .5mm

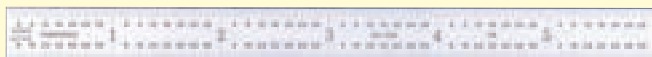

- Made from the finest steel available.
- All fully hardened, tempered and chrome finished.
- Precisely etched for accuracy and readability.

Length (Inch)	Style	FLEX Item#	Width (Inch)	Price (E)	RIGID Item#	Width (Inch)	Price (E)
6	4R	4901-0131	1/2	10.97	4901-0201	3/4	11.04
12	4R	4901-0132	1/2	20.49	4901-0202	1	20.46
24	4R	4901-0134	3/4	49.40	4901-0204	1-1/8	51.69
36	4R	4901-0136	3/4	102.93	4901-0206	1-1/4	107.64
48	4R	4901-0138	3/4	154.85	-----	-----	-----
6	5R	4901-0140	1/2	10.97	-----	-----	-----
12	5R	4901-0142	1/2	20.09	4901-0212	1	20.46
24	5R	4901-0144	3/4	49.40	4901-0214	1-1/8	51.69
36	5R	4901-0146	3/4	103.00	-----	-----	-----
48	5R	4901-0148	3/4	154.85	-----	-----	-----
6	16R	4901-0150	1/2	10.97	4901-0220	3/4	11.04
12	16R	4901-0152	1/2	20.49	4901-0222	1	20.46
24	16R	4901-0154	3/4	49.40	4901-0224	1-1/8	51.69
36	16R	-----	-----	-----	4901-0226*	1-1/4	53.82
6	3R	4901-0161	1/2	10.97	4901-0231	3/4	11.04
6	E/M	4901-0166	1/2	10.97	4901-0236	3/4	11.04
12	E/M	4901-0168	1/2	21.25	4901-0238	1	20.46

* Limited Supply

STAINLESS STEEL RULE

- Hardened stainless steel.
- Flexible.

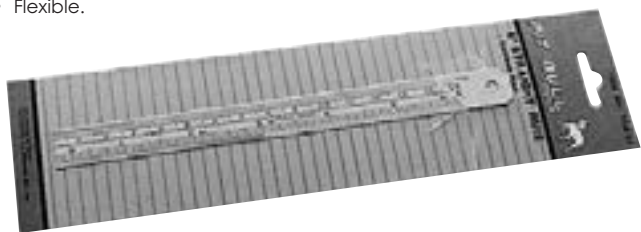

Item#	Size	Reading	Price (F)
7019-0001	6'/15cm	3R-16ths, 32nd, 1mm	3.32

POCKET STAINLESS STEEL RULES

- Made from hardened stainless steel.
- Graduations are properly etched for accurate measurements.
- Packed in attractive PVC jacket.
- Clip included.

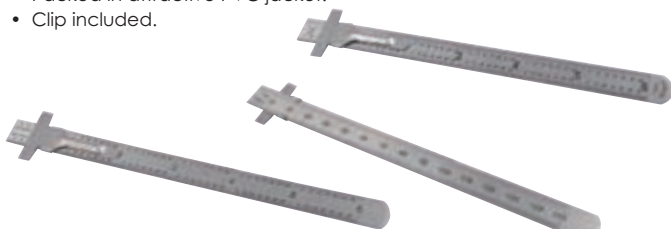

Item#	Length x Width	Reading	Price (F)
7006-0001	6 x 15/32"	32nds, 64ths & Decimal Equiv.	2.20
7006-0003	6 x 15/32"	E/M-32nds, 64ths, mm & 0.5mm	2.20

MULTI-USE RULE & GAUGE

- This indispensable pocket tool performs six separate functions: drill point gauge, bevel protractor, circle center finder, circle divider, tap and drill table and 4" rule with etched graduations 0 in 64ths and millimeters.



4906-0100
\$914
(F)

STEEL PROTRACTORS

- Measures angles from 0 to 180°.
- Used for drawing radial lines, transferring angles and setting bevels.
- Blade secured firmly by lock nut at any angle.
- Made of tempered steel with satin chrome finish.
- Semi-circle Head Radius: 2"
- Features 6" arm and knurled thumb locknut.

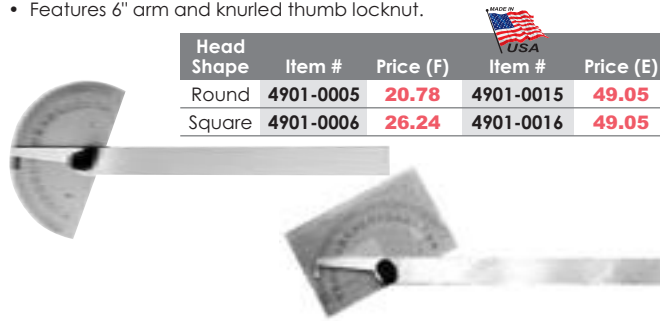

Head Shape	Item #	Price (F)	Item #	Price (E)
Round	4901-0005	20.78	4901-0015	49.05
Square	4901-0006	26.24	4901-0016	49.05

5PC MEASURING & MARKING SET

- Made of hardend tool steel.
- Set consists of one of each:
 - Machinest Square: 6" (6" Blade x 4" Beam)
 - Center Finder Square: 1-1/2"
 - Round Head Protractor
 - Carbide Tipped Scriber with magnet other side.
 - Center Punch: 4"
- Complete in a fitted ABS case



5PC SET
4906-0105
\$6950
(F)

DRILL POINT GAGE

NEW

- For properly grinding 59° drill points and for measuring drill tips.
- Rule and slide are made of steel with satin chrome finish.
- 6" rigid rule is calibrated in 8ths, 16ths, 32nds and 64ths.
- End clip is adjustable and removable.
- Slide is calibrated in 32nds and 64ths.

4906-0110
\$925
(F)



PROTRACTORS

Dasqua® 0-180° OPEN HEAD PROTRACTOR

- Multi-purpose, engineering drawing, angle measurement, architectural design, woodworking, length measurement, etc.
- Packaged in a beautiful and durable leather bag.
- Measures angles from 0-180°
- Useful and accurate tool for setting bevels, transferring angles, and small squaring tasks.
- Blade secured firmly at any angle by a lock joint and knurled screw.
- Satin chrome finish for easy reading and resistance to rust.
- Hardened stainless steel.

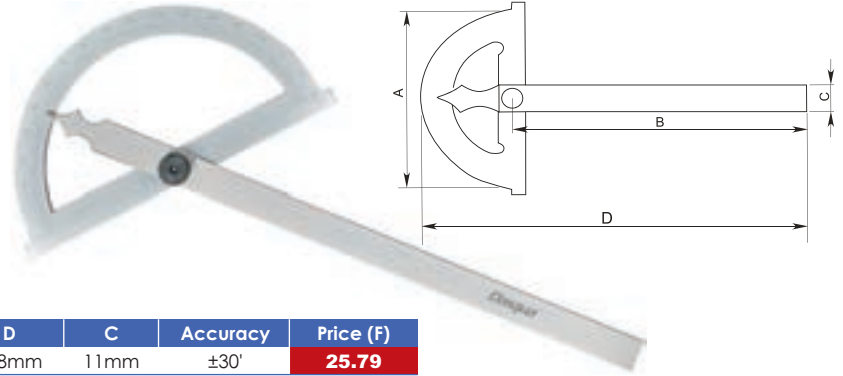

Item#	Range	Graduation	Size (AxB)	D	C	Accuracy	Price (F)
1012-1005	0-180°	1°	80x120mm	168mm	11mm	±30'	25.79

Dasqua® 0-360° UNIVERSAL DIAL PROTRACTOR

- Made of stainless steel.
- With a dial for easy and accurate reading.
- Measuring surface hardened, ground and lapped ensures smooth movement.
- Satin chrome finish, anti-rust and durable.
- Provided with three blades (6", 8", 12")
- Indicator pointer shows each degree.
- Packed in fitted case.

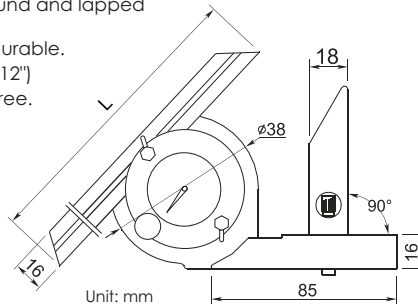

Item#	Range	Graduation	L	Accuracy	Price (F)
1031-2010	0-360°	5'	6"/150mm, 8"/200mm, 12"/300mm	±5'	168.87

Dasqua® 0-360° UNIVERSAL DIGITAL ELECTRONIC PROTRACTOR

- High contact display.
- All measuring face are hardened, ground and lapped.
- Hardened stainless steel.
- With fine adjustment.

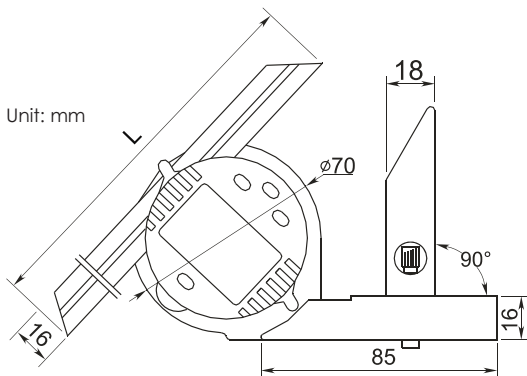

Data Output



REPLACEMENT BATTERY (ITEM #4102-0032)....\$3.32

Item#	Range	Reading	L	Accuracy	Price (F)
1021-2005	0-360°	1'	6"/150mm, 8"/200mm, 12"/300mm	±5'	495.56

Dasqua® 4 PC COMBINATION SQUARE SET

- Made by procoated mold and no blister on the surface.

- Low surface roughness and high accuracy with surfaces precisely ground.

- Powder-coated process guaranteeing high surface durability.

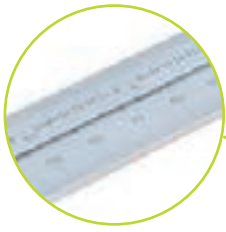

- Distinct lines and figures against the satin chrome finish making reading easily.

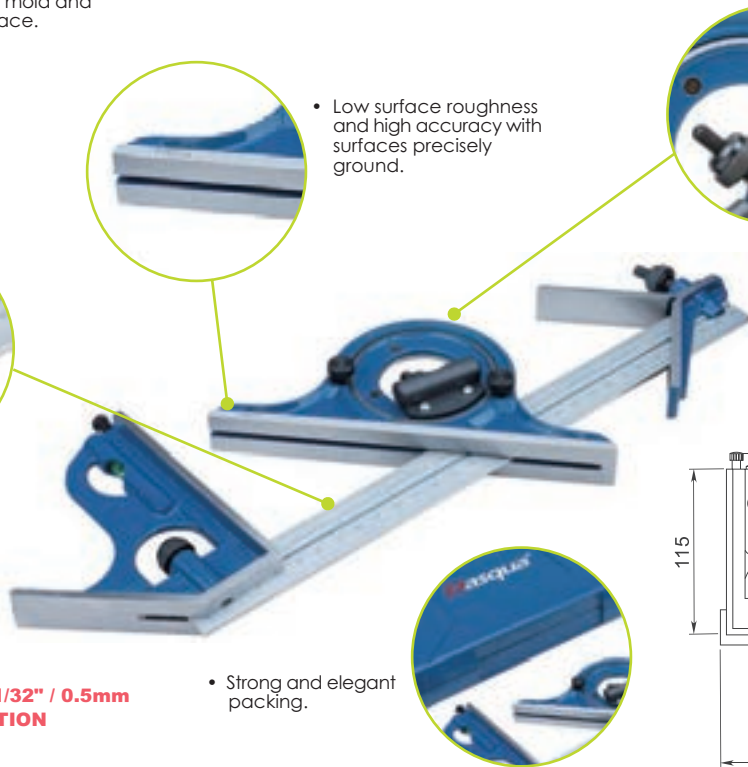

0-180°
300mm/12" Blade
1012-2010
\$121.19
(F)

1/64" / 1.0mm & 1/32" / 0.5mm
GRADUATION

- Strong and elegant packing.

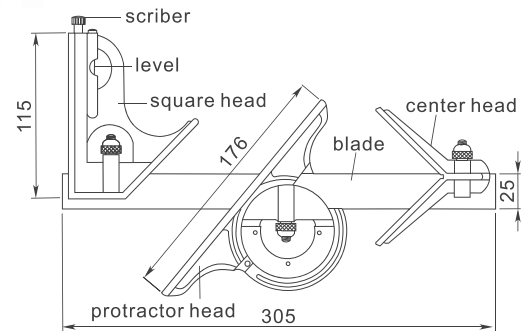

4PC COMBINATION SQUARE SET

- Set includes: square head, center head, protractor and blade.
- Double indexed protractor is graduated 180° in both directions.
- Graduation: 4R-8ths, 16ths, 32nds, 64ths
- Blade made of hardened stainless steel.
- Microfine graduation.
- Accuracy ±15'.

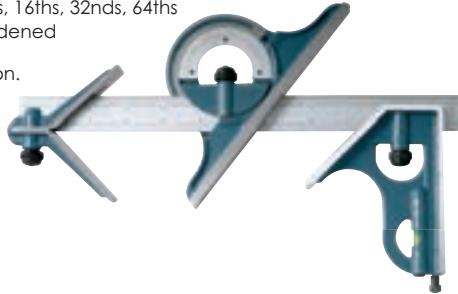

0-12" Blade
4901-0003
\$75.90
(E)

16R Blade (32nds, 64ths, 50ths & 100ths) Item# 4901-0316*\$16.06(F)
Satin Chrome Finish * Limited Supply

3PC COMBINATION SQUARE SET

- Microfine graduation.
- Easy-to-ready blade is fully hardened and tempered
- Square head has level and scriber point
- Graduation: E/M 0.5mm & 32nds, 1.0mm & 64ths.
- Blade satin chrome finish.



0-12" Blade
4901-0314
\$46.27
(E)

UNIVERSAL DIAL PROTRACTOR SET

- The measuring value can be read on the dial indicator.
- An inspection window reads a full 360° with four 0-90° sections.
- Hardened stainless steel construction throughout this tool.
- It can be used as a ruler, straight edge, cross or miter square.
- Blades are beveled at 45° on one side and 60° on the other side.
- Blade Length: 6, 8-1/2, 12"

WITH 3 BLADES



0-360° Range
4901-0001
\$80.76
(F)

Limited Supply!

DOUBLE SQUARES

- Made of steel hardened and satin chrome finished.
- Slide is adjustable and removable.
- 4R: 8ths & 16ths, 32nds & 64ths

Limited Supply!

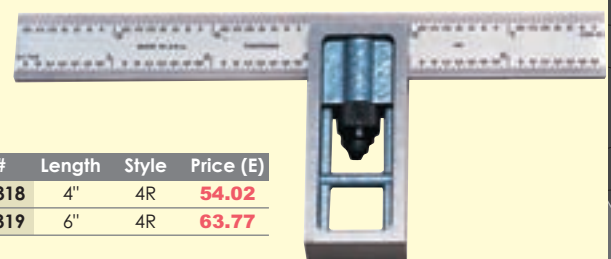

Item#	Length	Style	Price (E)
4901-0318	4"	4R	54.02
4901-0319	6"	4R	63.77

SQUARES & SETS

MACHINIST STEEL SQUARES & SETS



- Made of high grade tool steel & hardened spring steel, blades have a ground finish.
- Accurate right angles both inside and outside.
- Precision ground.

4 PC SET
2, 3, 4 & 6"
4906-0018
\$**48**⁴⁰
(F)

4906-0020 Shown

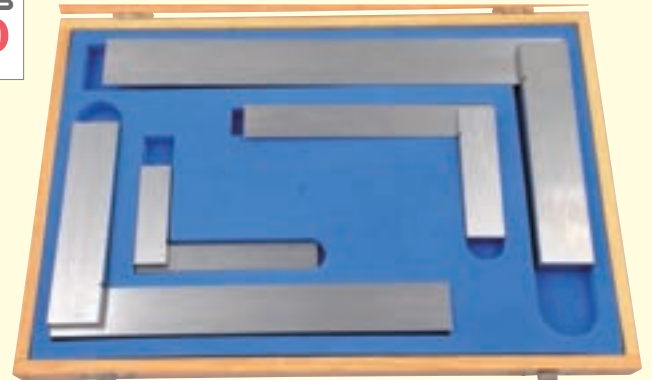

Item#	Blade Length	Beam Length	Price (F)
4906-0003	3	2.5	6.60
4906-0004	4	3.0	7.04
4906-0006	6	4.0	10.12
4906-0008	8	5.0	11.88
4906-0009	9	6.0	26.84
4906-0012	12	8.0	24.20

4 PC SET
4, 6, 9 & 12"
4906-0020
\$**87**¹²
(F)

HHIP MACHINIST STEEL SQUARES & SET

- Made from fully seasoned tool steel.
- Accurate right angles both inside and outside.
- Fully hardened.
- Beam ground and lapped.

4 PC SET
2, 3, 4 & 6"
4901-0014
\$**61**⁴²
(F)

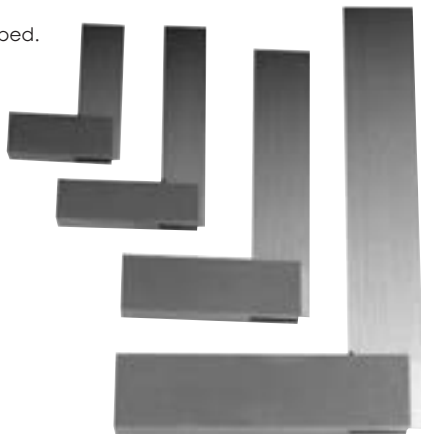

4 PC SET
4, 6, 9 & 12"
4901-3015
\$**93**⁸⁴
(F)

Item#	Blade Length	Beam Length	Squareness of Blade to Working Face	Price (F)
4901-0602	4"	3"	0.001"	13.09
4901-0604	6"	4"	0.001"	19.98
4901-0906	9"	6"	0.0015"	32.56
4901-1208	12"	8"	0.002"	49.34

Pro-Series SOLID SQUARES

- Made from tool steel, hardened and ground.
- Accurate right angles both inside and outside.

4 PC SET
2, 3, 4 & 6"
4901-0598*
\$**93**⁰²
(F)



* Limited Supply

Item#	Blade Length	Beam Length	Price (E)
4901-0590	2"	1-1/2"	26.57
4901-0591	3"	2-1/2"	28.06
4901-0592	4"	3"	30.72
4901-0593	6"	4"	35.47
4901-0594	9"	6"	102.26
4901-0595*	12"	8"	118.94
4901-0598*	Set of 2,3,4 & 6"		93.02
4901-0599*	Set of 4,6,9 & 12"		225.46

ROUND BAR CENTER FINDERS

- Very useful to find the centers on any round object.
- Can be held in collets or drill chucks.
- Shank: 3/8"

4406-0027
\$**5**⁷²
(F)

4401-0027
\$**26**⁶⁶
(E)



MACHINISTS CENTER SQUARES

- For rapid location of exact center of round, square and octagonal parts.
- Made from precision ground tool steel.
- Hardened and tempered blade.
- To execute place the item between the center square. Scribe different lines on the workpiece each time changing its position. Center of the scribed lines will give the accurate center of the work piece.

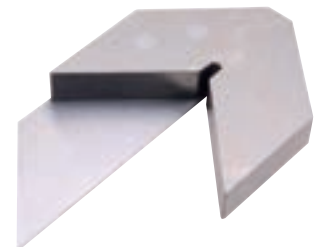

Range:
Up to 1-1/2" Diameter
4901-0351
\$**18**⁸⁵
(F)

Range:
Up to 3" Diameter
4901-0354
\$**33**⁷⁰
(F)



Z-Limit BEVEL EDGE SQUARES



- Manufactured and inspected at world class factory that produces highest quality European brands.
- Made of high grade stainless steel, hardened and ground.
- Accurate right angles both inside and outside

Tolerance(Squareness): +/- .0002"

Item#	Blade Length	Beam Length	Price (F)
4909-0003	3	2	51.61
4909-0006	6	4	36.30
4909-0008	8	5	137.63

Limited Supply!

90° WIDE BASE SQUARES



- Used for checking squares.
- Wide base for easy free standing.
- Hardened and both ends are lapped.
- Absolute 90° angle.

Item#	Blade Length	Beam Length	Price (E)
4901-1213	3"	2"	19.45
4901-1214	4"	3"	23.72
4901-1216	6"	4"	33.39
4901-1218	8"	5"	49.03

.0002" SQUARENESS

PRECISION BEVEL EDGE SQUARES

- Squares have accurate right angles both inside and outside.
- Beveled blade on both sides.
- Made from a single piece of fully seasoned tool steel.
- Fully hardened.
- Beam ground and lapped.
- Accuracy class H.

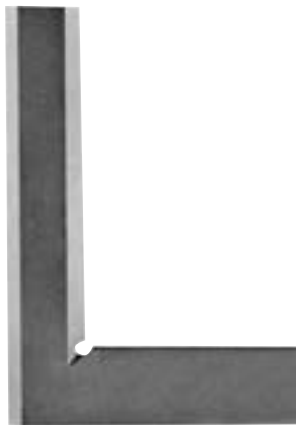

4 x 2-1/2"
4901-0022
\$3319
(F)

6 x 4"
4901-0023
\$3531
(F)

4PC DIEMAKER'S SQUARE SET

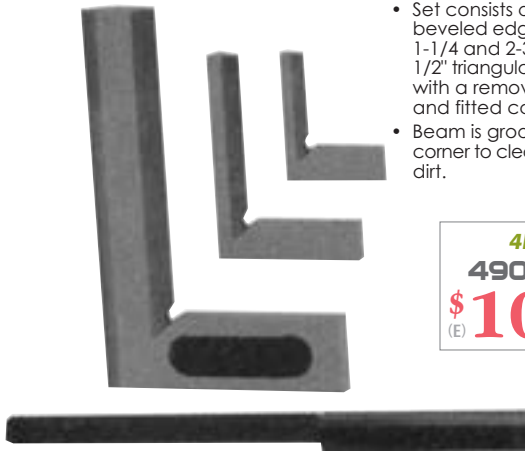

- Set consists of 3 hardened beveled edge squares (3/4, 1-1/4 and 2-3/8") plus a 1-1/2" triangular straight edge with a removable handle and fitted case.
- Beam is grooved at inner corner to clear out burrs and dirt.

4PC Set
4901-0018
\$10931
(E)

PRECISION CYLINDRICAL SQUARES

- Used for checking squares, height gages and many instruments.
- Easy to access from any angle around it.
- Hardened and both ends are lapped.
- Absolute 90° angle.



Item#	Dimension Dia.	Height	Squareness	W.T. (lbs.)	Price (E)
4901-2601	3"	6"	± 0.00010"	13	181.88
4901-2602	4"	12"	± 0.00015"	45	259.83

PRECISION GRANITE SQUARES



- To squareness check and for inspection purposes.
- Round hole for less weight and easy handling (larger size with multi-holes).
- Complete with inspection certificate.

Item#	H x W x Thick	Squareness	Wt. (lbs.)	Price (F)
4901-2705	10x 6x 1"	0.0002"	6	230.75
4901-2706	15x10x1.5"	0.00028"	18	412.50

DIGITAL PROTRACTOR & ANGLE GAGES

Dasqua® DIGITAL ELECTRONIC PROTRACTOR

Absolute IP65 COOLANT & FLUID RESISTANT

- Absolute function, zero setting is unnecessary when the battery is replaced.
- Used as level and inclinometer to measure the included angle of non-continuous working surfaces.
- V-groove base with powerful embedded magnets, which secures strong attachment to the measuring surfaces (including cylindrical surface).
- Backlight function enables it to use in the dim plac.
- IP65 dust-proof and water-proof.

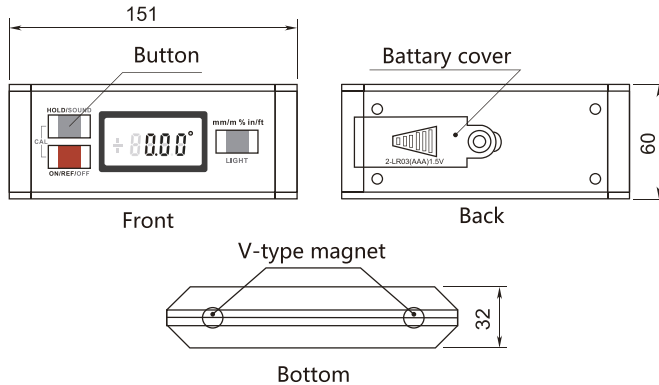

Item#	Range	Resolution	Accuracy	Price (F)
8400-0005	4 x 90°	0.1°	0°-90°: ±0.05° Rest of angle: ±0.15°	97.40

Dasqua® DIGITAL ELECTRONIC ANGLE GAGE

NEW

- Large easy-to-read backlight LCD display.
- Absolute 0° measuring at level surface.
- Measure relative bevel.
- With permanent strong magnet on measuring faces.
- CNC machined aluminum body.

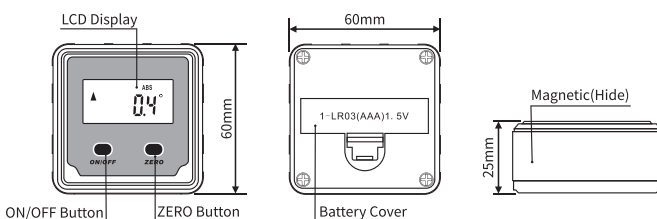

Item#	Range	Resolution	Accuracy	Price (F)
8400-0010	4 x 90°	0.1°	±0.2°	34.97

Dasqua® 180° DIGITAL ELECTRONIC GAGE WITH FLIP-OUT DISPLAY

- With flip-out tilting display.
- Ultra-precise magnetic gage sets the angle of saw blades jointer fences, bandsaw tables and drill press tables.
- Measures both absolute level and relative bevel with readings that are always visible.
- V-groove in base for round objects like pipe and drill bits.



Item#	Range	Resolution	Accuracy	Repeatability	Size	Price (F)
8400-0000	±180°	0.1°	±0.1°	±0.1°	2.2x2.3x1.3"	73.45

MASTER PRECISION LEVELS

- Graduation: 0.0005" per 10" .
- For accurately checking the work of machinists and toolmakers setting up machinery and other work that requires extreme leveling accuracy.
- Ground and graduated main vial of 10 second accuracy.

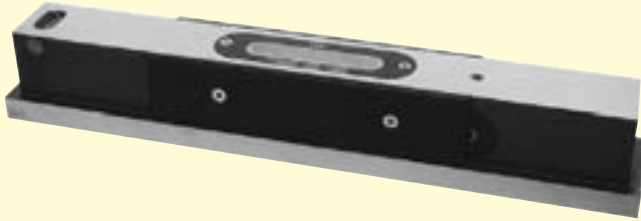

Item#	Length	Price (F)
4901-0084	4"	87.03
4901-0081	8"	109.88
4901-0008	12"	147.45

INSPECTION BLOCK LEVELS WITH 2 VIALS

- For accurately checking the work of machinists and toolmakers setting up machinery and other work that requires extreme leveling accuracy.
- Feature a cross and main vial that is easily adjustable. They are heat insulated and are resistant to shock.
- 0.0005 Graduation Sensitivity per 10 Inch.



Item#	Length	Price (F)
4901-0086	6"	137.49
4901-0088	8"	160.47
4901-0092	12"	192.63

Dasqua® MASTER PRECISION LEVEL

DIN 877

- Strictly made in accordance with DIN877.
- Used to measure the straightness and flatness of machine guide rails.
- Robust cast iron model, precision ground measuring surface ensures high accuracy.
- Base with V-groove to allow use on round bars and shafts, cylindrical surfaces.
- With main vial and cross test vial



**10 Second Accuracy!
1 Division Equals 0.0005" Per 10"**

Item#	Range	Graduation	Price (F)
8302-0005	6"	0.0005"	109.82
8302-0010	8"	0.0005"	116.64
8302-0015	10"	0.0005"	135.72
8302-0020	12"	0.0005"	160.29



Dasqua® PRECISION FRAME SPIRIT LEVELS

DIN 877

- Strictly made in accordance with DIN 877.
- Used to measure the straightness and flatness of machine guide rails.
- Robust cast iron model, precision ground measuring surface ensures high accuracy.
- Base with V-groove to allow use on round bars and shafts.
- The adjustable glass bubble is highly sensitive and easy to read.
- Lapped, hardened and polished steel body.



.0005" GRADUATION

Item#	Range	Graduation	Price (F)
8302-0003	6x6"	0.0005"	128.91
8302-0006	8x8"	0.0005"	138.45
8302-0009	10x10"	0.0005"	169.83
8302-0013	12x12"	0.0005"	203.94

PRECISION FRAME SPIRIT LEVELS

- This level comes with frame level and master level
- With fitted case

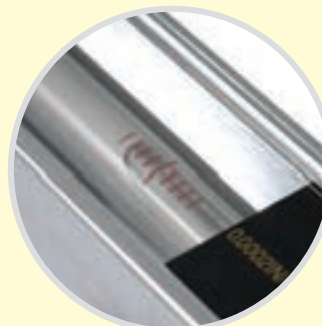

.0005" GRADUATION

Item#	Range	Graduation	Price (F)
4901-0077	6 x 6"	0.0005"	128.23
4901-0078	8 x 8"	0.0005"	130.73
4901-0007	12 x 12"	0.0005"	198.48

HEIGHT GAGES

CARBIDE SCRIBERS & CLAMP FOR HEIGHT GAGES

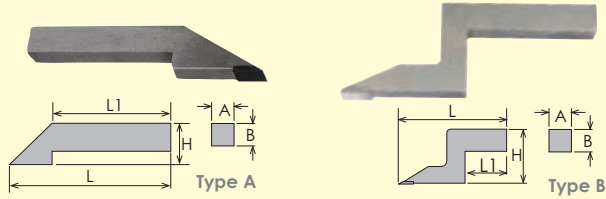

Unit: Inch

Scriber Item#	Type	L	L1	H	A	B	Price (F)
4300-0016	A	2.15	1.3	0.5	0.23	0.33	26.73
4300-0035	B	1.7	0.8	1.3	0.23	0.32	26.73
4300-0126	B	3.2	1.6	1.2	0.35	0.35	26.73
3001-4105	B	2.52	1.1	1.9	0.20	0.31	20.33
3110-4120	B	3.15	1.4	1.6	0.35	0.35	37.33
3110-4125	B	8.0	4.3	1.9	0.39	0.63	84.93
3130-4115	B	2.57	1.6	1.2	0.50	0.25	27.13
3130-4125	A	4.13	2.6	1.4	0.39	0.47	33.93
3130-4130	B	4.33	2.6	1.5	0.39	0.59	57.73

Clamp Item#	h	a	h1	b	t	Price (F)
4300-0151	1.34	0.79	0.80	0.59	0.355	20.68

Z-Limit 12"/300MM VERNIER HEIGHT GAGE

- Manufactured and inspected at world class factory that produces highest quality US brands.
- Made of stainless steel.
- The finest of vernier scribers for accurate work.
- Satin-chrome finished scale and vernier.
- .001"/.02mm reading.

0~12"/0~300mm Range
4309-0002
\$17709
 (F)

Limited Supply!

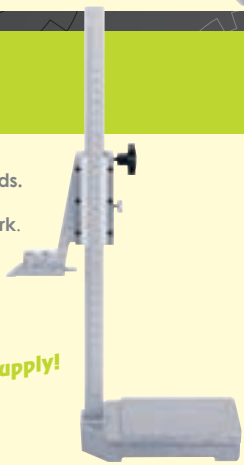

DIAL HEIGHT GAGES

- Made of high quality stainless steel and satin chrome finish.
- Carbide tipped scriber for longer life.
- Fine feed adjustment.
- Positive lock screw.
- Come with fitted case.

.001" GRADUATION

Item#	Range	Price (F)
4300-0028	0~6"	100.38
4300-0029	0~8"	112.25
4300-0030	0~12"	140.93

Replacement Scriber
 (see above for dimensions)

Scriber Item#	Price (F)
4300-0035	26.73

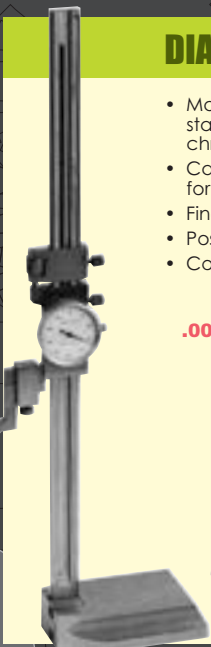

Dasqua®

DOUBLE-BEAM DIAL HEIGHT GAGE

- Provided with a dial and two digit counters for more accurate reading.
- Double-beam ensures higher measuring accuracy.
- One counter reads in the plus direction and the other reads in the minus direction.
- With a feed wheel on the back.
- Carbide tipped scriber for sharp, clean lines.
- Both counters and dial can be re-zeroed at any scriber position.
- Base hardened, ground and lapped for maximum flatness.
- Dustproof shield optional.

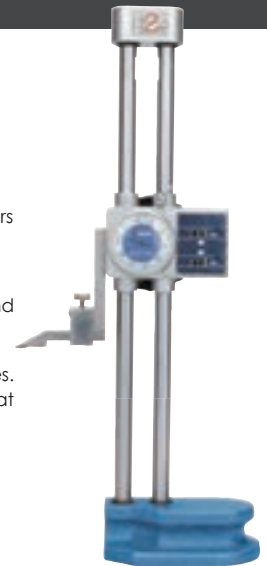

Item#	Range	Resolution	Graduation	Price (F)
3222-4205	0-12"	0.001"	0.1"	304.30

Z-Limit DIAL HEIGHT GAGE

- Manufactured and inspected at world class factory that produces highest quality European brands.
- Fine feed adjustment with positive lock.
- Other side of scriber has a pin to attach indicator clamp and dovetail.
- Made of high quality stainless steel.
- Scriber is carbide tipped.
- Complete with fitted case.

Limited Supply!



CLAMP SHOWN INCLUDED



Z-Limit
 ULTRA-SERIES

.001" GRADUATION

0~24" Range
4309-0024
\$29900
 (F)

Dasqua®

ABSOLUTE DIGITAL ELECTRONIC HEIGHT GAGE

- Built-in absolute liner encoder, no need to set the reference point at every power-on.
- Carbide tipped scriber for sharp, clean lines.
- With SPC data output.
- Large, easy-to-read LCD display.
- Rigid, heavy duty beam and base.
- Made of stainless steel.

- Absolute
- Data output
- mm/inch

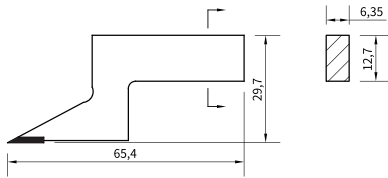

Replacement Scriber (Item# 3130-4115)....\$27.13
(see page 67 for dimensions)

Item#	Range	Resolution	Accuracy	Price (F)
3130-8115	0-300/0-12"	0.01/0.0005"	±0.04	270.69

Z-Limit DIGITAL ELECTRONIC HEIGHT GAGES

- Manufactured and inspected at world class factory that produces highest quality European brands.
- Made of high quality stainless THROUGHOUT.
- Function Keys: On/Off/Zero, mm/inch, Tol, ABS, Hold and Set.
- Power: SR 44, 1.55V battery (included).
- True inch/metric conversion.
- Complete with fitted case.
- Scriber is carbide tipped .
- Fine adjustment.



Limited Supply!



INCH/METRIC
.0005"/.01mm RESOLUTION

Item#	Range	Price (F)
4309-0112	12"/300mm	311.59
4309-0124	24"/600mm	638.29

Replacement Battery (Item #4102-0030)....\$3.19

DIGITAL ELECTRONIC HEIGHT GAGES WITH SPC OUTPUT

- Made of stainless steel throughout.
- Fine adjustment control for smooth movement
- Inch/mm conversion
- ABS and Inc. mode.
- Zero setting.
- Carbide tipped scriber
- With RS232 output port.
- Standard CR-2032(3V) battery included.

Limited Supply!

INCH/METRIC
.0005"/.01mm RESOLUTION

Item#	Range	Accuracy	Price (E)
4300-0138	8"/200mm	.0015"/.03mm	181.46
4300-0146	24"/600mm	.0025"/0.05mm	381.04

Replacement Battery (Item #4102-0032)....\$3.32

Replacement Clamp & Scriber
(see Page 67 for Dimensions)

Scriber Item#	Price (F)	Clamp Item#	Price (F)
4300-0016	26.73	4300-0151	20.68

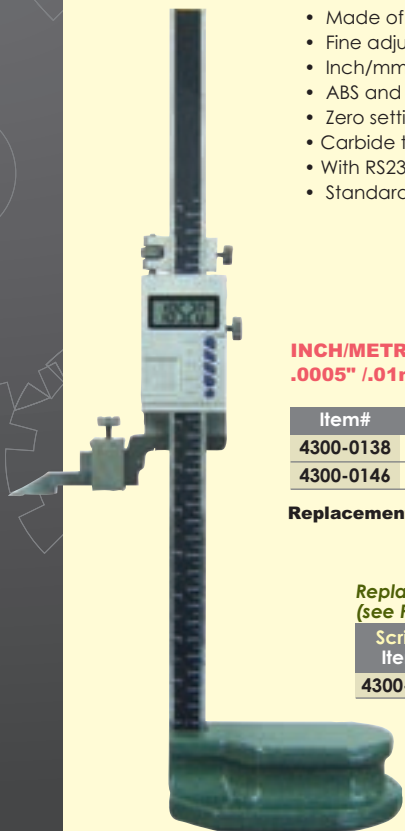

DIGITAL ELECTRONIC HEIGHT GAGES

- Large display screen
- Hardened and ground stainless steel frame
- Preset memorizing function
- Cast iron base
- True inch/metric conversion.
- Button battery SR 44, 1.5 V

INCH/METRIC
.0005"/.01mm RESOLUTION

0~12" Range
4300-0112
\$271.30



* Limited Supply

Item#	Range	Accuracy	Price (E)
4300-0112*	12"/300mm	.0020"/0.04mm	271.30
4300-0120*	20"/500mm	.0022"/0.05mm	278.48
4300-0124	24"/600mm	.0025"/0.05mm	598.90

Replacement Battery (Item #4102-0030)..\$3.19

Replacement Scriber(see Page 67 for Dimensions)

Scriber Item#	Price (F)
4300-0126	26.73

DIGITAL ELECTRONIC HEIGHT GAGES

PRECISION MEASURING TOOLS

Dasqua®

BUILT-IN BLUETOOTH ABSOLUTE HEAVY DUTY DIGITAL ELECTRONIC HEIGHT GAUGE

- IP65
COOLANT & FLUID
RESISTANT
- Data
output
- BLUETOOTH
TRANSMITTER
- Battery
+
CR2032
- mm
/inch



- The new generation measuring serie with Built-in Bluetooth transmission.
- Absolute function.
- Heavy duty main beam and base.
- Direct inch/metric conversion.
- Large, easy-to-read digital display.
- Carbide tipped scriber for sharp, clean lines.
- Class A for electrostatic discharge.
- Zeros-setting at any position.

Item#	Range	Resolution	Accuracy	Price (F)
3230-1110*	0-24"/0-600mm	.0005"/.01mm	.002"/.05mm	612.07

* Limited Supply

With Wireless Transmitter

Item#	Range	Resolution	Accuracy	Price (F)
3230-4705	0-12"/0-300mm	.0005"/.01mm	.001"/.03mm	557.00
3230-4710	0-24"/0-600mm	.0005"/.01mm	.002"/.05mm	612.00

Replacement Clamp & Scriber (see Page 67 for Dimensions)
Replacement Battery (Item #4102-0030)....\$3.19

DIGITAL ELECTRONIC HEIGHT GAGES WITH WHEEL

- Large control panel.
- Beam is made of stainless steel.
- Fine adjustment.
- Inch/mm conversion.
- Zero setting.
- Carbide tipped scriber.
- Power: 1.5V SR44 battery.
- Ergonomic heavy duty base.

**INCH/METRIC
.0005"/.01MM
RESOLUTION**



Item#	Range	Accuracy	Price (E)
4300-0161	12"/300mm	+/- .002"/.04mm	438.08
4300-0162*	20"/500mm	+/- .002"/.05mm	384.12
4300-0163	24"/600mm	+/- .002"/.05mm	649.67

Replacement Battery (Item #4102-0030)....\$3.19

Dasqua®

DIGITAL ELECTRONIC DOUBLE-BEAM HEIGHT GAGE

- Heavy duty construction for industry use.
- Large LCD display.
- Zero-setting at any position.
- Double stainless beams assure high accuracy.
- Base is hardened, ground and lapped for maximum flatness.
- Carbide tipped scriber for sharp, clean lines.
- On/Off switch ABS/INC switchable and hold function.
- Micro-adjustable wheel for easy head displacement/precision positioning.



**INCH/METRIC
.0005"/.01MM
GRADUATION**

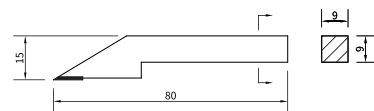

Replacement Scriber (Item# 3130-4115)....\$27.13

Item#	Range	Accuracy	Price (F)
3230-8105	0-12"/0-300mm	+/- 0.002"/0.04mm	519.38

SURFACE GAGES & GRANITE PLATES

STEEL SURFACE GAGES

- Fine adjustment.
- Retractable pins in base for working on flat surfaces.
- Bottom V-groove ground for cylindrical works.
- Spindle can be adjustable to any angle above or below base.
- Scriber head hardened has spring control.
- Base fully hardened throughout.
- Two posts included.



Item#	Post Length	Price (F)
4401-2012	4 & 7"	40.75
4401-2014	9 & 12"	49.64

HDF-TYPE SURFACE GAGE

- There are two frictional held gage pins in the base, which can be pushed down and used against the edge of a surface plate or T-slot for linear works.
- One handed fine adjustment.
- Steel base hardened and ground on one end and bottom surface.
- Bottom V-groove for cylindrical works.
- V groove on the front end which allows the spindle to adjust to any angle above or below the base
- Scriber head hardened.



Post Length
12 & 18" Included

4401-2018
\$4785
(F)

SURFACE GAGE - Fine Tune On Top

- Knob on top of surface gage for easy adjustment.
- One handed fine adjustment.
- Steel base hardened and ground with magnet On/Off switch.
- Scriber head hardened.

Limited Supply!



Post Length 12"

4401-2020
\$9310
(F)

BLACK GRANITE SURFACE PLATES

- Surface plates are checked by auto-collimator for overall accuracy assurance.
- Granite surface plates meet or exceed Federal Specifications GGG-P-463C.

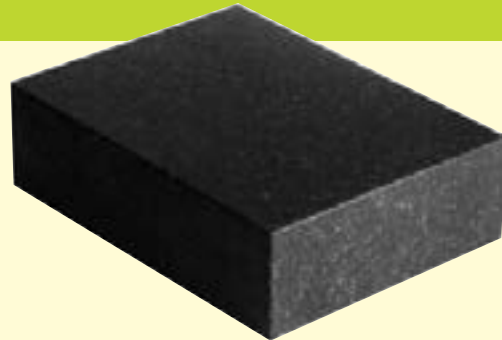

INCLUDES CERTIFICATE OF INSPECTION. NOT NIST TRACEABLE

Grade: A • Ledge: 0

Item#	Size	Accuracy	Wt. (lbs)	Price (1)
4401-1812	18 x 12 x 3"	±.000050"	80	121.73
4401-2418	24 x 18 x 3"	±.000075"	150	235.95

Item#	Size	Accuracy	Wt. (lbs)	Price (1)
4401-3624	36 x 24 x 4"	±.0001"	495	553.49
4401-4836	48 x 36 x 6"	±.0002"	1200	1,369.87

Please let us know if you require calibration

Grade: B • Ledge: 0

Item#	Size	Accuracy	Wt. (lbs)	Price (1)
4401-1596	6 x 6 x 2"	±.0001"	10	46.73
4401-1597	6 x 8 x 2"	±.0001"	12	49.61
4401-1598	12 x 8 x 2"	±.0001"	20	55.44
4401-1599	12 x 9 x 2"	±.0001"	26	59.61
4401-0011	12 x 9 x 3"	±.0001"	40	73.15

Item#	Size	Accuracy	Wt. (lbs)	Price (1)
4401-0012	18 x 12 x 3"	±.0001"	80	96.60
4401-0013	24 x 18 x 3"	±.00015"	150	191.22
4401-0014	36 x 24 x 4"	±.0002"	495	536.31
4401-1604	48 x 36 x 6"	±.0004"	1200	1,238.20
4401-1607	48 x 72 x 6"	±.0004"	2480	3,769.70

GRANITE SURFACE PLATE STANDS

- Overall working height: 36"
- Made of heavy-gauge steel with durable baked enamel finish.
- Assembly required.
- Stand comes with leveling screws



For 0 Ledge

Item#	For Plate Size	Wt. (lbs)	Price (H)
4401-1301	24 x 18"	64	235.11
4401-1401	36 x 24"	82	306.39
4401-1602	48 x 36"	126	529.63
4401-1608	48 x 72"	225	870.30

GAGE BLOCK SETS & ACCESSORIES

Pro-Series RECTANGULAR STEEL GAGE BLOCK SETS

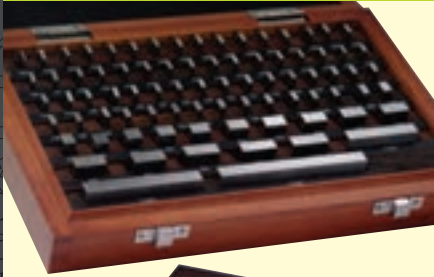

- Meets or exceeds Federal GGG-G-15C.
- Surface hardness: HRC 64
- Made of the highest quality tool steel.
- Complete with manufacturer's calibration or certificate.
- With fitted wooden case with sizes labeled.



81pc Set, Grade AS-2
4101-0022
\$20480
(E)

Offering N.I.S.T. Traceable Calibration Conforms to

- MIL-STD 45662A
- GGG-G-15C
- ISO/IEC 17025 Accredited
- ISO 9000, 10012-1
- ANSI-NCSL Z540-1
- ISO GUIDE 25 Certified



ACCURACY

Grade AS-0= Grade 2(A1) : +4/-2 millionth
Grade AS-1= Grade 3(B1) : +8/-4 millionth
Grade AS-2= Grade B: ± 50 millionth

Item#	No. of Blocks	Grade	Price (E)	Blocks Included in All Sets
4101-0001	81pc	AS-0	650.09	9 Blocks: .1001" thru .1009" step of .0001"
4101-0021	81pc	AS-1	343.68	49 Blocks: .101" thru .149" step of .001"
4101-0022	81pc	AS-2	204.80	19 Blocks: .050" thru .950" step of .050"
NIST Calibration Certificate 81pc/Set			CALL	4 Blocks: 1.000" thru 4.000" step of 1.000"
4101-0002	36pc	AS-0	353.83	10 Blocks: .1000" thru .1009" step of .0001"
4101-0004	36pc	AS-2	119.68	9 Blocks: .101" thru .109" step of .001"
NIST Calibration Certificate 36pc/Set			CALL	9 Blocks: .110" thru .190" step of .010"
				8 Blocks: .050, .200, .300, .400, .500, 1.0, 2.0 & 4.0"

Dasqua® 81PC RECTANGULAR CALIBRATION GAGE BLOCK SETS



- Precision ground, mirror polish, heat treatment and cryogenic treatment for all measuring surfaces.
- Provided with fitted Aluminum case
- Stable dimensions with high accuracy, low surface roughness, high wringing force.
- Used to calibrate and adjust measuring equipment precision instruments, machine and fixtures and to standardize the measurement of length in manufacturing.
- Made of premium hardened steel. High-carbon, high-chrome steel provides high hardness HRC63 and wear resistance.
- Stable dimensions with high accuracy, low surface roughness, high wringing force.
- Strictly made in accordance with DIN ISO 3650.
- Precision ground, mirror polish, heat treatment and cryogenic treatment of all measuring surfaces.
- Certificate of accuracy is furnished.
- Edges are slightly bevelled for protection.
- Each block is serialized and marked for easy identification.

ACCURACY

Length Range (L)	AS 0 (in.)	AS 1 (in.)
L<0.05"	4	6
0.05<L-0.4"	4	6
0.45<L-1"	4	6
1<L-2"	4	6
2<L-3"	4	6
3<L-4"	5	8

Grade 0: mainly used in calibration laboratory by specialized inspection staff, as reference standards for calibration of high precision measuring equipment and accuracy lower than 1/2 of accuracy of gage blocks.

Grade 1: mainly used in laboratory to inspect htgh precision workpieces, gage blocks and measuring equipment.

Item#	Grade	Pcs/Set	Nominal Size	Steps	Pieces	Price (F)
6111-3281	AS 1	81	0.05"	/	1	430.74
			0.1000-0.1009"	0.0001"	10	
			0.101-0.149"	0.001"	49	
6110-3281	AS 0		0.150-0.950"	0.05"	17	648.00
			1.000-4.000"	1.000"	4	

RECTANGULAR GAGE BLOCK ACCESSORIES

- Made with gage block accuracy.
- Base block's mounting surface lapped flat and parallel with base.

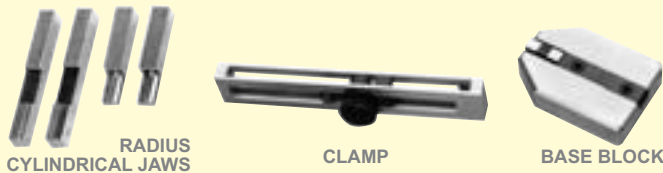

Item#	Description	Price (E)
4101-0601	Base Block 4x2.750x1/7"	209.44
4101-0606	Clamp 4" capacity	51.55
4101-0607	Clamp 8" capacity	68.06
4101-0610	Radius 0.0787" Cylindrical Jaws (pair)	117.94
4101-0611	Radius 0.200" Cylindrical Jaws (pair)	100.50
4101-0612	Radius 0.750" Cylindrical Jaws (pair)	98.23

WOOD CASE FOR 81PC RECTANGULAR GAGE BLOCK SETS

- Fits any grade.
- Well made wood case with high quality hardware.
- Insert is perfect fit each block.
- Clear sizes labeled.



SIZES LABELED

9 Blocks	.1001" thru .1009" step of .0001"
49 Blocks	.101" thru .149" step of .001"
19 Blocks	.050" thru .950" step of .050"
4 Blocks	1.000" thru 4.000" step of 1.000"
10 Blocks	.1000" thru .1009" step of .0001"
9 Blocks	.101" thru .109" step of .001"
9 Blocks	.110" thru .190" step of .010"
8 Blocks	.050, .200, .300, .400, .500, 1.0, 2.0 & 4.0"

CASE ONLY
4101-0099
\$3713
(F)

METRIC RECTANGULAR STEEL GAGE BLOCK SETS

- Fitted case supplied.
- Meets or exceeds JS Standard.
- Furnished with manufacturer's calibration or certificate.
- Each block has a series no.
- Made of the highest quality tool steel.

Nominal Size (mm)	ACCURACY	
	JIS 1 Tolerances in Microns (0.001mm)	JIS 2
10 or Less	±0.20	±0.45
10~25	±0.30	±0.60
25~50	±0.40	±0.80
50~75	±0.50	±1.00
75~100	±0.60	±1.20

Offering N.I.S.T. Traceable Calibration Conforms to

- MIL-STD 45662A
- GGG-G-15C
- ISO/IEC 17025 Accredited
- ISO 9000, 10012-1
- ANSI-NCSL Z540-1
- ISO GUIDE 25 Certified



Item#	No. of Blocks	Grade	Price (E)	Blocks Included in All Sets
4101-1041	87pc	JIS 1	567.18	9Blocks: 1.001~1.009 Step of 0.001mm
4101-1042	87pc	JIS 2	322.56	49Blocks: 1.01~1.49 Step of 0.01mm
NIST Calibration Certificate 87pc/Set			CALL	19Blocks: 0.5~9.5 Step of 0.5mm 10Blocks: 10~100 Step of 25mm

81PC STEEL SQUARE GAGE BLOCK SETS

- Each block with center hole threaded.
- Meet or exceeds U.S. Federal specification GGG - G - 15C.
- Complete with manufacturer's calibration or certification.
- Made of the highest quality tool steel.
- Surface Hardness: HRC 64
- With sturdy fitted wooden case.
- With center hole.

Offering N.I.S.T. Traceable Calibration Conforms to

- MIL-STD 45662A
- GGG-G-15C
- ISO/IEC 17025 Accredited
- ISO 9000, 10012-1
- ANSI-NCSL Z540-1
- ISO GUIDE 25 Certified

ACCURACY

Grade AS-0= Grade 2(A): +4/-2 millionth
Grade AS-1= Grade 3(B): +8/-4 millionth
Grade AS-2= Grade B: ± 50 millionth



81pc Set Grade AS-2 (Grade B)

4101-0052

\$784.52 (E)

Item#	Grade	Price (E)	Blocks Included in All Sets
4101-0051	AS-0	2,141.41	9 Blocks: .1001~.1009" step of .0001"
4101-0005	AS-1	1,773.20	49 Blocks: .101~.149" step of .001"
4101-0052	AS-2	784.52	19 Blocks: .050~.950" step of .050"
NIST Calibration Certificate 81pc/Set			CALL
			4 Blocks: 1.000~4.000" step of 1.000"

INDIVIDUAL RECTANGULAR GAGE BLOCKS

Offering N.I.S.T. Traceable Calibration Conforms to

- MIL-STD 45662A
- GGG-G-15C
- ISO/IEC 17025 Accredited
- ISO 9000, 10012-1
- ANSI-NCSL Z540-1
- ISO GUIDE 25 Certified

- Grade AS-0 (Grade 2(A))
- Each block is supplied with a manufacturer's certificate



Tolerance

0-1".....	+0.000004/-0.000002"
2".....	+0.000008/-0.000004"
3".....	+0.000010/-0.000005"
4".....	+0.000012/-0.000006"

Item#	Size (Inch)	Price (F)
4101-0701	0.0500	32.45
4101-0702	0.1000	26.03
4101-0703	0.1001	26.03
4101-0704	0.1002	26.03
4101-0705	0.1003	26.03
4101-0706	0.1004	26.03
4101-0707	0.1005	26.03
4101-0708	0.1006	26.03
4101-0709	0.1007	26.03
4101-0710	0.1008	26.03
4101-0711	0.1009	26.03
4101-0712	0.101	26.03
4101-0713	0.102	26.03
4101-0714	0.103	26.03
4101-0715	0.104	26.03
4101-0716	0.105	26.03
4101-0717	0.106	26.03
4101-0718	0.107	26.03
4101-0719	0.108	26.03
4101-0720	0.109	26.03
4101-0721	0.110	26.03
4101-0722	0.111	26.03
4101-0723	0.112	26.03
4101-0724	0.113	26.03
4101-0725	0.114	26.03
4101-0726	0.115	26.03
4101-0727	0.116	26.03
4101-0728	0.117	26.03
4101-0729	0.118	26.03
4101-0730	0.119	26.03
4101-0731	0.120	26.03
4101-0732	0.121	26.03
4101-0733	0.122	26.03
4101-0734	0.123	26.03
4101-0735	0.124	26.03
4101-0736	0.125	26.03
4101-0737	0.126	26.03
4101-0738	0.127	26.03

Item#	Size (Inch)	Price (F)
4101-0739	0.128	26.03
4101-0740	0.129	26.03
4101-0741	0.130	26.03
4101-0742	0.131	26.03
4101-0743	0.132	26.03
4101-0744	0.133	26.03
4101-0745	0.134	26.03
4101-0746	0.135	26.03
4101-0747	0.136	26.03
4101-0748	0.137	26.03
4101-0749	0.138	26.03
4101-0750	0.139	26.03
4101-0751	0.140	26.03
4101-0752	0.141	26.03
4101-0753	0.142	26.03
4101-0754	0.143	26.03
4101-0755	0.144	26.03
4101-0756	0.145	26.03
4101-0757	0.146	26.03
4101-0758	0.147	26.03
4101-0759	0.148	26.03
4101-0760	0.149	26.03
4101-0761	0.150	26.03
4101-0766	0.200	32.54
4101-0767	0.250	32.54
4101-0768	0.300	32.54
4101-0769	0.350	32.54
4101-0770	0.400	32.54
4101-0771	0.450	32.54
4101-0772	0.500	32.54
4101-0773	0.550	32.54
4101-0774	0.600	32.54
4101-0775	0.650	32.54
4101-0776	0.700	32.54
4101-0777	0.750	35.01
4101-0778	0.800	35.01
4101-0779	0.850	35.01
4101-0780	0.900	35.01
4101-0781	0.950	35.01
4101-0782	1.000	41.38
4101-0783	2.000	54.46
4101-0784	3.000	69.89
4101-0785	4.000	95.90

INDIVIDUAL SQUARE GAGE BLOCKS

- Grade AS-0 (Grade 2(A)) : +4/-2 millionth
- Each block is supplied with a manufacturer's certificate

Tolerance	
0-1".....	+0.000004/-0.000002"
2".....	+0.000008/-0.000004"
3".....	+0.000010/-0.000005"
4".....	+0.000012/-0.000006"

Limited Supply!



EACH BLOCK HAS 1/4" DIA. HOLE

Item#	Size (Inch)	Price (F)	Item#	Size (Inch)	Price (F)	Item#	Size (Inch)	Price (F)
4101-0903	.1001	41.40	4101-0930	.119	41.40	4101-0956	.145	41.40
4101-0904	.1002	41.40	4101-0931	.120	41.40	4101-0957	.146	41.40
4101-0905	.1003	41.40	4101-0932	.121	41.40	4101-0958	.147	41.40
4101-0906	.1004	41.40	4101-0933	.122	41.40	4101-0959	.148	41.40
4101-0907	.1005	41.40	4101-0934	.123	41.40	4101-0960	.149	41.40
4101-0908	.1006	41.40	4101-0935	.124	41.40	4101-0961	.150	28.18
4101-0909	.1007	41.40	4101-0936	.125	41.40	4101-0966	.200	45.80
4101-0910	.1008	41.40	4101-0937	.126	40.99	4101-0967	.250	45.80
4101-0914	.1009	41.40	4101-0938	.127	41.40	4101-0968	.300	45.80
4101-0912	.101	41.40	4101-0939	.128	25.30	4101-0969	.350	45.80
4101-0913	.102	25.30	4101-0940	.129	41.40	4101-0970	.400	45.80
4101-0914	.103	41.40	4101-0941	.130	41.40	4101-0971	.450	56.05
4101-0915	.104	41.40	4101-0942	.131	41.40	4101-0972	.500	56.05
4101-0916	.105	41.40	4101-0943	.132	41.40	4101-0973	.550	56.05
4101-0917	.106	41.40	4101-0944	.133	41.40	4101-0974	.600	56.05
4101-0918	.107	41.40	4101-0945	.134	41.40	4101-0975	.650	56.05
4101-0919	.108	41.40	4101-0946	.135	41.40	4101-0977	.750	56.05
4101-0920	.109	41.40	4101-0947	.136	41.40	4101-0978	.800	56.05
4101-0921	.110	41.40	4101-0948	.137	41.40	4101-0979	.850	56.05
4101-0922	.111	41.40	4101-0949	.138	41.40	4101-0980	.900	56.05
4101-0923	.112	41.40	4101-0950	.139	41.40	4101-0981	.950	56.05
4101-0924	.113	40.99	4101-0951	.140	41.40	4101-0982	1.000	65.25
4101-0925	.114	41.40	4101-0952	.141	41.40	4101-0983	2.000	97.66
4101-0926	.115	41.40	4101-0953	.142	41.40	4101-0984	3.000	130.02
4101-0927	.116	41.40	4101-0954	.143	41.40	4101-0985	4.000	178.88
4101-0929	.118	41.40	4101-0955	.144	41.40			

1-2-3 BLOCKS

PRECISION 1-2-3 BLOCKS SETS

- Heat treated and case hardened to HRC 55 to 60.
- Hardened and precision ground on all 6 sides of each block.
- Accuracy with squareness on all sides within .0002" per inch.
- 23 holes consists of 5 tapped holes (3/8" - 16 for 1-2-3) for clamping and 18 untapped holes drilled.
- Cross drilling design gives minimum weight and maximum strength.
- Dimensions: 1-2-3 is 1 x 2 x 3"

1-2-3 BLOCK SET
3402-0005
\$2306
 (F)

TiN Coated
1-2-3 BLOCK SET
3402-0905
\$3743
 (F)

**MATCHED PAIRS
 AND SOLD AS PAIR**



5 Tapped Holes & 18 Untapped Through Holes

Dasqua® 1-2-3 BLOCKS

- Supplied with durable fitted ABS case.
- Product Dimensions: 1" x 2" x 3".
- Heat treated and case hardened to HRC 58-62.
- Hardened and precision ground on all 6 sides of each block.
- 23 holes consists of 5 tapped holes that are 3/8-16 for clamping and 18 untapped holes
- Sold in pairs.
- Tolerance of size ±.0002", Parallelism 0.0002", Height of pair 0.0002".
- Cross drilling design gives minimum weight and maximum strength.



Item#	Size	Squareness	Price (F)
8407-0005	1 x 2 x 3"	0.0001"/1"	45.40
8407-0010	1 x 2 x 3"	0.0003"/1"	30.24

ULTRA PRECISION 8PC 1-2-3 BLOCKS & SCREWS SET

- Hardened and precision ground on all 6 sides of each block.
- Accuracy with Squareness on all sides within .0001 per inch.
- 23 holes consist of 5 (3/8"-16) tapped holes for clamping and 18 untapped holes drilled.
- Supplied with fitted case.

5 TAPPED HOLES & 18 UNTAPPED THROUGH HOLES

8 PC SET
3402-0055
\$3983
 (E)

MATCHED PAIRS

INCLUDES

Matched pair of 1-2-3 blocks with 23 holes,
 5pc of 3/8 - 16 Socket Screws, Hex key



1-2-3 BLOCKS & 2-4-6 BLOCKS

ULTRA PRECISION 1-2-3 BLOCKS WITH NO HOLE

- Hardened to RC 58-60 and ground to surface finish from 6 to 10 micron inches.
- Dimensions: 1 x 2 x 3 .

MATCHED PAIRS AND SOLD AS PAIR

3402-0058
\$2772
 (F)

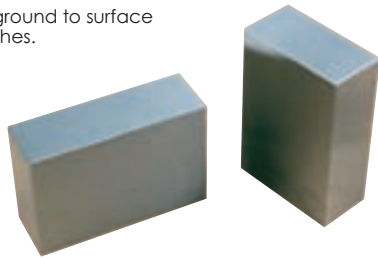

ULTRA PRECISION 1-2-3 BLOCKS WITH ONE HOLE

- For precision grinding, layout, etc.
- Drilled Hole Size: .500 ~.501
- Accuracy with squareness on all sides within .0001 per inch.
- Hardened to RC 58-60 and ground to surface finish from 6 to 10 micron inches.
- Dimensions: 1 x 2 x 3"

3402-0054
\$3781
 (F)

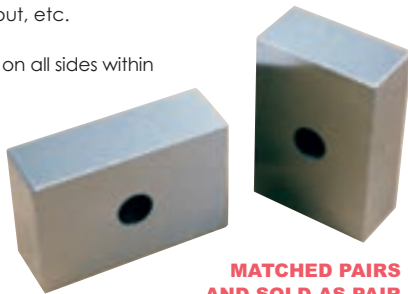

MATCHED PAIRS AND SOLD AS PAIR

ULTRA PRECISION 1-2-3 BLOCKS WITH 11 HOLES



5 TAPPED HOLES & 6 UNTAPPED THROUGH HOLES

- Hardened and precision ground on all 6 sides of each block.
- Accuracy with squareness on all sides within .0001 per inch.
- Consists of 5 tapped holes 5/16 - 18 for clamping and 6 untapped holes drilled through.
- Dimensions: 1 x 2 x 3".

MATCHED PAIRS AND SOLD AS PAIR

3402-0051
\$4029
 (F)

PRECISION 2-3-4 BLOCKS SET

- Hardened and precision ground on all 6 sides of each block.
- Accuracy with squareness on all sides within .0001" per inch.
- 23 holes consist of 5 (3/8"-16) tapped holes for clamping and 18 untapped holes drilled.
- Dimensions: 2 x 3 X 4".

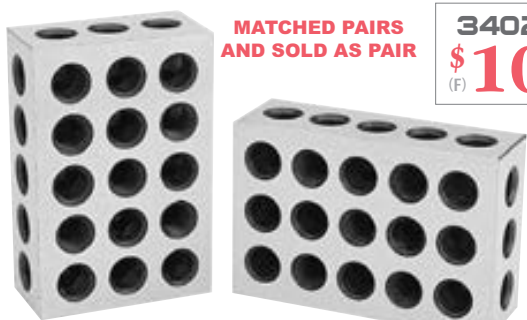

MATCHED PAIRS AND SOLD AS PAIR

3402-0906
\$10238
 (F)

5 TAPPED HOLES & 18 UNTAPPED THROUGH HOLES

PRECISION 2-4-6 BLOCKS SET

- Heat treated and case hardened to HRC 55 to 60.
- Hardened and precision ground on all 6 sides of each block.
- Accuracy with squareness on all sides within .0002" per inch.
- 23 holes consists of 5 tapped holes (5/8"-11 for 2-4-6) for clamping and 18 untapped holes drilled.
- Cross drilling design gives minimum weight and maximum strength.
- Dimensions: 2-4-6 is 2 x 4 x 6"

MATCHED PAIRS AND SOLD AS PAIR

2-4-6 BLOCK SET
3402-0510
\$14093
 (F)

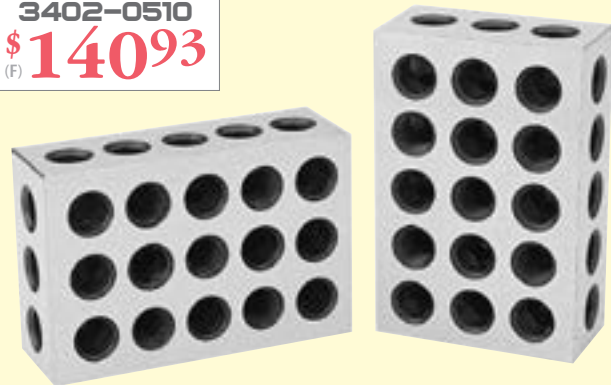

5 TAPPED HOLES & 18 UNTAPPED THROUGH HOLES

36PC SPACE BLOCK SET

- Four connecting screws 1/4"-28 are included to make any length desired.
- ID is threaded 1/4"-28.
- Meets or exceeds federal specifications.
- Work surface hardened to 57-60 RC.
- Made of precision tool steel.
- Individually marked.
- Complete in fitted case.



ACCURACY: ±0.0001"

Set Includes:

- 9 Blocks: .101 to .109 by .001"
- 15 Blocks: .050 to .190 by .010"
- 9 Blocks: .200 to 1.000 by .100"
- 2 Blocks: .0625" and .125"
- 1 Extra Block: 1.000"

3101-0003
\$9935
 (E)

SINE BARS

- For angles set up by using Sine Bar with 1-2-3 Blocks or Gage Block.
- Parallelism: 0.0004".
- Working face accuracy 0.00003"/ per inch.
- Rolls center distance accuracy 0.0002".
- Flange on the end for the resting of workpiece.

5x1"(LxW)
3402-1205
\$6935
 (F)

2.5 x1"(LxW)
3402-1203
\$5648
 (F)



1-2-3 BLOCK NOT INCLUDED

PRECISION MEASURING TOOLS

PARALLELS & SETS

10 PAIR 1/8" PRECISION PARALLEL SETS

- Made from fine quality tool steel stress relieved against distortion, precision ground and hardened.
- Complete with fitted durable plastic or wooden case.
- 2 holes in each parallel.

1/8X6" SET
3900-3010
\$5893
 (F)
 PLASTIC CASE



3900-3010 Shown



DIMENSIONS	
Thick	Ht. x Long
1/8	x 1/2 x X"
1/8	x 5/8 x X"
1/8	x 3/4 x X"
1/8	x 7/8 x X"
1/8	x 1 x X"
1/8	x 1-1/8 x X"
1/8	x 1-1/4 x X"
1/8	x 1-3/8 x X"
1/8	x 1-1/2 x X"
1/8	x 1-5/8 x X"

- TOLERANCE: PARALLEL TO 0.0003 ON 2 SIDES, TOP AND BOTTOM.
- DIMENSIONS: WITHIN 0.001" ALLOWANCE.



3900-3012 Shown



1/8X3" SET
3900-3012
\$4084
 (F)
 WOODEN CASE

1/8X4" SET
3900-3002
\$5910
 (F)
 WOODEN CASE

1/8X5" SET
3900-3013
\$5910
 (F)
 WOODEN CASE

PRECISION MEASURING TOOLS

Dasqua® 1/8" PRECISION PARALLEL SET WITH ALUMINUM CASE

- Made of premium alloy steel, hardened, stress-relieved, precision ground, used in pairs.
- With high perpendicularity, parallelism, dimension accuracy, convenient to use and maintain.
- Easy to operate during the drilling, milling, assembling work, convenient to clamp workpiece, and provide a reliable and accurate position for the workpiece.
- Accuracy: Height ± 0.0004 ", thickness ± 0.0004 ", use in pairs: ± 0.0004 " (height/thickness).
- Edges are slightly beveled.
- Superior surface finish: Ra 0.4um/16uin, high hardness: HRC56-61, long service life.
- Matched pairs are marked with sizes.
- Fitted aluminum case.



Item#	Set	Length x Thickness	Height	Price (F)
8204-0015	10 Pairs	1/8 x 6"	1/2", 5/8", 3/4", 7/8", 1", 1-1/8", 1-1/4", 1-3/8", 1-1/2", 1-5/8"	79.92

Dasqua® PREMIUM MAGNETIC PARALLEL SET WITH HANDLE



- Higher accuracy from Dasqua.
- Height tolerance: ± 0.005 mm, Width tolerance: 0.01mm.
- Hardness: 55-60HRC.
- Newly designed embed magnets leaving your hands for clamping and setting up, reduce the clamping time significantly.

Patented Design for Easy Installation and Disassembly

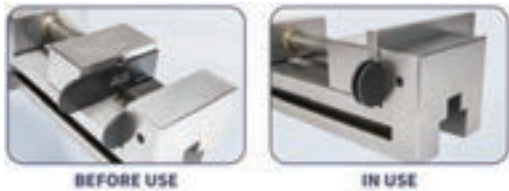

Item#	Set (Pairs)	Length	Width	Thickness	Price (F)
1801-0115	5	5"/150mm	1"/25mm, 1.37"/35mm, 1.57"/40mm, 1.77"/45mm, 1.85"/47mm	0.1"/2.5mm	123.08

PRECISION PARALLEL SETS

- Made from fine quality tool steel stress relieved against distortion, precision ground and hardened.
- These precision parallels are recommended for layout work, standards and set-up.
- The holes are designed for easier handling and set-ups.
- Hardness: Case hardened RC 55 to 62 on 2 sides, top and bottom only.
- Complete with fitted durable plastic case.
- TOLERANCE: PARALLEL TO 0.0003 ON 2 SIDES, TOP AND BOTTOM.
- DIMENSIONS: WITHIN 0.001" ALLOWANCE.



3/16", 4 PAIR SET
3900-3004
\$ **4886**
(F)

DIMENSIONS

3/16 x 1 x 6"
3/16 x 1-1/4 x 6"
3/16 x 1-1/2 x 6"
3/16 x 1-3/4 x 6"

DIMENSIONS

1/4 x 3/4 x 6"
1/4 x 7/8 x 6"
1/4 x 1 x 6"
1/4 x 1-1/8 x 6"
1/4 x 1-1/4 x 6"
1/4 x 1-3/8 x 6"
1/4 x 1-1/2 x 6"
1/4 x 1-5/8 x 6"
1/4 x 1-3/4 x 6"

1/4", 9 PAIR SET
3900-3009
\$ **10739**
(F)

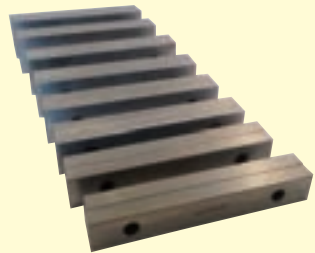
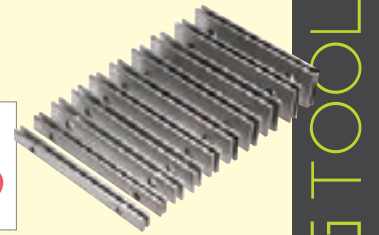

1/2", 8 PAIR SET
3900-3008
\$ **13905**
(F)

DIMENSIONS

1/2 x 7/8 x 6"
1/2 x 1 x 6"
1/2 x 1-1/8 x 6"
1/2 x 1-1/4 x 6"
1/2 x 1-3/8 x 6"
1/2 x 1-1/2 x 6"
1/2 x 1-5/8 x 6"
1/2 x 1-3/4 x 6"

DIMENSIONS

1/2 x 1 x 6"
1/2 x 1-1/4 x 6"
1/2 x 1-1/2 x 6"
1/2 x 1-3/4 x 6"

Item 3900-3014 Shown
1/2", 4 PAIR SET
3900-3014
\$ **6111**
(F)

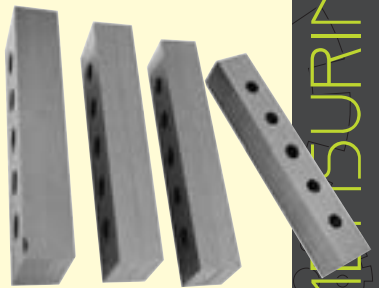

INDIVIDUAL PRECISION PARALLELS

- Made from fine quality tool steel stress relieved against distortion, precision ground and hardened.
- 2 Holes in each parallel, are designed for easier handling and set-ups.
- Tolerance: Parallel to 0.0003 on 2 sides, top and bottom.
- Dimensions: Within 0001" allowance.



SOLD BY PAIR

Item#	DIMENSION (ThinkHt.xLong)	Price (F)
3900-3061	1/8 x 1/2 x 6"	7.30
3900-3062	1/8 x 5/8 x 6"	7.30
3900-3063	1/8 x 3/4 x 6"	7.30
3900-3064	1/8 x 7/8 x 6"	7.30
3900-3065	1/8 x 1 x 6"	7.30
3900-3066	1/8 x 1-1/8 x 6"	7.30
3900-3067	1/8 x 1-1/4 x 6"	7.30
3900-3068	1/8 x 1-3/8 x 6"	7.30

Item#	DIMENSION (ThinkHt.xLong)	Price (F)
3900-3069	1/8 x 1-1/2 x 6"	7.30
3900-3070	1/8 x 1-5/8 x 6"	7.30
3900-3075	1/4 x 3/4 x 6"	16.78
3900-3077	1/4 x 1 x 6"	16.78
3900-3079	1/4 x 1-1/4 x 6"	16.78
3900-3085	1/2 x 1 x 6"	17.26
3900-3086	1/2 x 1-1/8 x 6"	17.26
3900-3087	1/2 x 1-1/4 x 6"	17.26

ULTRA PRECISION INSPECTION PARALLEL

- Parallels are furnished by pair.
- Made of high grade tool steel, stabilized and thoroughly hardened to HRC 58.
- Surface finish to 16 microninches.
- High precision - 4 faces accuracy within .00015" per 6 inches

PRICED IN PAIR



Item#	Size	Weight (lbs.)	Price (E)
3900-3049	1 x 2 x 12"	14	99.78

PARALLELS & ANGLE BLOCKS

9PC UNIVERSAL ANGLE BLOCK SET

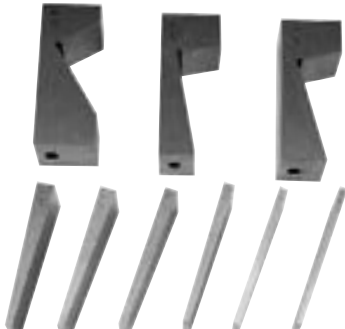

- HRC 45 to 50 heat treatment.
- Angle Accuracy: $\pm 5'$
- Combination V-block and angle plate for rapid, easy setting.
- No sine vise, sine plate, angle vise, chart or gage block needed.

3402-0018
\$11713 (E)

Set Includes
V-Blocks: 10, 15, 30°
Angle plates: 0.5, 1, 2, 3, 4, 5°

BLOCK SIZE: 2.75 L x 1.18 W

17PC PRECISION ANGLE BLOCK SET

- Get quick setups for fringing various angles from 1/4 to 45°
- Hardened steel
- With fitted case

ACCURACY: .0003"

17 PC SET
3402-0019
\$11688 (E)

BLOCK SIZE:
3" Length x 1/4" Thickness

INCLUDES
1/4, 1/2, 1, 2, 3, 4, 5, 10, 15, 20, 25, 30, 35, 40, & 45° and 2 riser blocks



6PC ADJUSTABLE PARALLEL SET

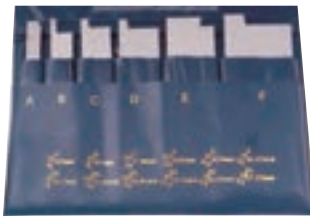

- Made of precision ground tool steel.
- Easily expanded to size in openings for quick reference measurements.
- Lock desired size by set screws provided.
- Exact size can be set with micrometer.
- Furnished in fitted plastic case with size range markings.

3900-0029
\$6530 (F)



DIMENSIONS

3/8~1/2", 1/2~11/16", 11/16~15/16", 15/16~1-5/16", 1-5/16~1-3/4", 1-3/4~2-1/4"

1/32" ULTRA THIN STEEL PARALLEL SET

- Length: 6"
- Parallelism: $\pm .0001"$
- Paired $\pm .0001"$ in height.
- Hardness: RC 50~55
- Thickness: 1/32"
- Made from fine quality tool steel, stress relieved against distortion, precision ground, hardened and blue finished.

20 PAIR SET
3900-3032
\$6408 (F)

DIMENSIONS

- 1/32 x 1/2 x 6"
- 1/32 x 9/16 x 6"
- 1/32 x 5/8 x 6"
- 1/32 x 11/16 x 6"
- 1/32 x 3/4 x 6"
- 1/32 x 13/16 x 6"
- 1/32 x 7/8 x 6"
- 1/32 x 15/16 x 6"
- 1/32 x 1 x 6"
- 1/32 x 1-1/16 x 6"
- 1/32 x 1-1/8 x 6"
- 1/32 x 1-3/16 x 6"
- 1/32 x 1-1/4 x 6"
- 1/32 x 1-5/16 x 6"
- 1/32 x 1-3/8 x 6"
- 1/32 x 1-7/16 x 6"
- 1/32 x 1-1/2 x 6"
- 1/32 x 1-9/16 x 6"
- 1/32 x 1-5/8 x 6"
- 1/32 x 1-11/16 x 6"



9 PAIR WAVY PARALLEL SET

- For use on: Precision clamping of parts in drilling, boring, milling, grinding, assembly work, etc.
- Can readily be used as elastic shims.
- Thin and fragile workpieces can be secured without damage by utilizing the spring pressure of these parallels.
- Made of high quality spring steel, hardened, stress relieved and precision ground.
- Fitted case.

3900-2909
\$6597 (F)

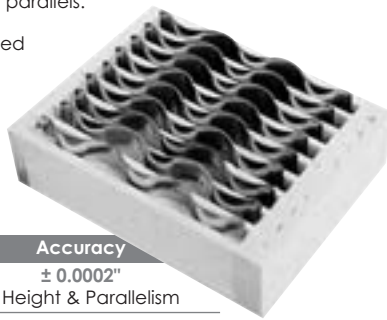

Range	Accuracy
1/2" ~ 1-1/2"	$\pm 0.0002"$
in 1/8" Height Increments in Height & Parallelism	

TANGENT BAR & ANGLE GAGE BLOCK SET

- Made of tool steel hardened and precision ground
- Tangent bar is micrometric

INCLUDES:
one Tangent Bar, one each of Angle Block 5, 10, 20, 30, 45°

6 PC SET
3402-0962
\$9540 (E)

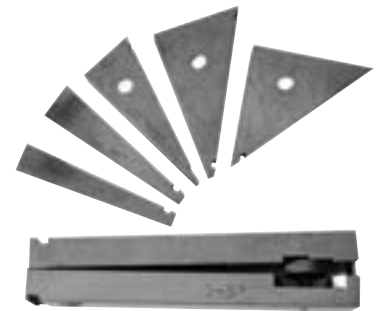

10PC ANGLE BLOCKS SET

BLOCK SIZE:
3" Length x 1/4" Thickness

- Simple, quick angle set ups.
- Manufactured of tool steel-hardened, stabilized and ground.
- Angle accuracy: 20'.
- Fitted case.

3402-0015
\$5895 (F)

INCLUDES
1, 2, 3, 4, 5, 10, 15, 20, 25, 30°



2PC SOLID ANGLE PLATE SET

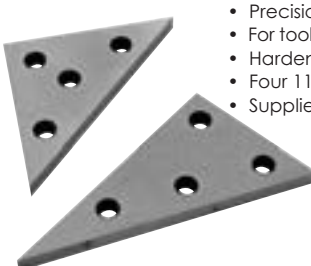

- Precision ground angles.
- For tooling setups, production and inspection.
- Hardened and ground steel.
- Four 11/32" holes.
- Supplied in fitted case.

3402-0016
\$2316 (F)

Includes
1pc- 45° x 45° x 90° (3 x 3 x 5/16)
1pc- 30° x 60° x 90° (2 x 3-3/8 x 5/16)

V-BLOCKS & CLAMPS SET

- 90° V groove accuracy are central, parallel and square with all surfaces within 0.0003".
- Case is hardened and ground.
- Clamps are included.

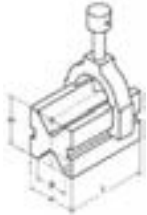

SUPPLIED IN MATCHED PAIR

Item#	Vee Capacity	Dimension (W x H x L)	Price (F)
3402-0952	1"	1-1/4 x 1-1/4 x 1-5/8"	60.08
3402-0951	1"	1-3/8 x 1-5/8 x 1-3/4"	66.76
3402-0953	1-1/2"	1-5/8 x 1-3/4 x 2-3/4"	79.97
3402-0954	1-1/2"	1-3/4 x 2-1/2 x 2-3/4"	109.20
3402-0955	2-1/8"	2-3/4 x 3-1/2 x 4-7/8"	227.48

Pro-Series V-BLOCK WITH CLAMP

- Made of hardened tool steel machined & ground in pairs to close tolerance.
- A versatile tool for Toolmakers & Machinists
- Clamps can easily slide in & are included.
- Both sides have different Vee sizes

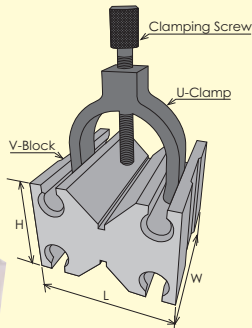
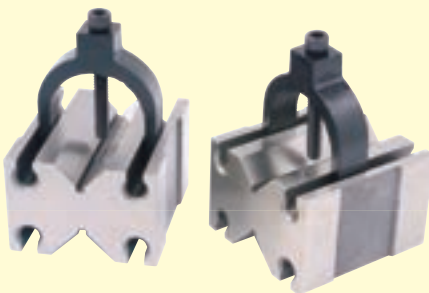

MADE IN TAIWAN

3402-0964
\$ **171.60**

SUPPLIED IN MATCHED PAIR

W	H	L	Small Vee	Large Vee	G.W.
2-1/2	1-3/4	2-3/4	1	1-3/16	6 lbs

Pro-Series Toolmaker's V-BLOCK SET

- Made of hardened tool steel precision machined & ground with high accuracy V groove. Tolerance 0.005mm.
- A versatile tool for Toolmakers & Machinists to check concentricity.
- Clamps can easily slide in & are included.
- Clamping range Ø3-20 mm.
- Height Deviation: 0.005mm
- Squareness: 0.005mm.



SOLD IN PAIR

Limited Supply!

MADE IN TAIWAN

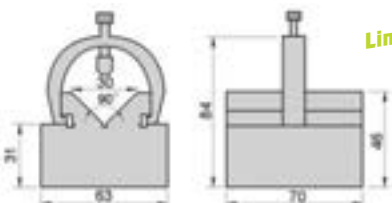

3402-0940
\$ **226.86**

Toolmaker's V-BLOCKS -Slot-In CLAMP

- Made of hardened & ground tool steel.
- Supplied in matched pair, machined to close tolerance.
- A versatile tool for Toolmakers & Machinists
- Clamps can easily slide in & are included.
- Both sides have different Vee sizes

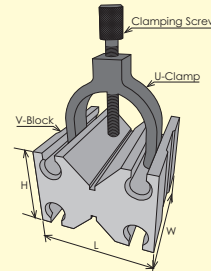

Item #	W	H	L	Small Vee	Large Vee	G.W.	Price (F)
3402-0968	2-1/2	1-3/4	2-3/4	1	1-3/16	6 lbs.	118.09
3402-0970	3-1/2	2-3/4	4-7/8	1.22	1.38	24 lbs.	264.69

MULTI-USE V-BLOCKS & CLAMPS SET

- Stepped groove construction.
- 90° V groove accuracy are central, parallel and square with all surfaces within 0.0003".
- Case is hardened and ground.
- Clamps are included.

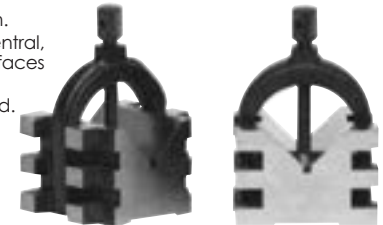

SUPPLIED IN MATCHED PAIR

Item#	Size (L x W x H)	Capacity		Price (F)
		Round	Square	
3402-0112	2.50 x 2.75 x 2.00"	2"	1-7/16"	109.26

Replacement Clamp (Item #3402-0115)..... \$18.62(F)

ULTRA PRECISION V-BLOCK & CLAMP SETS

- Guaranteed square parallel within .0002".
- Hardened & ground to RC 58-60.
- 90° Vee blocks.
- Supplied with bolts and clamps in wooden case.

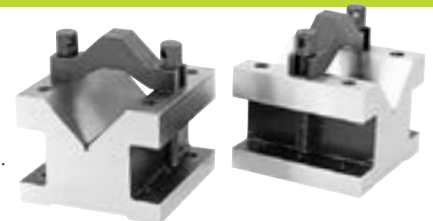

SUPPLIED IN MATCHED PAIR

Item#	Length	(Inch) Width	Height	Price (F)
3402-0001	1-3/8	1-3/8	1-3/16	62.37
3402-0002	2-3/8	2-3/8	2	96.53
3402-0003	4-1/8	4-1/8	3-1/16	188.82

TOOLMAKER'S V-BLOCKS & CLAMP

- Blocks have four 3/8"-26 tapped holes, two in the base and one on each side for attachment to an angle iron. The angle iron holding the block can then be attached to a lathe faceplate or held by a magnetic chuck.

- Versatile tool for grinding, milling or drilling
- A clearance hole for drilling or removing dowel pins is provided in the block
- Blocks are hardened and precision ground
- Side screw supports the block and prevents tilting.



1-5/16" CAPACITY
3402-0981
\$ **102.80**

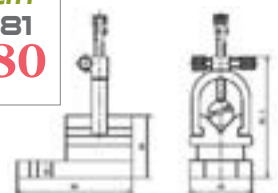

V-BLOCKS

SUPER VEE BLOCK SET

- A unique and universal holding tool for small, miniature or intricate parts, used in conjunction with larger V-blocks
- Furnished with bridges to straddle long workpieces, allowing top hold down screw of V-block clamp to be utilized
- Hardened and high-precision ground
- With fitted case

SOLD AS PAIR



SQUARENESS & PARALLELISM: .0002"

3402-0958
\$**156.75**
(E)

INCLUDES

2 V-blocks:
..... 0.030~ .156" & .050~ .281" capacity
2 bridges and 5 upper prisms:
.....1/8, 5/32 & 3/16" capacity

TRIPLE "V" STEEL V-BLOCKS SETS

- All sides hardened and precision ground parallel and square.
- "V" grooves ground central & parallel and square.
- Every angle 90°.
- Perfect alignment in matched pair.

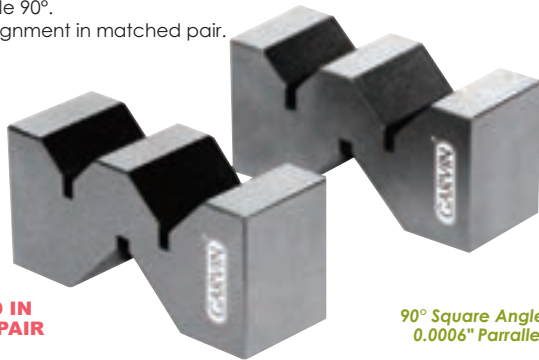

SUPPLIED IN MATCHED PAIR

90° Square Angle
0.0006" Parallel

Item #	Length	(mm) Width	Height	Suitable for Dia.	Wt. (lbs.)	Price (F)
3406-1032	50	20	14	5~33	0.5	26.60
3406-1034	100	33	52	8~60	5.1	100.52
3406-1035	125	44	69	8~75	11.1	134.64

Pro-Series STEEL V-BLOCK SETS

- Made of hardened & ground tool steel.
- Supplied in a matched pair.
- Machined to close tolerance.
- Accuracy: .00079"/per 4"
- Hardness: HRC 52.

Limited Supply!

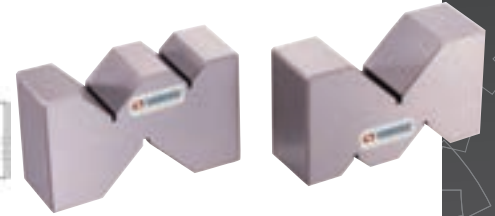
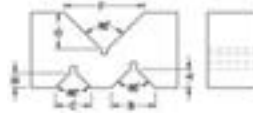

Unit: Inch

Item #	Length	Thickness	Height	Wt.	A	B	C	F	G	H	Price(F)
3402-1024	2.87	0.98	1.44	2.0 lbs.	0.39	0.87	0.71	1.57	0.71	0.31	117.78
3402-1025	3.94	1.42	2.36	6.5 lbs.	0.59	1.26	0.71	1.97	0.94	0.31	140.92

FOUR WAY V-BLOCK SETS

- Made from quality casted seasoned steel.
- Very useful tool for laying out round work & holding it for machining.
- Each block incorporates 4 different sized Vee's (90°) for wide range of jobs.

SUPPLIED IN MATCHED PAIR

90° Square Angle
0.0006" Parallel

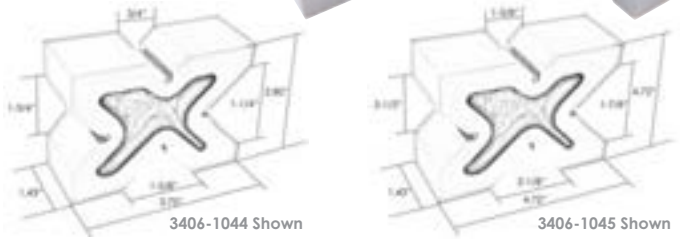

SQUARE & PARRALLEL .0008"

Item #	Length	(Inch) Thick	Height	Wt. (lbs)	Price (F)
3406-1044	3-3/4	1-3/8	2-3/4	5.4	56.84
3406-1045	4-3/4	1-3/8	4-3/4	11.8	109.04

ELONGATED STEEL V-BLOCK SETS

- All sides hardened and precision ground parallel and square.
- "V" grooves ground central & parallel and square.
- Perfect alignment in matched pair.
- Holds square and round work.

SUPPLIED IN MATCHED PAIR

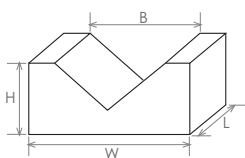

90° Square Angle
0.0003" Parallel

Item#	W	(mm) H	L	Capacity B	Wt. (lbs)	Price (F)
3406-1017	40	30	75	5~40	2.4	101.89
3406-1019	44	40	100	5~55	5.2	134.06
3406-1023	65	55	200	5~75	19	352.14

STEEL V-BLOCKS SETS

- Made of tool steel, hardened and ground.
- Machined square and parallel to meet standard specifications.

SUPPLIED IN MATCHED PAIR

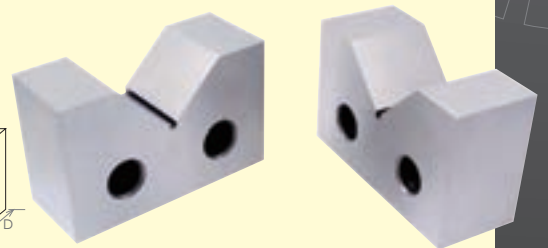
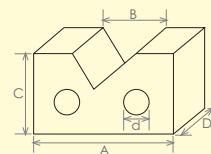

Item#	A	B	(Inch) C	D	d	Wt. (lbs)	Price (F)
3402-1302	2"	1	1.26	0.90	0.24	1.1	32.51
3402-1303	3"	1.7	2.38	1.33	0.45	4.6	64.27
3402-1304	4"	2.2	2.66	1.66	0.54	8.3	113.44
3402-1305	5"	2.45	3.14	2.03	0.78	15.3	128.40
3402-1306	6"	3.1	3.52	2.52	0.93	25	186.89

Pro-Series MAGNETIC V-BLOCKS WITH SWITCH

- Precision ground finished working surfaces.
- Ideal for scribing, grinding, measuring and machining round or irregular shape items.
- On/Off switch.

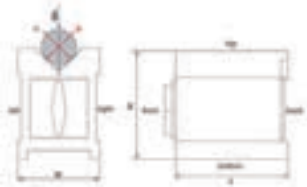

Item#	Dimensions			Vee Width	Power Pull (lbs)	Price (F)
	W	H	L			
3402-0995	2.13"	2.87"	2.76"	1.5"	66	90.40
3402-0997	2.36"	2.87"	4.29"	1.5"	77	112.97

ALUMINUM CAST MAGNETIC V-BLOCK SETS

- Holds cylindrical workpieces for grinding.
- 90° Vee blocks.
- Precision ground flat, square and parallel to 0.0005".
- Switch on/off.

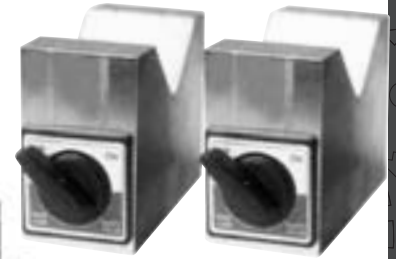
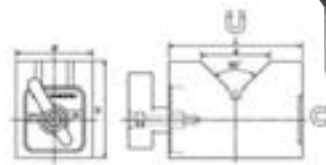

SUPPLIED IN MATCHED PAIR

Item#	Dimensions			Max. Hold Dia.	Power Pull Each (lbs)	Price (E)
	B	H	L			
3402-0890	1-1/2"	2"	2-3/4"	1.90"	33	223.87
3402-0900	2"	3"	4"	3.15"	44	219.13
3402-0902	2"	4"	6"	3.90"	50	402.18

MAGNETIC V-BLOCKS WITH SWITCH

- Precision ground finished working surfaces.
- Ideal for scribing, grinding, measuring and machining round or irregular shape items.
- On/Off switch.
- Two-centered 90° Vees.

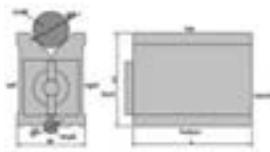

* Limited Supply

Item#	W	Dimensions		Power Pull (lbs)	Price (F)
		H	L		
3402-0990	2-3/4"	3-3/4"	3"	130	135.00
3402-0901	2-3/4"	3-3/4"	4"	250	126.91
3402-0992*	2-3/4"	3-3/4"	5"	275	186.42
3402-0993	3"	3-3/4"	6"	320	294.32

MATCHED GRANITE V-BLOCK SET

- Matched Granite V-Block Set
- 90° V-centered and parallel to bottom, two sides and ends.
- Application For Inspection and Calibration Operations.
- Grade A (0.0001"/6")
- Carrying case included.

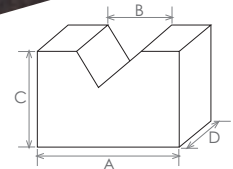

SUPPLIED IN MATCHED PAIR

Item#	Capacity (Dia.)		(mm)				Squareness & Parallelism Accuracy	Wt. (Lbs.)	Price (F)
	Min.	Max.	A	B	C	D			
3402-1312	5	63	63	38	63	63	.00012"	3.8	425.40

CAST IRON V-BLOCKS SETS

- Made of high quality casting, properly seasoned against distortion.
- Machined square and parallel to meet standard specifications.

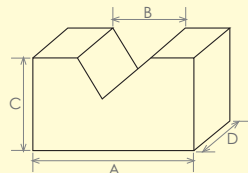

SUPPLIED IN MATCHED PAIR

Item#	A	Dimensions			Square & Parallel	Wt. (lbs)	Price (F)
		B	C	D			
3402-1000	2"	1-5/8"	1-3/8"	7/8"	0.0005"	2	19.86
3402-1001	3"	1-3/4"	2-3/8"	1-5/16"	0.0005"	3	22.68
3402-1002	4"	2-1/4"	2-5/8"	1-5/8"	0.0005"	5	39.99
3402-1003	5"	2-1/2"	3-1/8"	2"	0.0005"	8	55.68
3402-1006	6"	3-1/8"	3-1/2"	2-1/2"	0.0005"	13	80.08
3402-1007	7"	3-1/2"	4-1/2"	3"	0.0006"	27	143.00
3402-1008	8"	4-1/2"	5-1/2"	4"	0.0007"	44	239.16
3402-1010	10"	5"	6-5/8"	5"	0.001"	73	353.18
3402-1012	12"	6"	8"	7"	0.0012"	135	533.29

MAGNETIC V-BLOCKS & PARALLELS

- Universal-holds in any direction on the magnetic chuck.
- Aluminum cast.
- Ground all over.
- Blocks transmit magnetism, they are not magnetic.

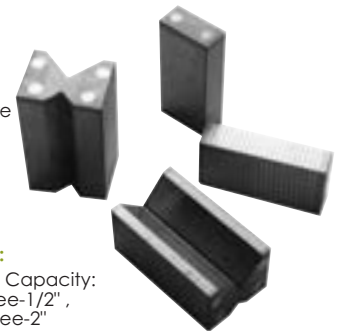

V-BLOCK & PARALLELS KIT

3402-0013

\$120.97

Item 3402-0006 & 3402-0009

V-BLOCKS:

- 90° Vee Capacity: Small Vee-1/2", Large Vee-2"

FOR USE ON MAGNETIC CHUCK

Item#	Length	Width	Height	Price (E)
SINGLE 90° V-BLOCK: 3402-0007	4-3/8"	2-3/8"	1-7/8"	77.17
MATCHED PAIR 90° V-BLOCK: 3402-0006	2"	2-3/8"	1-7/8"	75.95
MATCHED PAIR PARALLELS: 3402-0009	4"	2"	1"	59.70

ANGLE PLATES

0-60° PRECISION ANGLE BLOCKS

- For drilling, milling, and set up applications.
- 0-60° adjustable angle by locking the hex screw on the bottom.
- Squareness: - 0.0002".
- Angle accuracy: ±10'.
- Hardness: HRC 50-55.

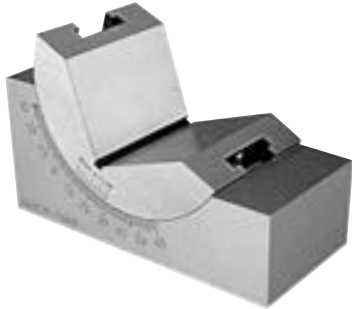

1 x 1-1/4 x 3"
(W x H x L)
3402-0010
\$7356
(F)

1-3/16 x 1-13/16 x 4"
(W x H x L)
3402-0011
\$8319
(F)

PLANER AND SHAPER GAGE

- Hardened and ground forged steel.
- Ground, flat and V ways assure accuracy.
- Both sides are ground square with working edges.
- In-built precision level.
- Base size: 5-1/4" long and 3/4" wide.
- Includes 3" extension rod.
- Supplied in wooden case.



Max. Range 6-1/4"
3402-0025
\$11463
(E)

COMPOUND ANGLE PLATE

- Features ground vees for convenient holding of small round parts
- Ground flat, square and parallel within 0.0002"
- Wall dimension: 6"x4"x1"
- Solid 1 piece steel construction
- Hardened to RC 58-62
- Tapped 16 holes: 1/4"-20
- Includes 1 clamp and 3 bolts

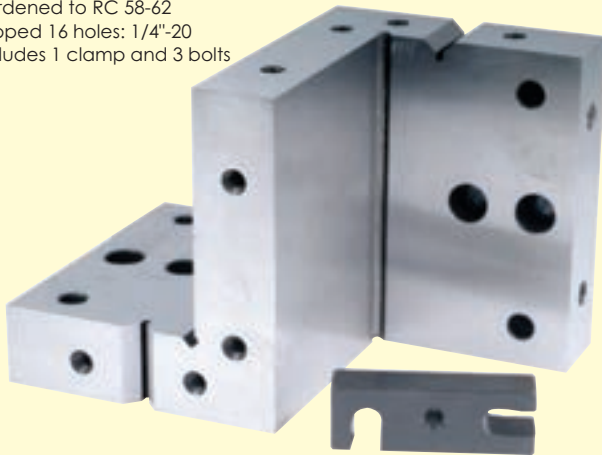

Item #	Length	Wall Height	Thickness	Tapped Holes	W.t. lbs	Price (E)
3402-1101	6"	4"	1"	(16) 1/4"-20	12	273.27

ANGLE PLATES WITH BACK HOLES

- Solid, one piece angle plate is made from hardened tool steel
- Square and parallel within .0002"
- Precision ground finishing
- (4) Bolt Holes: 7/16" diameter

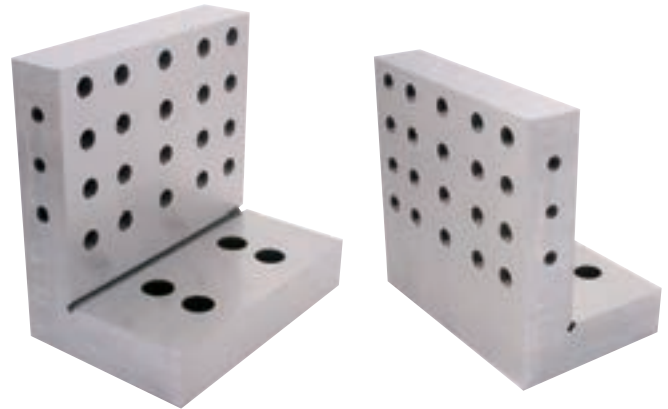

Item#	Dimension	Thread of tapped holes	W.t. (lbs.)	Price (F)
3402-2664	6x6x4x1-1/4"	(26) 1/4"-20	20	245.19

6 x 6 ULTRA PRECISION SINE PLATES



MADE IN TAIWAN

3800-5526
\$56551
(E)

HHIP PRO-SERIES

SPECIFICATIONS

Capacity:.....	0-60°
Squareness:.....	within 0.0002"
Parallelism:.....	within 0.0002"
Center Distance of Rolls Accuracy:.....	within 0.0002"
Minute Angle Step on Gage Block Roll:.....	0.200"
Tapped holes:.....	1/4"-20 UNC
Size (B x A).....	6" x 6"
Height (C).....	2.36
Center Distance of Rolls (D).....	5"
No. of Tapped Hole.....	24
Wt. (lbs.).....	18

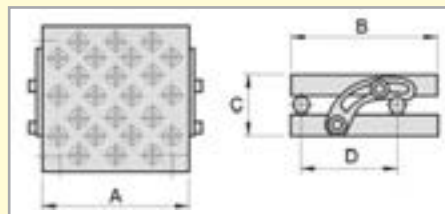

- Made of high grade tool steel hardened and precision ground HRC 55-58.
- Two hardened side rails and one locking strap included.

VALUE
3900-5526
\$24750
(E)

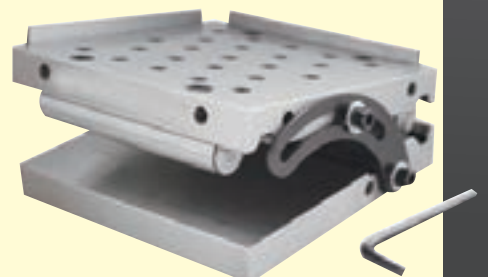

ANGLE PLATES

SLOTTED ANGLE PLATES -OPEN END

- Convenient clamping slots for mounting and are widely used for machining, layout and inspection.
- Made of high tensile cast iron properly seasoned against distortion.
- Open-End style, accurately machined square and parallel on all faces.
- Slot A is 90° to slot C.

MACHINED TO .002 PER 6"

Item#	(Inch) A x B x C	D	E	(mm) F	G	H	h	W.T. (lbs)	Price (F)
3402-0203	6 x 5 x 4-1/2	15	12	87	12	74	-	8	63.21
3402-0209	8 x 6 x 5	18	16	118	16	86	-	13	106.36
3402-0210	10 x 8 x 6	20	20	67	20	118	85	28	168.66
3402-0212	12 x 9 x 8	23	22	81	22	120	153	45	262.50

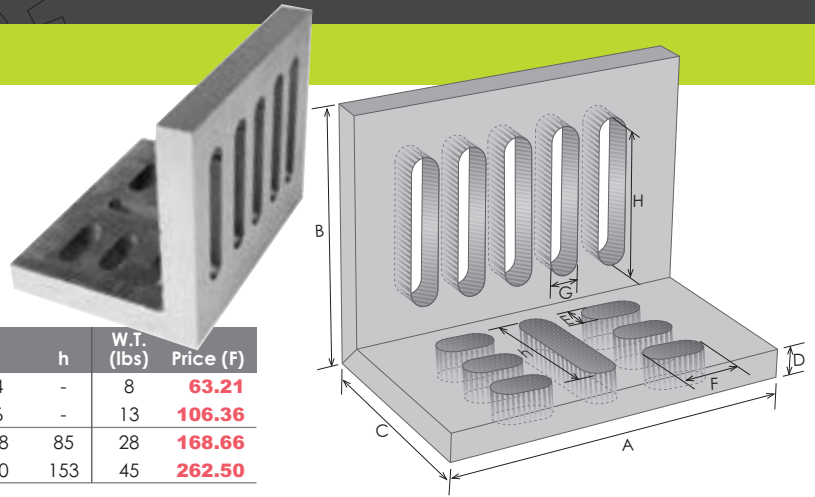

SLOTTED ANGLE PLATES -Webbed

- Made of high tensile cast iron properly seasoned against distortion.
- Clamping slots are widely used for machining, layout and inspection.
- Accurately machined and ground square and parallel on outside and ends.

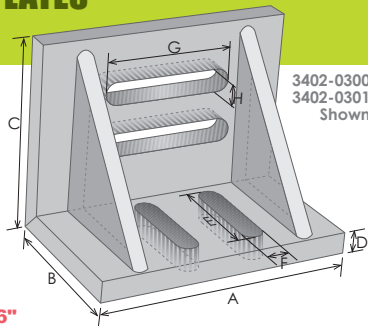

3402-0300
3402-0301
Shown

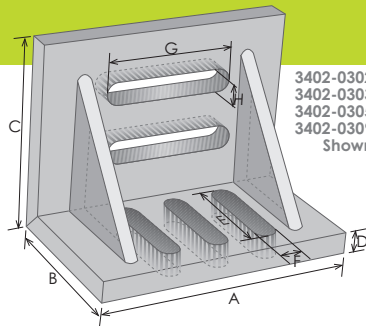

3402-0302
3402-0303
3402-0305
3402-0309
Shown

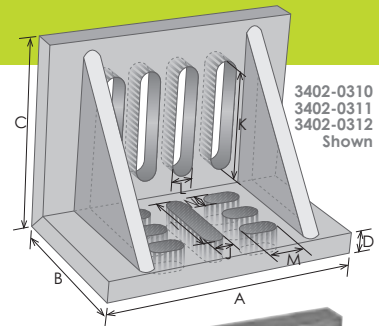

3402-0310
3402-0311
3402-0312
Shown

MACHINE TO .002 PER 6"

Item#	(Inch)			(mm)											W.T. (lbs)	Price (F)
	A	B	C	D	E	F	G	H	I	J	K	L	M	N		
3402-0300	3	2.5	2	9	40	10	37	10	-	-	-	-	-	-	5	23.37
3402-0301	3.5	3	2.5	11	48	10	47	10	-	-	-	-	-	-	6	27.51
3402-0302	4.5	3.5	3	12.5	50	11	70	11	-	-	-	-	-	-	7	27.12
3402-0303	6	5	4.5	13	74	12	86	12	-	-	-	-	-	-	11	55.84
3402-0305	7	5.5	4.5	15	88	13	105	13	-	-	-	-	-	-	14	62.61
3402-0309	8	6	5	15	98	14	105	14	-	-	-	-	-	-	17	89.24
3402-0311	9	6	7	15	-	-	-	-	94	10	116	18	52	18	27	125.93
3402-0310	10	6	8	16	-	-	-	-	89	18	130	18	52	18	38	167.72
3402-0312	12	8	9	18	-	-	-	-	128	20	150	20	58	20	50	228.36

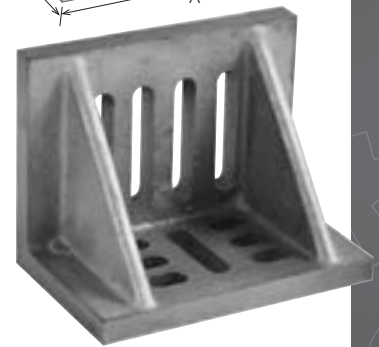

GIANT SLOTTED ANGLE PLATES-Webbed

- Machined on outside faces and with cored slots arranged for maximum clamping versatility.
- Made of high grade closegrained cast iron, stress relieved against distortion.

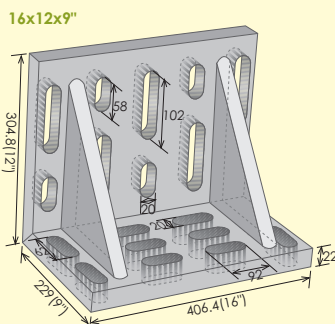

16x12x9"
3402-0340
\$44721
(F)
74 Lbs.

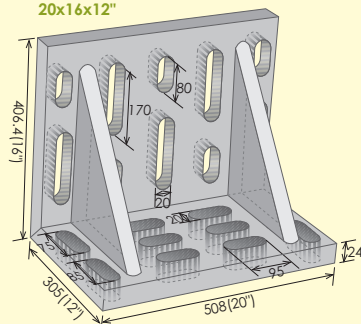

20x16x12"
3402-0342
\$89513
(F)
150 Lbs.

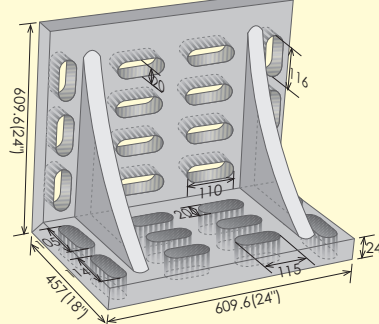

24x24x18"
3402-0344
\$1,67061
(F)
330 Lbs.

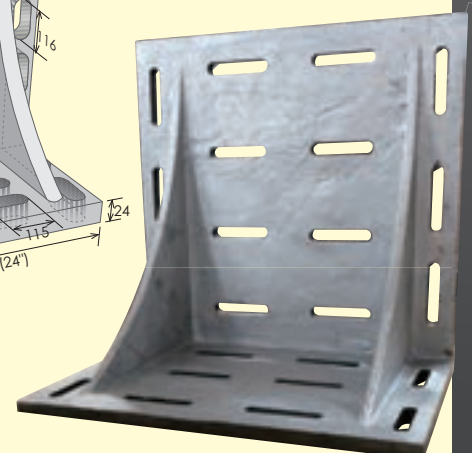

3R ROCKWELL HARDNESS TESTER

- This hardness tester is used to determine Rockwell hardness of hard alloys, quenched and unquenched steels.
- It can be applied in the laboratories, scientific research institutes and colleges.

Standard Accessories Included:

- 5-3/4" testing table.
- 2-3/16" testing table with "V" groove.
- 120° diamond penetrator.
- 1/16" steel ball penetrating.
- Rockwell A test block (1pc)
- Rockwell B test block (1pc)
- Rockwell C test block (3pc)
- Screwdrivers (2)
- Complete instruction manual.
- Dust-proof plastic cover.

SPECIFICATIONS	
Maximum load.....	330 lbs.
Load range.....	132lbs, 220lbs, 330lbs.
Initial range load.....	22 lbs.
Maximum test load.....	4-1/4"
Depth throat.....	5-1/4"
Maximum depth of spindle below base.....	2"
Base size.....	7" x18"
Height.....	24-1/2"
Approx.. weight.....	209 lbs.

8902-0150
\$2,062⁴³
(E)



Load Range	132lbs	220lbs	330lbs
Penetrator	Diamond 120	Ball 1/16"	Diamond 120
Test Scales	Rockwell A	Rockwell B	Rockwell C
Suitable for	Test on case hardened steel	Annealed ferrous & non-ferrous metal	Annealed hardened & tempered or deep case hardened steel

PENETRATORS FOR HARDNESS TESTER



Item#	Description	Price (E)
8902-0151	C Diamond	233.20
8902-0152	1/16" Steel Ball	99.51

TEST BLOCKS FOR HARDNESS TESTER



Item#	Description	Price (E)
8902-0130	20-30 HRC Test Block	44.00
8902-0155	35-55 HRC Test Block	44.00
8902-0170	60-70 HRC Test Block	43.30
8902-0188	80-88 HRA Test Block	47.80
8902-0195	85-95 HRB Test Block	44.00

6PC COMPOSITE SET OF SPECIMENS

- Each Specimen 7/8" x 3/8" of electroformed solid nickel.
- Each type of surface finish is truly and consistently reproduced with a realistic idea of the feel, appearance and texture of the machined components.
- For quick and easy comparisons.
- Conforms to S.A.E and military specifications.
- Supplied with wallet, instructions and certificate.



Item#	Surface Type	Micron Inch AA	Price (F)
4101-0024	Plain Grinding	2, 4, 8, 16, 32 & 63	35.94
4101-0025	Horizontal Milling	16, 32, 63, 125, 250 & 500	35.94
4101-0026	Vertical Milling	16, 32, 63, 125, 250 & 500	35.94
4101-0027	Turning	16, 32, 63, 125, 250 & 500	39.53
4101-0028	External Grinding	8, 16, 32 & 63	38.06

COMPOSITE SET OF SURFACE ROUGHNESS STANDARDS

- 30 Specimens 7/8" x 3/8" of electroformed solid nickel.
- Each type of surface finish is truly and consistently reproduced with a realistic idea of the feel, appearance and texture of the machined components.
- For quick and easy comparisons.
- Conforms to S.A.E and military specifications.
- Supplied with wallet, instructions and certificate.

4101-0030
\$245⁶⁶
(E)



SPECIFICATIONS	
Horizontal Milling (6 specimens)	16, 32, 63, 125, 250 and 500*
Vertical Milling (6 specimens)	16, 32, 63, 125, 250 and 500*
Turning (6 specimens)	16, 32, 63, 125, 250 and 500*
Plain Grinding (6 specimens)	2, 4, 8, 16, 32 and 63*
Flat Lapping (2 specimens)	2 and 4*
External Grinding (4 specimens).....	8, 16, 32 and 63*

* Micron Inch AA

MICROSCOPES & BORESCOPES

20X & 40X STEREO MICROSCOPE

- Optical glass lens.
- Illuminator both stand and overhead switchable.
- Stereo body rotatable 360°.
- Possible magnification from 20 x through 80 x (Depending upon accessories selected).
- Dioptic adjustment: Ø5 diopter
- Eyepiece: 10X , 30.50 mm (insertion part)
- objective: 2X & 4X rotatable
- Direct measuring on workpiece.
- Microscope illuminator (tungsten) 10W, 12V.
- Impeccable performance through coated optics assures better resolution.
- Locking adjustable head.
- Stage difussing glass: Ø3-3/4"
- Eyepiece rubber protectors & dust cover included.
- Power supply: 115V / 60Hz / 1PH.



Limited Supply!

Item#	Description	Price (E)
8902-3005	5X Eyepiece (Pair)	34.98
8902-3015	15X Eyepiece (Pair)	23.38
8902-3020	20X Eyepiece (Pair)	25.26
8902-3081	Replacement Bulb	3.25

20x & 40x Microscope
8902-0302
\$19067 (E)

STEREO MICROSCOPE WITH UNIVERSAL STAND-BOOM STAND

- Optical glass lens.
- Stand with 11" vertical and 9" horizontal extension bar with chrome finished.
- Stand: 8" L x 4.6" W x 2.5" H.
- Rack & pinion focus adjustable.
- Locking collar.
- Universal movement with no limit for most working applications.
- Focal Distance: 4.50"
- Illumination system: (halogen, top only) attached with head of microscope.
- Eyepiece rubber protectors & dust cover included.
- Power supply: 110V/60Hz/1Ph.



Limited Supply!

20x Microscope
8902-0050
\$20912 (E)
10x eyepiece & 2x objective

Item#	Description	Price (E)
8902-3005	5x Eyepiece (pair)	34.98
8902-3015	15x Eyepiece (pair)	23.38
8902-3020	20x Eyepiece (pair)	25.26
8902-5081	Replacement Bulb 10W	6.21

MICROSCOPE HALOGEN LIGHT

- Portable light to provide illumination image for microscope or other application.
- Universal movement arm.
- Power On/Off switch.
- 4 steps brightness 3, 6, 9 & 12.
- Max. Height: 10-1/2".
- Power Supply (5 ft. cord): 115 V/60 Hz, 15 W.



Limited Supply!

8902-6007
\$7512 (E)

SPARE BULB 15W (Item #8902-3086).....\$8.95(E)

VIDEO BORESCOPE WITH LCD DISPLAY

- Vivid 2.4" color TFT LCD monitor allows image rotation for detailed images
- 39" flexible gooseneck cable retains configured shape.
- Optional 78" flexible shaft with 9mm or 17mm camera available
- Mini waterproof 9mm (IP67) camera head provides on-the-spot viewing.
- Night Vision Range: 20".
- Power indicator, low voltage indicator.
- Mirror button.
- LED brightness control.
- LCD contrast control.
- Power Supply: 4 x AA battery.
- Dimension: (WxDxH) 8x3.3x2.4".
- Operating Temperature: 14 ~122° F.
- Weight: 14 oz.

9mm Camera, 39" Shaft
8902-0065
\$10724 (E)

Light, handheld design enables you to easily find, diagnose and solve problems in hard-to-reach areas. Perfect for all kinds of inspections.



Limited Supply!

640 X 480 PIXEL



3 Useful Accessories Included.



OPTIONAL EXTENSION CABLES WITH CAMERA

Item#	Camera Head	Shaft Length	Price (E)
8902-6010	9mm (IP67)	78"/2M	96.24
8902-6017	17mm (IP67)	78"/2M	96.24

FLEXIBLE SHAFT IP54 WATER RESISTANT LED WORK LIGHT

- CREE XPG high performance LED light provide an excellent solution for heat sensitive environment.
- Small head (0.8" Diameter) with zoom ring for adjusting brightness
- IP54 dustproof and waterproof
- Strong magnetic base with 1.5" diameter grip can be handled as a flash light or stick on a metal surface.
- Battery Run Time: 8 hours high(200 LUMENS), 20 hours low(80 LUMENS)
- On/Off button
- 18" flexible shaft.
- Use 3xAA battery.

IP 54



OVERALL LENGTH: 24"
BRIGHTNESS: 200 LUMENS

8401-0439
\$2874 (F)



Unit: mm

10X POCKET OPTICAL COMPARATOR SET

- Widely used by machinists, toolmakers and inspectors for checking angles, diameters, radii, thread pitches, hole sizes, etc.
- The scales are photo etched into glass reticle for easy reading.
- Reticle screw-in mounting are interchangeable.
- **9 pc/set includes: Comparator and 8 pc Reticle.**
- Lens diameter: 21mm

10x POWER
8902-0041
\$138³⁷
 (E)

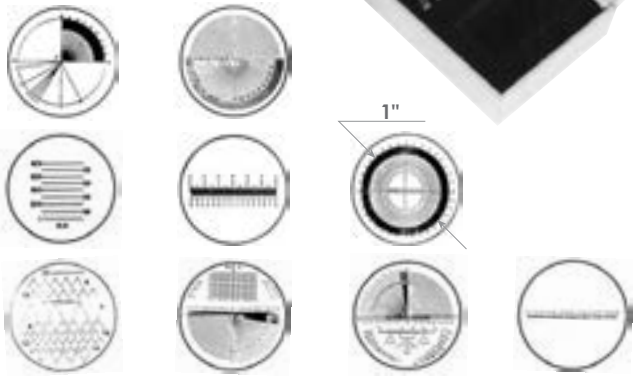

HASTINGS TRIPLET MAGNIFIER

- Triplet lens system
- Case color: black



Item#	Power	Lens Dia.	Price (F)
4902-0045	10 X	21mm	34.22

8X LED LIGHT DESK TOP MAGNIFIER

- 8x powerful magnifier
- Flexible arm any desired position adjustable
- Diameter of Visible Area: 5"
- Adjustable LED light with 300 LUX brightness, 2.5Watt.
- Power Supply: 110V/1 phase
- Furnished with 60" cord.



8070-0001
\$71⁵⁰
 (F)

SPARE LED BULB 2.5W (Item #8070-0004)\$1.70(F)

20X SHOP MICROSCOPE

- Easy focal adjustment .
- Illuminated light allows use in dark places and are adjustable.
- 2 in 1 metric and inch straight line scale.
- Operations on 2 AAA battery.



Limited Supply!

20x POWER
8902-0035
\$88⁰⁰
 (E)

40X, 80X SHOP MICROSCOPES WITH RETICLE

- Wide field eyepiece with direct reading reticle (no calibration required). Eyepiece turns to permit sharp focus of reticle scale
- Penlight illuminator in swivel mount. requires 2 AAA batteries
- Jack and pinion focusing with dual focusing knobs
- Cast aluminum structure
- Height: 9"

RETICLE: 0-18mm/.02mmx90

40x POWER
8902-0036
\$90⁰³
 (E)

80x POWER
8902-0037
\$93⁸⁶
 (E)



Limited Supply!

INDUSTRIAL GRADE LED LAMP MAGNIFIER

- Light source LED, 390 Lums brightness.
- Lens Size: 7.5x6.0".
- Lens frame: 12x9".
- Lens material: glass.
- 3 diopter lens provides 1.75x magnification.
- Swing arm with 32" reach.
- Max. 2-1/2" adjustable bench clamp.
- Power On/Off switch.
- Power Supply: 115V.



8401-0045
\$165¹³
 (E)

DRILLS & SETS

29PC JOBBER DRILL SETS

- Production grade
- Straight shank **1/16~1/2" by 64ths**
- Right hand
- Supplied in metal drill index
- **COBALT** used for drilling in tough high tensile strength materials like stainless steel, titanium and inconel
- **TiN Coated** will improve the tool life and is used where elevated speeds & feeds are the objective. TiN provides high lubricity and facilitates chip flow which reduces heat and edge build-up.

M35 (5%) Cobalt
5000-0011
\$ **187⁰⁰**
(E)

Bright Finish, HSS
5001-0029
\$ **175⁶⁹**
(E)

TiN Coated, HSS
5000-0001
\$ **35⁹¹**
(E)

Black Oxide, HSS
5000-0002
\$ **27⁸⁰**
(E)



HSS WIRE GAGE DRILL SETS

- Supplied in metal index case
- High speed steel
- Right hand

20 PC SET
#61~80
5001-1020
\$ **182⁶**
(F)

61 PC SET
#1~60
5001-1060
\$ **427²**
(F)



5001-1020 Shown

NC SPOTTING DRILLS - M35 5% COBALT RIGHT HAND • 90° SPLIT POINT

- Ground from solid.
- Designed for quick starting and a constant web to allow for re-sharpening without the need for web thinning.

MADE FOR CNC DRILLING!



Limited Supply!



Dia. A	Flute Length B	OAL C	Item#	Price (E)
.197" (5mm)	1"	2-3/8"	5000-1004	4.18
.236" (6mm)	1"	2-3/4"	5000-1006	4.66
.315"	1-1/8"	3-1/8"	5000-1010	8.39
3/8"	1-1/8"	3-1/2"	5000-1012	14.40
1/2"	1-1/2"	4"	5000-1018	24.72
3/4"	1-3/4"	5-1/8"	5000-1024	60.46

29PC HSS BLACK & GOLD JOBBER DRILL SET

- Premium high-speed steel withstands extended drilling in tough materials.
- Black and gold oxide finish provide maximum corrosion resistance.
- 135-degree split-point tip starts drilling immediately with less force and eliminates "walking" across the work surface.
- Metal USA made index case for easy bit access and identification.
- Includes drill bit sizes 1/16- to 1/2-inch in 1/64-inch increments.
- Reduced Tri-Flat shank from 5/32" to 1/2"

1/16~1/2" by 64ths
5000-0006
\$ **97¹⁷**
(F)



115PC HSS JOBBER DRILL SETS

SET INCLUDES: 1/16~1/2" By 64ths, #1~60, A~Z

- Supplied in metal drill index
- Production grade
- High speed steel
- **TiN Coated** will improve the tool life and is used where elevated speeds & feeds are the objective. TiN provides high lubricity and facilitates chip flow which reduces heat and edge build-up.
- Right hand
- Straight shank

Bright Finish
5001-0115
\$ **516³²**
(E)

TiN Coated
5000-0003
\$ **155²³**
(E)



25PC METRIC 118° DRILL SET

- Production grade
- High speed steel
- Black surface treated

MM DRILL SETS IN METAL INDEX

Item#	Set	Range	Price (F)
5000-0007	25	1~13mm x 0.5mm	30.08



19PC COBALT METRIC DRILL SET-135°

- Cobalt is used for drilling in tough high tensile strength materials like stainless steel, titanium and inconel.
- 135° split point provides self-centering properties and secure positioning on work surface face treatment increases abrasion resistance.
- With index steel case.
- Ground from solid blank.

1~10MM X 0.5MM
5000-0005
\$ **44⁵⁰**
(E)

Set Includes
1.0, 1.5, 2.0, 2.5, 3.0,
3.5, 4.0, 4.5, 5.0, 5.5,
6.0, 6.5, 7.0, 7.5, 8.0,
8.5, 9.0, 9.5, 10MM



18PC HSS TAP & DRILL COMBO SETS

- High speed steel made taps and drills.
- Steel case.
- Drills are matched with taps to make jobs much easier.



National Course Pitch Set Includes

1 each HSS Hand Tap
6-32 NC, 8-32 NC, 10-24 NC, 10-32 NF,
1/4"-20 NC, 5/16"-18 NC, 3/8"-16 NC,
7/16"-14 NC, 1/2"-13 NC
1 each HSS Jobbers Drill
#36, #29, #25, #21, #7, F, 5/16" .U, 27/64"

National Fine Pitch Set

1011-0019
\$65⁹⁶

National Course Pitch Set

1011-0018
\$72²²

National Fine Pitch Set Includes

1 each HSS Hand Tap
6-40 NF, 8-36 NF, 10-24 NF, 10-32 NF,
1/4"-28 NF, 5/16"-24 NF, 3/8"-24 NF,
7/16"-20 NF, 1/2"-20 NF
1 each HSS Jobbers Drill
#33, #29, #25, #21, #3, I, Q, 25/34", 29/64"



18PC HSS METRIC TAP & DRILL COMBO SET

- High speed steel made taps and drills.
- Plug taps are fully ground.
- With index steel case.
- Drills are matched with taps to make jobs much easier.

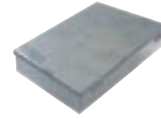

M2.5 ~ M12
1011-0020
\$65⁷⁵



Set Includes

1 each HSS Hand Tap
M2.5x0.45, M3.0x0.50, M3.5x0.60,
M4.0x0.70, M5.0x0.80, M6.0x1.00,
M8.0x1.25, M10.0x1.50 & M12.0x1.75
1 each HSS Jobbers Drill
2.05, 2.50, 2.90, 3.30, 4.20, 5.00, 6.70, 8.50
& 10.20mm



14 PC H.S.S. 3-IN-1 COMBINED DRILL/TAP/COUNTERSINK & SCREWDRIVER BIT SETS

- Complete hole drilling, tapping, deburring and countersinking in one operation with power drill saves labor and time.
- For use to tap steel, copper, brass, aluminum and plastic up to 10-gauge (metal).
- Back tapered design helps prevent thread damage from over-drilling.
- One-piece drill/tap assures proper drill for tap size.
- Made of high speed steel for longer life.
- 14pc Includes: 6pc of combination drill & tap countersink.
1pc of high torque tested quick-change adapter
6pc of quick change CRV steel bit.
1pc of carry case.



1011-0141 Shown



INCH SET
#6-1/4"
1011-0140
\$32⁹⁹



1011-0140 Shown

Item#	Thread Range	CRV Bit	Price (F)
1011-0140	6~32, 8~32, 10~24 10~32, 12~24, 1/4~20	Slot3, Slot4, PZ1 PZ2, PH1, PH2	32.99
1011-0141	M3X0.5, M4x0.7, M5x0.8, M6x1.0, M8x1.25 & M10x1.5	Slot3, Slot4, PZ1 PZ2, PH1, PH2	35.49

M35 5% COBALT DRILLS 135° SPLIT POINT

- **COBALT** used for drilling in tough high tensile strength materials like stainless steel, titanium and inconel
- **135° SPLIT POINT** provides self-centering properties and secure positioning on work surface face treatment increases abrasion resistance

GROUND FROM SOLID



Size	OAL	Item#	Price (F)	Size	OAL	Item#	Price (F)
1/16	1-7/8	5002-4004*	0.73	19/64	4-3/8	5002-4019*	4.69
5/64	2	5002-4005*	0.57	5/16	4-1/2	5002-4020	7.33
3/32	2-1/4	5002-4006	0.95	21/64	4-5/8	5002-4021*	6.86
7/64	2-5/8	5002-4007*	0.77	11/32	4-3/4	5002-4022*	7.59
1/8	2-3/4	5002-4008	1.94	23/64	4-7/8	5002-4023*	8.82
5/32	3-1/8	5002-4010	2.41	3/8	5	5002-4024	12.96
11/64	3-1/4	5002-4011*	1.78	25/64	5-1/8	5002-4025*	10.82
3/16	3-1/2	5002-4012	2.59	13/32	5-1/4	5002-4026*	9.92
13/64	3-5/8	5002-4013*	2.22	27/64	5-3/8	5002-4027*	11.15
7/32	3-3/4	5002-4014	3.65	7/16	5-1/2	5002-4028*	12.76
15/64	3-7/8	5002-4015*	2.93	29/64	5-5/8	5002-4029*	13.11
1/4	4	5002-4016	4.93	15/32	5-3/4	5002-4030*	14.39
17/64	4-1/8	5002-4017*	4.80	31/64	5-7/8	5002-4031*	18.02
9/32	4-1/4	5002-4018	6.98	1/2	6	5002-4032	24.99

* Limited Supply

SOLID CARBIDE DRILLS STANDARD LENGTH, 118° SPLIT POINT

- **SOLID CARBIDE** used for low tensile strength materials such as zinc, brass, plastics and other abrasive material



Size	OAL	Item#	Price (E)	Size	OAL	Item#	Price (E)
1/16	1-1/2	5003-4004	16.28	21/64	4	5003-4021*	60.73
5/64	1-3/4	5003-4005*	10.38	11/32	4	5003-4022	71.63
3/32	2	5003-4006	11.75	23/64	4-1/4	5003-4023*	51.53
7/64	2-1/4	5003-4007*	12.93	3/8	4-1/4	5003-4024	83.60
1/8	2-1/4	5003-4008	14.63	25/64	4-1/4	5003-4025*	53.13
9/64	2-1/2	5003-4009*	15.95	13/32	4-1/4	5003-4026	59.08
5/32	2-1/2	5003-4010	16.78	27/64	4-1/4	5003-4027*	77.50
3/16	2-3/4	5003-4012	21.62	7/16	4-1/4	5003-4028	83.98
7/32	3	5003-4014	31.48	29/64	4-3/4	5003-4029*	128.70
1/4	3-1/4	5003-4016	28.75	15/32	4-3/4	5003-4030	98.05
9/32	3-1/2	5003-4018	33.00	31/64	4-3/4	5003-4031*	92.65
19/64	3-3/4	5003-4019*	30.53	1/2	4-3/4	5003-4032	104.40
5/16	3-3/4	5003-4020	38.58				

* Limited Supply

DRILLS & SETS

SILVER & DEMMING DRILLS & SET 118° DRILL POINT • 1/2" STRAIGHT SHANK

- High Speed Steel.
- 6" overall length.
- Black oxide.
- Set supplied with case.

**8PC SET,
9/16~1" x16ths
5000-0010
\$46⁴⁰
(E)**



INDIVIDUALS

Item#	Size	Price (E)
5000-0050	17/32"	6.11
5000-0052	9/16"	6.40
5000-0056	5/8"	6.58
5000-0060	11/16"	8.29
5000-0064	3/4"	9.15
5000-0068	13/16"	10.40
5000-0072	7/8"	15.37
5000-0076	15/16"	17.29
5000-0078*	31/32"	9.77
5000-0080	1"	19.69
5000-0088	1-1/8"	23.45
5000-0094	1-1/4"	29.85
5000-0097	1-3/8"	44.95
5000-0099	1-1/2"	56.06

* Limited Supply

13PC M35 COBALT SILVER & DEMMING DRILL SET 118° DRILL POINT • 1/2" STRAIGHT SHANK

- M35 (5%) cobalt used for drilling in tough high tensile strength materials like stainless steel, titanium and inconel.
- 6" overall length.
- Supplied with case.

13 PC SET INCLUDES:
17/32, 9/16, 19/32, 5/8, 21/32,
11/16, 23/32, 3/4, 13/16, 7/8,
15/16, 31/32 & 1"

**13 PC SET
5000-0012
\$426⁴⁷
(E)**

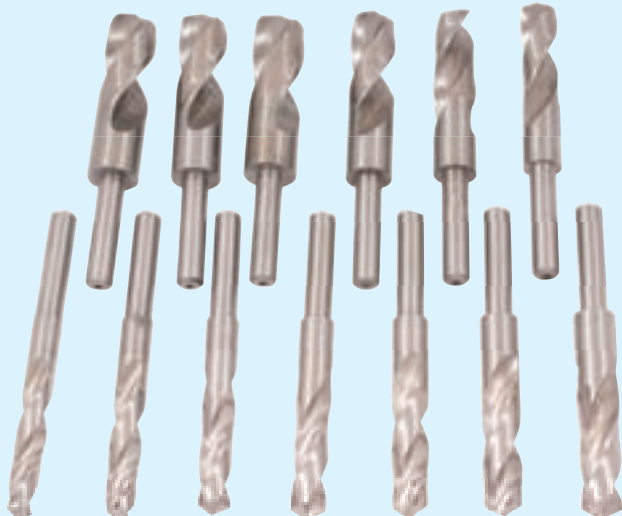

METRIC SILVER & DEMMING DRILLS 118° DRILL POINT • 1/2" STRAIGHT SHANK

NEW

- High Speed Steel.
- 6" overall length.
- Black oxide.



Item#	Size	Price (E)
5000-0140	14mm	5.16
5000-0145	14.5mm	6.08
5000-0150	15mm	6.08
5000-0155	15.5mm	6.36
5000-0160	16mm	6.36
5000-0165	16.5mm	6.36
5000-0170	17mm	7.68
5000-0175	17.5mm	7.68
5000-0180	18mm	7.68
5000-0185	18.5mm	7.92
5000-0190	19mm	8.44
5000-0195	19.5mm	8.44
5000-0200	20mm	9.96
5000-0205	20.5mm	9.96
5000-0210	21mm	10.60
5000-0220	22mm	11.96
5000-0230	23mm	13.44

HSS TAPER SHANK DRILLS 118° SPLIT POINT

- Designed for drilling in many different materials and a wide range of applications. These drills feature a surface treatment to improve chip flow and a taper shank made to American National Standard (Morse) dimensions. Black oxide finish for increased wear resistance and improved lubricity, reducing chip welding and galling.



Item#	Dia. d1	Flute Length l2	Shank Taper	OAL l1	Price (F)
5302-1020	5/16	3-1/8	1MT	6-3/8	5.16
5302-2024	3/8	3-1/2	2MT	7-3/8	5.16
5302-2028	7/16	3-7/8	2MT	7-3/4	5.16
5302-2036	9/16	4-7/8	2MT	8-3/4	6.79
5302-2040	5/8	4-7/8	2MT	8-3/4	7.39
5302-2044	11/16	5-3/8	2MT	9-1/4	8.64
5302-2048	3/4	5-7/8	2MT	9-3/4	9.86
5302-2052	13/16	6-1/8	2MT	10	11.71
5302-3044	11/16	5-3/8	3MT	10	8.64
5302-3052	13/16	6-1/8	3MT	10-3/4	11.71
5302-3056	7/8	6-1/8	3MT	10-3/4	14.11
5302-3060	15/16	6-1/8	3MT	10-3/4	18.43
5302-3100	1	6-3/8	3MT	11	19.06
5302-3104	1-1/16	6-5/8	3MT	11-1/4	23.98
5302-3108	1-1/8	7-1/8	3MT	11-3/4	25.22
5302-3116	1-1/4	7-7/8	3MT	12-1/2	38.74
5302-4112	1-3/16	7-3/8	4MT	13	33.84
5302-4116	1-1/4	7-7/8	4MT	13-1/2	38.74
5302-4120	1-5/16	8-5/8	4MT	14-1/2	41.93
5302-4124	1-3/8	8-7/8	4MT	14-1/2	46.13
5302-4132	1-1/2	9-3/8	4MT	15	61.67
5302-4136	1-9/16	9-5/8	4MT	15-1/4	65.88
5302-4140	1-5/8	10	4MT	15-5/8	65.88
5302-4148	1-3/4	10-3/8	4MT	16-1/4	75.62
5302-4200	2	10-5/8	4MT	16-5/8	110.88

HSS & M35 COBALT ANNULAR CUTTERS, 3/4" SHANK

- HSS Production grade.
- Pilot holes.
- For general purpose hole making.
- Made of **high speed steel**, heat treated and tempered for maximum strength.
- Hardened and ground.
- **M35 Cobalt (5%)** is designed to cut difficult and abrasive materials, ranging from medium to high hardness, such as castings and forgings. They have high heat and abrasion resistant properties and are best used when making heavy cuts, at high speeds and feeds, or where high heat is a factor.
- Pilot holes.
- Produces a slug of material.



3/4" SHANK

* Limited Supply

Size	HSS (High Speed Steel)		M35 (5% Cobalt)		1" Depth of Cut Item#	2" Depth of Cut Item#	1" Depth of Cut Price(F)	2" Depth of Cut Price(F)
	1" Depth of Cut Item#	2" Depth of Cut Price(F)	1" Depth of Cut Item#	2" Depth of Cut Price(F)				
7/16"	5020-0437	22.33	5021-0437	37.73	-----	-----	-----	-----
1/2	5020-0500	22.56	5021-0500	33.51	5022-0500	5023-0500	35.39	51.35
9/16	5020-0562	26.81	5021-0562	42.22	5022-0562	-----	45.42	-----
5/8	5020-0625	29.09	5021-0625	45.57	5022-0625	5023-0625	44.25	58.58
11/16	5020-0687	32.01	5021-0687	47.39	5022-0687	-----	44.25	-----
3/4	5020-0750	32.44	5021-0750	49.01	5022-0750	5023-0750	44.25	75.31
13/16	5020-0812	32.66	5021-0812	54.37	5022-0812	-----	41.42	-----
7/8	5020-0875	36.76	5021-0875	57.92	5022-0875	5023-0875	49.32	68.67
15/16	5020-0937	37.60	5021-0937	61.85	5022-0937	-----	47.61	-----
1	5020-1000	41.86	5021-1000	63.12	5022-1000	5023-1000	53.79	76.10
1-1/16	5020-1062	44.01	5021-1062	71.05	5022-1062	5023-1062*	61.20	58.22
1-1/8	5020-1125	46.15	5021-1125	74.30	5022-1125	5023-1125	68.70	80.31
1-3/16	5020-1187	47.39	5021-1187	81.45	5022-1187	-----	67.99	-----
1-1/4	5020-1250	51.77	5021-1250	87.26	5022-1250	5023-1250	81.61	107.41
1-5/16	5020-1312	53.69	5021-1312	92.95	5022-1312*	-----	68.51	-----
1-3/8	5020-1375	59.12	5021-1375	100.52	5022-1375	5023-1375	84.03	122.33
1-7/16	5020-1437	64.16	5021-1437	90.45	-----	-----	-----	-----
1-1/2	5020-1500	68.54	5021-1500	105.66	5022-1500	5023-1500	94.54	134.58
1-9/16	5020-1562	69.16	5021-1562	108.52	5022-1562*	-----	95.00	-----
1-5/8	5020-1625	74.26	5021-1625	124.41	5022-1625	5023-1625	101.35	149.50
1-11/16	5020-1687	84.18	5021-1687	125.91	5022-1687	-----	108.73	-----
1-3/4	5020-1750	90.25	5021-1750	141.64	5022-1750	5023-1750	139.05	156.88
1-13/16	5020-1812	96.69	5021-1812	143.91	5022-1812	-----	124.80	-----
1-7/8	5020-1875	95.71	5021-1875	148.62	5022-1875*	-----	108.75	-----
1-15/16	-----	-----	5021-1937	151.06	5022-1937	-----	132.81	-----
2	5020-2000	103.81	5021-2000	165.56	5022-2000	-----	137.12	-----

9PC 1/2 INCH CUTTING DEPTH HSS ANNULAR CUTTER SET

- Material Application: Hardened Steel; Mild Steel; Stainless Steel
- Bright Finish, High Speed Steel
- Thread Mount Shank
- 1/2 Inch Cutting Depth
- 7/8 to 1-1/2 Inch Cutter Diameter
- 1/2-20 Thread Hole.

9PC SET
5020-5001
\$20735
(F)

Set Includes:

- 6 - Annular Cutters 7/8, 1, 1-1/8, 1-1/4, 1-3/8 & 1-1/2"
- 1 - Arbor Assembly
- 1 - Center Punch
- 1 - Pilot
- Fitted Case



PIN FOR ANNULAR CUTTER



- Fits annular cutters.
- Hardened and ground.

For 1" Depth Cutter
5020-0003
\$474
(F)
6.34/5.30 x 77mm

For 2" Depth Cutter
5020-0006
\$549
(F)
6.34/5.30 x 102mm

OPTICAL PUNCH SET & 4PC CENTER DRILL SET COMBO KIT

NEW

- This optical punch set is indispensable when doing critical layout work. Just look down the magnifying lens and align the cross hairs with the mark on your workpiece. Replace the magnifier with the supplied punch and give it a tap.
- Punch set includes 3 components: a bulls eye and cross hair lens, a 120 degree made of tempered steel, precisely manufactured of aluminum main body and fitted case.

- 4pc HSS combined drill & countersink set: #1-#4
- Made of high speed steel and ground.
- Plain style.
- Used for centering work ends. Where the workpiece is to be revolved on machine centers, 80° countersink angle fits all standard centers.



Lens Magnifier Power: 9x
Punch Size: 3/8"
Pin Length: 1.85"

Combo Kit
8600-4122
\$7392
(E)

Size	Body Dia.	(Inch) Drill Dia.	OAL
1	1/8	3/64	1-1/4
2	3/16	5/64	1-7/8
3	1/4	7/64	2
4	5/16	1/8	2-1/8

COMBINED DRILLS & COUNTERSINKS

HSS COMBINED DRILLS & COUNTERSINKS

- Made of high speed steel and ground.
- Plain style.
- Used for centering work ends, where the workpiece is to be revolved on machine centers, 60° countersink angle fits all standard centers.

GROUND FROM SOLID



Item#	Size	Body Dia.	(Inch) Drill Dia.	OAL	Price (F)
5000-2020	000	1/8	.020	1-1/4	2.32
5000-2025	00	1/8	.025	1-1/4	1.95
5000-2031	0	1/8	1/32	1-1/4	1.90
5000-2047	1	1/8	3/64	1-1/4	1.74
5000-2078	2	3/16	5/64	1-7/8	1.90
5000-2109	3	1/4	7/64	2	2.15
5000-2125	4	5/16	1/8	2-1/8	3.13
5000-2187	5	7/16	3/16	2-3/4	5.55
5000-2218	6	1/2	7/32	3	7.85

Pro-Series 8PC HSS CENTER DRILL SET

- Made of high speed steel and precision ground to accuracy.
- Plain style.
- Used for centering work ends, where the workpiece is to be revolved on machine centers, 60° countersink angle fits all standard centers.



Dimensions

Size	Body Dia.	(Inch) Drill Dia.	OAL
1	1/8	3/64	1-1/4
2	3/16	5/64	1-7/8
3	1/4	7/64	2
4	5/16	1/8	2-1/8
5	7/16	3/16	2-3/4
6	1/2	7/32	3
7	5/8	1/4	3-1/4
8	3/4	5/16	3-1/4

#1~#8
5000-3003
\$49.29 (F)

HSS COMBINED DRILL & COUNTERSINK SETS

- Made of high speed steel and ground.
- Plain style.
- Used for centering work ends, where the workpiece is to be revolved on machine centers, 60° countersink angle fits all standard centers.

4PC SET
SIZE: #1~#4
5000-0019
\$711 (F)

GROUND FROM SOLID



Dimensions

Size	Body Dia.	(Inch) Drill Dia.	OAL
1	1/8	3/64	1-1/4
2	3/16	5/64	1-7/8
3	1/4	7/64	2
4	5/16	1/8	2-1/8
5	7/16	3/16	2-3/4

5PC SET
SIZE: #1~#5
5000-0020
\$1187 (F)

M42 8% COBALT CENTER DRILLS

- **COBALT** used for drilling in tough high tensile strength materials like stainless steel, titanium and inconel
- Plain style.
- Used for centering work ends, where the workpiece is to be revolved on machine centers, 60° countersink angle fits all standard centers.



GROUND FROM SOLID

Item#	Size	Body Dia.	(Inch) Drill Dia.	OAL	Price (F)
5000-3020	000	1/8	.020	1-1/4	2.49
5000-3025	00	1/8	.025	1-1/4	2.49
5000-3031	0	1/8	1/32	1-1/4	2.56
5000-3047	1	1/8	3/64	1-1/4	2.54
5000-3078	2	3/16	5/64	1-7/8	2.67
5000-3109	3	1/4	7/64	2	3.41
5000-3125	4	5/16	1/8	2-1/8	4.28
5000-3187	5	7/16	3/16	2-3/4	11.57
5000-3218	6	1/2	7/32	3	16.33

COBALT

M42 Cobalt (8%) is designed to cut difficult and abrasive materials, ranging from medium to high hardness. Roughing end mills are made of cobalt to withstand elevated temperatures and assure high-edge hardness during rapid stock removal. Choose cobalt end mills on hardwork materials or when there is a problem with wear or short tool life.

HSS LONG SERIES CENTER DRILLS

- Made of high speed steel and ground.
- Combined drills and countersinks (60°).

GROUND FROM SOLID



Item#	Size	OAL	(Inch) Body Dia.	Drill Dia.	Price (F)
5000-0025	1	4	1/8	3/64	3.68
5000-0027	1	6	1/8	3/64	4.71
5000-0029	2	4	3/16	5/64	6.66
5000-0031	2	6	3/16	5/64	5.88
5000-0032	3	4	1/4	7/64	4.75
5000-0034	3	6	1/4	7/64	6.24
5000-0035	4	4	5/16	1/8	6.68
5000-0036	4	5	5/16	1/8	6.49
5000-0038	5	4	7/16	3/16	8.93
5000-0040	5	6	7/16	3/16	14.69
5000-0041	6	4	1/2	7/32	16.83
5000-0043	6	6	1/2	7/32	23.13

5PC M42 8% COBALT 60° CENTER DRILL SET

- **COBALT** used for drilling in tough high tensile strength materials like stainless steel, titanium and inconel
- Plain style.
- Used for producing center holes on parts that require matching between centers right hand cut.
- Creates 60° countersink.
- Double end provides two cutting ends.
- Right hand cut.

5PC SET
SIZE: #1~#5
5000-3011
\$2599 (F)

GROUND FROM SOLID



Dimensions

Size	Body Dia.	(Inch) Drill Dia.	OAL
1	1/8	3/64	1-1/4
2	3/16	5/64	1-7/8
3	1/4	7/64	2
4	5/16	1/8	2-1/8
5	7/16	3/16	2-3/4

SINGLE FLUTE COUNTERSINKS & SETS

- For portable and machine work when operated at comparatively high speeds
- Single flutes will countersink holes much smaller than multi-flute tools

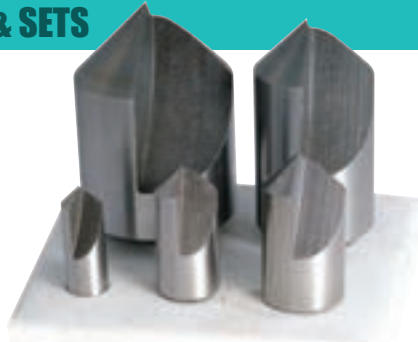

5 PC. SETS: 1/4, 3/8, 1/2, 3/4 & 1"

Degree	Item#	Price (F)
60°	2000-0030	53.14
82°	2000-0031	60.10
90°	2000-0032	62.50

HIGH SPEED STEEL

INDIVIDUAL(Inch), 82°

Diameter Body	End	Dia. of Shank	OAL Approx.	82° HSS Item#	Price (F)
1/4	1/32	1/4	2	2001-0250	4.70
3/8	1/32	1/4	2	2001-0375	7.57
1/2	1/32	1/4	2	2001-0500	10.30
5/8	1/32	3/8	2-1/4	2001-0625	12.30
3/4	1/8	1/2	2-3/4	2001-0750	19.14
1	1/8	1/2	2-3/4	2001-1000	28.99

HSS 82° 3-FLUTE COUNTERSINKS & SET

- Utilized in countersinking screw and rivet heads and for centering lathe work.
- 3-Flute eliminates chatter in most applications, while providing better accuracy than a single flute countersink.
- Set complete with wooden case.



HIGH SPEED STEEL

INDIVIDUALS

Diameter(Inch) Cutter	Shank	OAL Approx.	82° Item#	Price (F)
1/4	3/16	1-1/2	2001-1250	7.49
3/8	1/4	1-3/4	2001-1375	8.96
1/2	3/8	2	2001-1500	11.73
5/8	3/8	2-1/4	2001-1625	18.80
3/4	1/2	2-5/8	2001-1750	24.66
1	1/2	2-3/4	2001-2000	32.83

5 PC SET
1/4, 3/8, 1/2, 3/4 & 1"
2001-2005
\$79.25 (F)

5PC ZERO-FLUTE COUNTERSINK & DEBURRING TOOL SETS

- Cam relieved for totally chatter free cuts
- Through hole design that is easy to re-sharpen using a small grinding wheel in cross-hole
- Excels in aluminum, plastics and other nonmetallics

82°, 5 PC SET
2001-0006
\$64.35 (F)

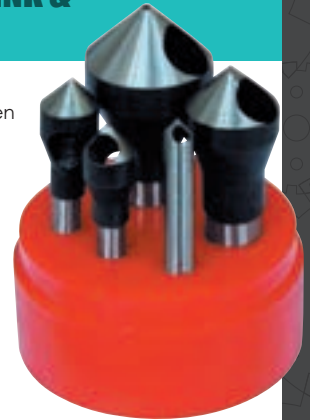

HIGH SPEED STEEL

5 PC INCLUDES

Size	Dia. Cut Range	Shank Diameter
0 double end	1/16~15/64"	1/4"
1 single end	5/32~13/32"	1/4"
2 single end	3/16~17/32"	1/4"
3 single end	5/16~25/32"	1/2"
4 single end	9/16~1-3/32"	1/2"

Item#	Degree	Price (F)
2001-0006	82°	64.35
2001-0007	90°	66.40

82° 6 FLUTE CHATTERLESS COUNTERSINKS & SET For Producing Machined Countersinks In Holes

- Right Hand.
- High speed steel.
- 6 fluted cutters with relatively short length for maximum rigidity.

8 PC SET
1/4, 5/16, 3/8, 1/2, 5/8, 3/4, 7/8 & 1"
2001-3001
\$131.95 (F)



INDIVIDUALS

Item#	Size	(Inch) Shank Dia.	Overall Length	Price (F)
2001-3187	3/16	3/16	1-1/2	6.63
2001-3250	1/4	1/4	1-1/2	5.99
2001-3312	5/16	1/4	1-3/4	7.13
2001-3375	3/8	1/4	1-3/4	8.63
2001-3500	1/2	1/4	2-1/8	11.60
2001-3625	5/8	1/2	2-3/8	12.82
2001-3750	3/4	1/2	2-11/16	21.61
2001-3875	7/8	1/2	2-13/16	24.47
2001-4000	1	1/2	2-13/16	29.26
2001-4250	1-1/4	3/4	3-3/8	48.72
2001-4500	1-1/2	3/4	3-1/2	73.95
2001-4750	1-3/4	1	4-1/4	94.11
2001-4999*	2	1	4-3/8	70.77

* Limited Supply

3 FLUTE METRIC SOLID PILOT COUNTERBORES - STRAIGHT SHANK

- Continuous pilot counterbores cut rapidly, smoothly and accurately, producing long spiraling chips rather than small metal particles.
- The pilot extends the full length of the flute portion of the tool.
- As cutter flutes are ground back due to wear, a new section of pilot becomes exposed.
- The pilot head may be cut off to any desired length when repeated sharpening make it too long for practical use.
- Continuous pilot counterbores have a life many times that of the conventional type counterbore.

HIGH SPEED STEEL



Cap Screw	Cutter Dia.	(mm) Pilot Dia.	Shank Dia.	OAL	Item#	Price (F)
M3	6.0	3.4	5.0	71	2007-0051	12.64
M3.5	6.5	3.7	5.0	71	2007-0053	14.33
M4	8.0	4.5	5.0	71	2007-0055	14.33
M5	10.0	5.5	8.0	80	2007-0057	15.11
M6	11.0	6.6	8.0	80	2007-0060	15.20
M8	15.0	9.0	12.5	100	2007-0062	20.02
M10	18.0	11.0	12.5	100	2007-0064	25.29
M12	20.0	13.5	12.5	100	2007-0066	26.13
M14	24.0	16.0	12.5	100	2007-0068	32.01

COUNTERBORES & SETS

40PC HSS COUNTERBORE SET Straight Shank • Interchangeable Pilot

- High speed steel.
- 3 Flutes.
- Straight shank



SET INCLUDES:

26 Pilots

- 3/32" Shank: 1/8, 5/32, 3/16 & 1/4"
- 5/32" Shank: 3/16, 7/32, 1/4, 9/32 & 5/16"
- 3/16" Shank: 1/4, 5/16, 3/8, 7/16 & 1/2"
- 1/4" Shank: 5/16, 3/8, 7/16, 1/2, 9/16 & 5/8"
- 5/16" Shank: 3/8, 7/16, 1/2, 9/16, 5/8 & 3/4"

13 Counterbores

- 1/4" thru 1" by 16ths.
- Supplied in fitted case.

40 PC SET
2007-0041
\$309⁰⁶
(F)

21PC INTERCHANGEABLE PILOT COUNTERBORE SET High Speed Steel • Straight Shank

SET INCLUDES:

14 Pilots (5/32" Shank):

- 0.187, 0.204, 0.213, 0.229, 1/4, 17/64, 9/32, 5/16, 21/64, 11/32, 3/8, 25/64, 13/32 & 7/16"

6 Counterbores (7/16" shank):

- 5/16, 3/8, 7/16, 1/2, 9/16 & 5/8"

1 Holder:

3/8" Straight Shank

1 Wood Case

- High speed steel.
- Straight shank
- 3 Flute.

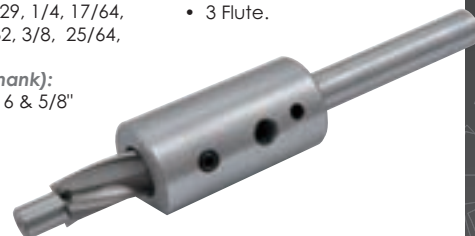

21 PC SET
2007-0023
\$108⁵⁰
(F)

2 FLUTE SOLID CAP SCREW COUNTERBORES



- High speed steel.
- Straight shank

FOR SOCKET HEAD CAP SCREWS

(Inch) Size	Pilot Size	Cutting Dia.	Shank Dia.	OAL	Item#	Price (F)
1/4	1/4	13/32	3/8	3-5/8	2007-0105	17.29
5/16	5/16	15/32	7/16	4	2007-0106	17.29
3/8	3/8	19/32	1/2	4-3/8	2007-0107	17.29
7/16	7/16	21/32	1/2	4-3/4	2007-0108	17.29
1/2	1/2	25/32	3/4	5-1/8	2007-0109	18.75

2MT SHANK - For 21PC Counterbore Set

- Morse taper #2 shank.
- Overall length: 135mm.
- Hole Diameter: 14mm.

2007-0022
\$26¹³
(F)



For use with our 21pc counterbore set, accepts 14mm shank counterbores.

3-FLUTE SOLID PILOT COUNTERBORES & SETS FOR SOCKET HEAD CAP SCREWS

- 3-Flute, straight shank
- Continuous pilot counterbores cut rapidly, smoothly and accurately, producing long spiraling chips rather than small metal particles
- The pilot extends the full length of the flute portion of the tool
- As cutter flutes are ground back due to wear, a new section of pilot becomes exposed
- The pilot head may be cut off to any desired length when repeated sharpening make it too long for practical use
- Continuous pilot counterbores have a life many times that of the conventional type counterbore.
- Set supplied with fitted wooden case.



HIGH SPEED STEEL



6 PC SET (1/4~3/4")
2007-0003
\$150¹⁵
(F)

1/4, 5/16, 3/8, 1/2, 5/8, 3/4"



7 PC SET (#6~1/2")
2007-0002
\$83⁷³
(F)

#6, 8, 10, 1/4, 5/16, 3/8, 1/2"

INDIVIDUALS

Cap Screw	Cutter Dia.	(Inch) Pilot Dia.	Shank Dia.	OAL	Item#	Price (F)
#6	.242	.150	7/32	3	2007-0006	9.69
#8	19/64	11/64	1/4	3	2007-0008	13.39
#10	21/64	13/64	5/16	3-1/2	2007-0010	13.62
1/4	13/32	9/32	3/8	3	2007-0016	15.26
5/16	1/2	11/32	7/16	5	2007-0020	15.18
3/8	19/32	13/32	1/2	6	2007-0024	17.47
1/2	25/32	17/32	3/4	7-1/2	2007-0032	19.79
5/8	31/32	21/32	3/4	7-1/2	2007-0033	24.44
3/4	1-3/16	13/16	1	8	2007-0034	28.11

REAMERS & STEP DRILLS

STRAIGHT SHANK HSS CHUCKING REAMERS

- ANSI standard.
- Suitable for production reaming of most materials.
- Used in general purpose through-hole applications.

Item#	Size	Flute Length	OAL	Price (F)
2006-3004	1/16	3/8	1-1/2	12.06
2006-3008	1/8	7/8	3-1/2	7.64
2006-3009	9/64	1	4	9.60
2006-3010	5/32	1	4	5.48
2006-3012	3/16	1-1/8	4-1/2	7.05
2006-3014	7/32	1-1/4	5	7.87
2006-3015	15/64	1-1/2	6	10.14
2006-3016	1/4	1-1/2	6	12.19
2006-3020	5/16	1-1/2	6	11.54
2006-3023	23/64	1-3/4	7	15.89
2006-3024	3/8	1-3/4	7	17.32
2006-3027	27/64	1-3/4	7	18.88
2006-3028	7/16	1-3/4	7	19.50
2006-3031	31/64	2	8	22.78
2006-3032	1/2	2	8	25.03
2006-3036	9/16	2	8	24.31
2006-3040	5/8	2-1/4	9	25.48
2006-3044	11/16	2-1/4	9	28.24
2006-3048	3/4	2-1/2	9-1/2	31.95
2006-3056	7/8	2-5/8	10	41.15
2006-3100	1	2-3/4	10-1/2	51.32

- Used for reaming holes without interrupted cuts.
- High speed steel
- Straight flute.
- 45 degree lead chamfer allows gradual starting load.
- Designed for use in drill presses, turret lathes, and screw machines.



Over-Under Reamers

Item #	Size	Flute Length	OAL	Price (F)
2006-3510	.1240	7/8	3-1/2	10.63
2006-3520	.1260	7/8	3-1/2	9.88
2006-3530	.1865	1-1/8	4-1/2	9.87
2006-3540	.1885	1-1/8	4-1/2	9.87
2006-3550	.2490	1-1/2	6	10.39
2006-3560	.2510	1-1/2	6	11.47
2006-3590	.3740	1-3/4	7	14.92
2006-3600	.3760	1-3/4	7	15.09
2006-3630	.4990	2	8	19.63
2006-3640	.5010	2	8	19.40

HSS CHUCKING REAMER SETS

- HIGH SPEED STEEL • STRAIGHT SHANK • STRAIGHT FLUTES

- Used in general purpose through-hole applications.
- Used for reaming holes without interrupted cuts.
- High speed steel.
- Straight shank.
- Straight flutes.

14 PC SET INCLUDES:
.1240, .1260, .1865, .1885,
.2490, .2510, .3115, .3135,
.3740, .3760, .4365, .4385,
.4995 & .5010"



14 PC SET
2006-0001
\$200³⁹
(E)
.1240 ~ .5010"

29 PC SET
2006-0011
\$359⁷⁷
(E)
1/16 ~ 1/2" x 64ths

HSS SPIRAL FLUTE TAPER PIPE REAMERS

- Right hand cut tapered 3/4" per foot.
- Designed for reaming holes to be tapped with American Standard Taper Pipe Taps (NPT).



HIGH SPEED STEEL • SPIRAL FLUTE

Item#	Size	(Inch)		Flute Length	Overall Length	Price (F)
		Large End Dia.	Small End Dia.			
2006-2014	1/16	.291	.245	3/4	2	8.79
2006-2018	1/8	.362	.316	3/4	2-1/8	11.83
2006-2026	1/4	.472	.406	1-1/16	2-7/16	15.57
2006-2034	3/8	.606	.540	1-1/16	2-9/16	21.97
2006-2042	1/2	.751	.665	1-3/8	3-1/8	26.68
2006-2058	3/4	.962	.876	1-3/8	3-1/4	37.64
2006-2074	1	1.212	1.103	1-3/4	3-3/4	60.59

SELF STARTING STEP DRILLS & SETS

- Made of high speed steel, heat treated and tempered for maximum strength.
- Requires no center punch to start drilling.
- Automatically deburrs drilled hole.

3 PC SET
5000-0889
\$72⁴⁶
(E)
INCLUDES: 1/8-1/2x1/32",
3/16-1/2x1/16", 1/4-3/4x1/16"

3 PC SET, TiN Coated
5000-0890
\$54¹⁵
(E)
INCLUDES: 1/8-1/2x1/32",
3/16-1/2x1/16", 1/4-3/4x1/16"



5000-0890 Shown



INDIVIDUALS

Hole Range	Step	Depth	Shank	Uncoated		TiN Coated	
				Item#	Price(E)	Item#	Price(E)
1/8~1/2x1/32"	13	1/8"	1/4"	5000-0013	12.46	5000-0500	21.78
3/16~1/2x1/16"	6	3/8"	1/4"	5000-0014	18.12	5000-0501	20.25
1/4~3/4x1/16"	9	1/8"	3/8"	5000-0015	18.89	5000-0750	22.56
3/16~7/8x1/16"	12	1/8"	3/8"	5000-0016	26.18	5000-0875	30.50
1/4~1-3/8x1/8"	10	1/8"	1/2"	5000-0017	49.00	5000-0876	52.61

REAMERS & SETS

VALUE HSS ADJUSTABLE BLADE REAMERS & SETS

- Adjustable blade lets you handle multiple hole sizes with a single tool and multiple tools in each set let you handle even more hole sizes, making these sets virtually indispensable. Reamers are hardened, precision-ground high speed steel with a black oxide finish and include a wood storage box.
- Ends are center drilled so blades can be sharpened in place.
- Blades are adjusted by loosening one nut and tightening the other.
- Each reamer expands to the next size.
- Adjustable blades give the operator the ability to handle multiple hole sizes with a single tool, making them a good choice for users with low volume reaming needs.
- Square end allows the user to turn the reamer by hand with an adjustable wrench or straight handle tap wrench.

HIGH SPEED STEEL



2006-9120 Shown



2006-9123 Shown



2006-9125 Shown

SETS

Range	No. of Pieces	Capacity Range	Item#	Price (F)
#4/A - 2/A	3	3/8~15/32"	2006-9120	28.60
#8/A - 2/A	7	1/4~15/32"	2006-9123	48.60
A - F	6	15/32~27/32	2006-9125	68.20

STRAIGHT FLUTE REAMERS SHOULD BE USED IN THRU-HOLE APPLICATIONS ONLY



INDIVIDUALS

Item#	Size	Range	OAL	Price (F)
2006-9170	#8/A	1/4 to 9/32	3-1/4	6.51
2006-9172	#7/A	9/32 to 5/16	3-1/2	6.51
2006-9173	#6/A	5/16 to 11/32	4-1/8	6.51
2006-9174	#5/A	11/32 to 3/8	4-3/8	6.51
2006-9175	#4/A	3/8 to 13/32	4-3/4	6.79
2006-9176	#3/A	13/32 to 7/16	5	7.03
2006-9177	#2/A	7/16 to 15/32	5-1/4	7.32
2006-9178	A	15/32 to 17/32	5-1/2	7.84
2006-9179	B	17/32 to 19/32	5-3/4	8.60
2006-9180	C	19/32 to 21/32	6-1/2	9.12
2006-9181	D	21/32 to 23/32	6-3/4	9.41
2006-9182	E	23/32 to 25/32	7	10.17
2006-9183	F	25/32 to 27/32	7-3/8	12.26
2006-9184	G	27/32 to 15/16	8	13.30
2006-9185	H	15/16 to 1-1/16	9	14.63
2006-9186	I	1-1/16 to 1-3/16	10	17.77
2006-9187	J	1-3/16 to 1-11/32	11	22.99
2006-9188	K	1-11/32 to 1-1/2	12	30.54
2006-9189	L	1-1/2 to 1-13/16	14	46.50
2006-9190	M	1-13/16 to 2-7/32	16	63.46

HIP HSS ADJUSTABLE BLADE REAMERS & SETS

- Adjustable blade lets you handle multiple hole sizes with a single tool and multiple tools in each set let you handle even more hole sizes, making these sets virtually indispensable. Reamers are hardened, precision-ground high speed steel with a black oxide finish and include a wooden storage box.
- Ends are center drilled so blades can be sharpened in place.
- Blades are adjusted by loosening one nut and tightening the other.
- Each reamer expands to the next size.
- Adjustable blades give the operator the ability to handle multiple hole sizes with a single tool, making them a good choice for users with low volume reaming needs.
- Square end allows the user to turn the reamer by hand with an adjustable wrench or straight handle tap wrench.

HIGH SPEED STEEL



2006-0024 Shown

2006-0026 Shown

2006-0028 Shown

Size	Set	Capacity Range	Item#	Price (F)
#8/A - 5/A	4	1/4~3/8"	2006-0024	63.12
A-H(15/32~1-1/16")	8	15/32~1-1/16"	2006-0026	229.84
A-K(15/32~1-1/2")	11	15/32~1-1/2"	2006-0028	429.64

STRAIGHT FLUTE REAMERS SHOULD BE USED IN THRU-HOLE APPLICATIONS ONLY



INDIVIDUALS

Item#	Size	Range	OAL	Price (F)
2006-0070	#8/A	1/4 to 9/32	3-1/4	25.46
2006-0072	#7/A	9/32 to 5/16	3-1/2	22.77
2006-0073	#6/A	5/16 to 11/32	4-1/8	22.65
2006-0074	#5/A	11/32 to 3/8	4-3/8	24.10
2006-0075	#4/A	3/8 to 13/32	4-3/4	32.16
2006-0076	#3/A	13/32 to 7/16	5	29.26
2006-0077	#2/A	7/16 to 15/32	5-1/4	29.94
2006-0078	A	15/32 to 17/32	5-1/2	27.59
2006-0079	B	17/32 to 19/32	5-3/4	27.63
2006-0080	C	19/32 to 21/32	6-1/2	28.20
2006-0081	D	21/32 to 23/32	6-3/4	27.95
2006-0082	E	23/32 to 25/32	7	27.95
2006-0083	F	25/32 to 27/32	7-3/8	28.62
2006-0084	G	27/32 to 15/16	8	32.85
2006-0085	H	15/16 to 1-1/16	9	34.09
2006-0086	I	1-1/16 to 1-3/16	10	43.94
2006-0087	J	1-3/16 to 1-11/32	11	53.30
2006-0088	K	1-11/32 to 1-1/2	12	62.76
2006-0089	L	1-1/2 to 1-13/16	14	82.71
2006-0090	M	1-13/16 to 2-7/32	16	148.28

REPAIRMAN'S TAPER REAMER



RANGE(SMALL END~LARGE END): 1/8~5/8"

- Removes burrs from small holes, tubing, etc.
- Enlarges holes in soft metals, plastics and similar materials.
- Number of Flutes: 7
- Sliding T-Handle length: 3.5"
- Overall Length: 5"

2006-9001
\$908
(F)

SPIRAL POINT TAPS-Plug Type

**GROUND FROM SOLID
FOR THROUGH HOLES**



GROUND THREAD, HIGH SPEED STEEL

Item#	Size	H Limit/Flute	Price(E)	Item#	Size	H Limit/Flute	Price(E)	Item#	Size	H Limit/Flute	Price(E)
1011-6004	0~80NF	H-2/2	4.91	1011-6044	8~32NC	H-3/2	4.06	1011-6122	1/2"~13NC	H-3/3	14.01
1011-6006	1~64NC	H-1/2	4.68	1011-6048	8~36NF	H-2/2	4.64	1011-6126	1/2"~20NF	H-3/3	13.14
1011-6012	1~72NF	H-2/2	4.68	1011-6050	10~24NC	H-2/2	5.04	1011-6130	9/16"~12NC	H-3/3	12.64
1011-6014	2~56NC	H-2/2	4.24	1011-6058	10~32NF	H-3/2	4.32	1011-6136	9/16"~18NF	H-3/3	13.53
1011-6016	2~64NF	H-2/2	3.94	1011-6062	12~24NC	H-3/2	4.55	1011-6138	5/8"~11NC	H-3/3	17.71
1011-6018	3~48NC	H-2/2	4.95	1011-6064*	12~28NF	H-3/2	2.76	1011-6142	5/8"~18NF	H-3/3	17.76
1011-6020	3~56NF	H-2/2	5.14	1011-6074	1/4"~20NC	H-3/3	4.24	1011-6146	11/16"~11NS	H-3/3	19.89
1011-6022	4~40NC	H-2/2	4.20	1011-6078	1/4"~28NF	H-3/3	4.24	1011-6148	11/16"~16NS	H-3/3	20.16
1011-6026	4~48NF	H-2/2	4.32	1011-6094	5/16"~18NC	H-3/3	6.55	1011-6150	3/4"~10NC	H-3/3	26.16
1011-6028	5~40NC	H-2/2	3.77	1011-6102	5/16"~24NF	H-3/3	6.73	1011-6154	3/4"~16NF	H-3/3	25.13
1011-6032	5~44NF	H-2/2	3.76	1011-6106	3/8"~16NC	H-3/3	8.59	1011-6160	7/8"~9NC	H-4/4	34.20
1011-6036	6~32NC	H-3/2	4.43	1011-6112	3/8"~24NF	H-3/3	8.26	1011-6164	7/8"~14NF	H-4/4	36.37
1011-6040	6~40NF	H-2/2	3.87	1011-6114	7/16"~14NC	H-3/3	10.40	1011-6168	1"~8NC	H-4/4	56.03
1011-6042	8~32NC	H-2/2	4.64	1011-6120	7/16"~20NF	H-3/3	9.11	1011-6170	1"~12NF	H-4/4	54.45

* Limited Supply

SPIRAL FLUTE TAPS - Bottom Type

GROUND THREAD, HIGH SPEED STEEL



**FOR BLIND HOLES
GROUND FROM SOLID**

Item#	Size	H Limit/Flute	Price (E)
1011-8505	4-40NC	H-2/2	4.68
1011-8513	6-32NC	H-3/2	4.76
1011-8517	8-24NC	H-3/2	4.68
1011-8518	8-32NC	H-3/2	5.04
1011-8609	10-24NC	H-3/2	4.81
1011-8610	10-32NF	H-3/2	5.20
1011-8613	1/4"~20NC	H-3/3	4.78
1011-8614	1/4"~28NF	H-3/3	6.21
1011-8615	5/16"~18NC	H-3/3	7.65
1011-8616	5/16"~24NF	H-3/3	8.29
1011-8617	3/8"~16NC	H-3/3	9.10
1011-8618	3/8"~24NF	H-3/3	6.79
1011-8621	1/2"~13NC	H-3/3	14.50
1011-8622	1/2"~20NF	H-3/3	14.07
1011-8626	5/8"~11NC	H-3/3	17.29
1011-8627*	5/8"~18NF	H-3/3	10.64
1011-8628	3/4"~10NC	H-3/3	26.98
1011-8629	3/4"~16NF	H-3/3	27.46

* Limited Supply

METRIC SPIRAL POINT TIN COATED TAPS-Plug

GROUND FROM SOLID

- Spiral point.
- Metric DIN 371.
- High speed steel.
- Titanium coated.
- Thread ground.



FOR THROUGH HOLES

Item#	Size	Limit	Price(E)
1011-7700	M2-0.4	D3	9.78
1011-7699	M2.5-0.45	D3	4.55
1011-7701	M3-0.5	D3	7.57
1011-7702	M4-0.7	D4	6.70
1011-7703	M5-0.8	D4	7.22
1011-7704	M6-1.0	D5	7.92
1011-7705	M8-1.25	D5	8.74
1011-7706	M10-1.25	D5	11.28
1011-7707	M10-1.50	D6	11.38
1011-7708	M12-1.75	D6	13.65

METRIC 35° SPIRAL FLUTE TIN COATED TAPS-Bottom

GROUND FROM SOLID

- 35° Spiral flute.
- Metric DIN 371.
- High speed steel.
- Titanium coated.
- Thread ground.



FOR BLIND HOLES

Item#	Size	Limit	Price(E)
1011-7752	M2-0.4	D3	10.17
1011-7750	M2.5-0.45	D3	8.16
1011-7753	M3-0.5	D3	6.73
1011-7754	M4-0.7	D4	8.16
1011-7755	M5-0.8	D4	7.67
1011-7756	M6-1.0	D5	9.46
1011-7758	M8-1.25	D5	9.72
1011-7759	M10-1.25	D5	10.17
1011-7760	M10-1.50	D6	11.83
1011-7762	M12-1.75	D6	15.08

STANDARD HAND TAPS

**HIGH SPEED STEEL
GROUND THREAD
GROUND FROM THREAD**



Limited Supply!

TAPER: 7-10 THREAD CHAMFER
PLUG: 3-5 THREAD CHAMFER
BOTTOM: 1-2 THREAD CHAMFER

Size	No. of Flutes	Thread Limit	Taper Item#	Price (F)	Bottom Item#	Price (F)	Plug Item#	Price (F)
4-40NC	3	H2	1012-0440	2.62	1014-0440	2.66	-----	-----
6-32NC	3	H3	-----	-----	-----	-----	1013-0632	2.31
8-32NC	3	H3	1012-0832	2.29	1014-0832	2.38	1013-0832	2.38
10-24NC	4	H3	-----	-----	1014-1024	2.53	1013-1024	2.53
10-32NF	4	H3	1012-1032	2.46	1014-1032	2.42	1013-1032	2.46
1/4-20NC	4	H3	1012-2520	2.68	-----	-----	1013-2520	2.68
1/4-28NF	4	H3	1012-2528	2.62	1014-2528	2.60	-----	-----
5/16-18NC	4	H3	1012-3118	3.87	-----	-----	-----	-----
3/8-16NC	4	H3	1012-3716	4.31	1014-3716	4.31	-----	-----
3/8-24NF	4	H3	-----	-----	1014-3717	3.46	-----	-----
7/16-20NF	4	H3	1012-4320	5.26	1014-4320	4.86	1013-4320	4.86
1/2-13NC	4	H3	1012-5013	8.32	1014-5013	8.32	1013-5013	8.32
1/2-20NF	4	H3	1012-5020	8.32	1014-5020	8.32	1013-5020	8.32

TAPER PIPE (NPT) TAPS

- Cuts internal threads in pipes.
- Ideal for pipe fitting
- Tapered at a rate of 3/4" per foot.



THREAD GROUND • HIGH SPEED STEEL

Size	No. of Flutes	Thread Length	Overall Length	HSS		TIN Coated	
				Item#	Price (E)	Item#	Price (E)
1/16~27	4	11/16	2-1/8	-----		1011-3305	11.21
1/8~27	4	3/4	2-1/8	1011-3211	10.51	1011-3310	10.26
1/4~18	4	1-1/16	2-1/8	1011-3215	13.58	1011-3315	17.00
3/8~18	4	1-1/16	2-7/16	1011-3220	16.73	1011-3320	18.68
1/2~14	4	1-3/8	2-9/16	1011-3225	24.69	1011-3325	21.11
3/4~14	5	1-3/8	3-1/8	1011-3230	34.90	1011-3330	43.88
1~11-1/2	5	1-3/4	3-1/4	1011-3235	60.05	1011-3335	65.93
1-1/4~11-1/2	5	1-3/4	3-1/4	1011-3240*	79.58	-----	
1-1/2~11-1/2	7	1-3/4	4	1011-3245*	106.26	-----	

* Limited Supply



TAPER PIPE (NPT) TAP SETS



- Cuts internal threads in pipes.
- Ideal for pipe fitting
- Tapered at a rate of 3/4" per foot.

THREAD GROUND • HIGH SPEED STEEL

3 PC SET
1011-3303
\$426⁹⁷
(E)

1-1/4~11-1/2, 1-1/2~11-1/2, 2~11-1/2

6 PC SET
1011-3306
\$412⁸³
(E)

1/4~18, 3/8~18, 1/2~14, 3/4~14, 1~11-1/2, 1-1/4~11-1/2

HEXAGON PIPE (NPT) DIES

- Ideal for cutting right-hand external pipe threads.
- Hex head shape die is designed for use in die stocks or adjustable wrenches.
- Each NPT tap & die is etched with the size for easy reference.
- Supplied with solid wooden case.
- Includes one of each of the following NPT tap & dies: 1/8~27, 1/4~18, 3/8~18, 1/2~14, 3/4~14 & 1~11-1/2

THREAD GROUND • HIGH SPEED STEEL

12 PC Set
Range 1/8 ~ 1"
1011-3312
\$348⁸⁷
(F)



HEXAGON PIPE (NPT) DIES

- Ideal for cutting right-hand external pipe threads.
- Hex head shape die is designed for use in die stocks or adjustable wrenches.
- Each NPT die is etched with the size for easy reference.

CARBON STEEL, RIGHT HAND

Size	Item#	Price (F)
1/8~27	1017-1800	5.40
1/4~18	1017-1802	6.68
3/8~18	1017-1804	9.45
1/2~14	1017-1806	11.42
3/4~14	1017-1808	18.41
1~11-1/2	1017-1810	25.58



6PC TAPER PIPE (NPT) TAP & DIE SET

- Right hand NPT pipe thread.
- For use in hand operations.
- Made of carbon steel.
- Tap Chamfer: 2-3 threads.
- Die Chamfer: 1.5 threads.
- Supplied with fitted case.

6 PC SET
1011-3313
\$340²
(F)



6PC set includes one of each tap & die: 1/4~18, 3/8~18, 1/2~14

7PC HEXAGON RETHREADING DIE SET Metric

- Right hand.
- Supplied with fitted metal case.

7pc Includes:

M6x1.00, M8x1.25, M10x1.50, M12x1.75,
M14x2.00, M16x2.00 & M20x2.50

CARBON STEEL

Range M6 ~ M20
1017-0007
\$3328
(F)



HEX RETHREADING DIES



CARBON STEEL, RIGHT HAND

Size	Item#	Price (F)
1/4~20	1017-1717	3.76
1/4~28	1017-1718	3.69
5/16~18	1017-1719	3.70
5/16~24	1017-1720	3.76
3/8~16	1017-1721	4.73
3/8~24	1017-1722	4.84
7/16~14	1017-1723	5.56

Size	Item#	Price (F)
7/16~20	1017-1724	5.43
1/2~13	1017-1725	6.12
1/2~20	1017-1726	6.12
9/16~12	1017-1727	6.12
9/16~18	1017-1728	6.12
5/8~11	1017-1729	6.64
5/8~18	1017-1730	6.68
3/4~10	1017-1733	8.65
3/4~16	1017-1734	8.69
1~8	1017-1737	15.23
1~14	1017-1739	15.23

16PC HEXAGON RETHREADING DIE SET

- Right hand.
- Supplied with fitted metal case.

16pc Includes:

1/4~20, 1/4~28, 5/16~18,
5/16~24, 3/8~16, 3/8~24,
7/16~14, 7/16~20, 1/2~13,
1/2~20, 9/16~12, 9/16~18,
5/8~11, 5/8~18,
3/4~10 & 3/4~16.

CARBON STEEL

Range 1/4 ~ 3/4"
NC&NF
1017-0016
\$6864
(F)



20PC HEXAGON RETHREADING DIE SET

- Right hand.
- Supplied with fitted metal case.

CARBON STEEL

20pc Includes:

1/4~20, 1/4~28, 5/16~18,
5/16~24, 3/8~16, 3/8~24,
7/16~14, 7/16~20, 1/2~13,
1/2~20, 9/16~12, 9/16~18,
5/8~11, 5/8~18, 3/4~10,
3/4~16, 7/8~9, 7/8~14,
1~8 & 1~14.

Range 1/4 ~ 1"
NC&NF
1017-0020
\$13027
(F)



ADJUSTABLE HSS ROUND SPLIT DIES

HIGH SPEED STEEL,
RIGHT HAND

- Adjustable with screw

13/16" O.D.

Size	Item#	Price (F)
4~40	1016-1014	4.61
5~40	1016-1018	6.12
6~32	1016-1022	5.40
6~40	1016-1024	5.68
8~32	1016-1026	5.24
8~36	1016-1027	5.10
10~24	1016-1030	5.22
10~32	1016-1032	5.76
1/4~20	1016-1040	6.09
1/4~28	1016-1042	6.12
5/16~18	1016-1044*	2.86
5/16~24	1016-1045*	2.86

1" O.D.

Size	Item#	Price (F)
6~32	1016-1122	8.40
6~40	1016-1124	8.16
8~32	1016-1126*	3.65
8~36	1016-1128*	4.14
10~24	1016-1130	7.10
10~32	1016-1132	8.72
1/4~20	1016-1140	7.52
1/4~28	1016-1142	7.98
5/16~18	1016-1144	7.70
5/16~24	1016-1146	7.52
3/8~16	1016-1148	7.52
3/8~24	1016-1150	8.15
7/16~14	1016-1152	8.24
7/16~20	1016-1154	8.24
1/2~13	1016-1156	8.16
1/2~20	1016-1158	7.64

1-1/2" O.D.

Size	Item#	Price (F)
1/4~20	1016-1240*	18.97
1/4~28	1016-1242*	18.97
5/16~18	1016-1244*	18.97
5/16~24	1016-1246*	18.97
3/8~16	1016-1248*	19.84
3/8~24	1016-1250*	18.97
7/16~14	1016-1252*	18.99
7/16~20	1016-1254*	18.99
1/2~13	1016-1258*	20.79
1/2~20	1016-1260*	18.99
9/16~12	1016-1262*	20.48
9/16~18	1016-1264*	18.99
5/8~11	1016-1266*	19.80
5/8~18	1016-1268*	18.99
3/4~10	1016-1270*	20.79
3/4~16	1016-1272*	18.99



* Limited Supply

2" O.D.

Size	Item#	Price (F)
3/8~16	1016-1348*	35.41
1/2~13	1016-1356*	35.41
5/8~11	1016-1364*	35.41
3/4~10	1016-1368*	35.41
7/8~9	1016-1372*	19.80
1~8	1016-1378*	35.19

TAP & DIE SETS

24PC TUNGSTEN STEEL TAP & DIE SET WITH RATCHETING WRENCH



- SAE, NC threads
- Ratcheting tap & die wrench
- 1" O.D. die adapter
- Locking tap adapter (for big taps)
- T-handle tap wrench (for small taps) fits in ratcheting wrench
- Fitted metal case.

24 PC SET
#6~1/2"
1011-0124
\$56⁹²
(E)

TUNGSTEN STEEL

Limited Supply!

Set	Range	Taps	Dies	Ratchet Wrench	T-handle Wrench	Tap Adapter	Die Adapter	Screw Driver
	#6 ~ 1/2"							
24pc	6-32, 8-32, 10-24, 12-24, 1/4-20, 5/16-18, 3/8-16, 7/16-14, 1/2-13	9	9	1	1	1	1	1

41PC TUNGSTEN STEEL TAP & DIE SETS

- Hexagon shape dies
- Packed in fitted durable & attractive plastic case with index marked.
- **Tungsten steel.**

TUNGSTEN STEEL



Range: #4-1/2" Size and Threads per inch	Screw Pitch	Taps	Dies	Die Stock	"T" Holder	Tap & Reamer Wrench	Screw Driver
NC 4~40, 6~32, 8~32, 10~24, 12~24, 1/4~20, 5/16~18, 3/8~16, 7/16~14, 1/2~13							
NF 10~32, 1/4~28, 5/16~24, 3/8~24, 7/16~20, 1/2~20	1	17	17	1	2	1	1
NPT 1/8"-27R							
Range: 3mm-12mm							
3 x 0.50 6 x 0.75 10 x 1.25							
3 x 0.60 6 x 1.00 10 x 1.50							
4 x 0.70 7 x 0.75 12 x 1.50	1	17	17	1	2	1	1
4 x 0.75 7 x 1.00 12 x 1.75							
5 x 0.80 8 x 1.00							
5 x 0.90 8 x 1.25 NPT-1/8"-27							

Range 3~12mm
1011-0005
\$73¹⁹
(F)

Range #4~1/2"
1011-0004
\$73¹⁹
(F)

45PC TUNGSTEN STEEL TAP & DIE SETS

- Ideal set for any situation.
- Packed in fitted durable & attractive plastic case with index marked.
- **Tungsten steel.**

TUNGSTEN STEEL



Range 1/4"-1"
1011-0001
\$159⁵⁸
(F)

Range 6~24mm
1011-0002
\$159⁵⁸
(F)

TiN COATED
Range 1/4"-1"
1011-0003
\$196⁰⁸
(F)

Range: 1/4" - 1" Size and Threads per inch	Taps	Dies	Die Stock	"T" Holder	Screw Driver
NC 1/4~20, 5/16~18, 3/8~16, 7/16~14, 1/2~13, 1~1/2" O.D. 9/16~12, 5/8~11, 3/4~10, 7/8~9, 1~8	20	20	2	2	1
NF 1/4~28, 5/16~24, 3/8~24, 7/16~20, 1/2~20					
2" O.D. 9/16~18, 5/8~18, 3/4~16, 7/8~14, 1~14					
Range: 6mm-24mm					
6 x 0.75 12 x 1.75 20 x 1.50					
6 x 1.00 14 x 1.50 20 x 2.50					
8 x 1.00 14 x 2.00 22 x 1.50					
8 x 1.25 16 x 1.50 22 x 2.50	20	20	2	2	1
10 x 1.25 16 x 2.00 24 x 1.50					
10 x 1.50 18 x 1.50 24 x 3.00					
12 x 1.50 18 x 2.50					

110PC CARBON STEEL TAP & DIE COMBO SET

- SAE, NC, NF, NS threads
- Metric, International, Special
- American National Pipe, NPT, NPS
- 1" O.D. die stock
- 1-1/2" O.D. die stock
- No. 4 adjustable tap wrench
- No. 6 adjustable tap wrench
- T-handle tap wrench
- **Material: Carbon Steel**

Range #4~3/4" & 6~18mm

1011-0111
\$279⁵³
(F)

CARBON STEEL

INCLUDES:

1 taper tap, 1 bottoming tap and die in each of the following sizes:
4-40, 6-32, 8-32, 10-24, 12-24, 10-32, 1/4-20, 1/4-24, 1/4-28, 1/4-40, 5/16-18, 5/16-24, 3/8-16, 3/8-24, 7/16-14, 7/16-20, 1/2-13, 1/2-20, 9/16-12, 9/16-18, 5/8-11, 5/8-18, 3/4-10, 3/4-16, 1/8-27NPT, 1/4-18NPT, M6x1.0, M8x1.25, M10x1.0, M10x1.5, M11x1.5, M12x1.25, M12x1.75, M14x1.25 & M18x1.5



22PC HSS Tap & Die Set -Inch

- Made of High Speed Steel.
- Wooden case included.

INCLUDES:

1/4-20, 1/4-28, 5/16-18, 5/16-24, 3/8-16, 3/8-24, 7/16-14, 7/16-20, 1/2-13, 1/2-20 Plug Tap and Die each, 1" OD Adjustable Die Stock, T-Handle Tap Wrench.

HIGH SPEED STEEL

Range 1/4 ~ 1/2"
1011-0007
\$162⁷⁸
(F)

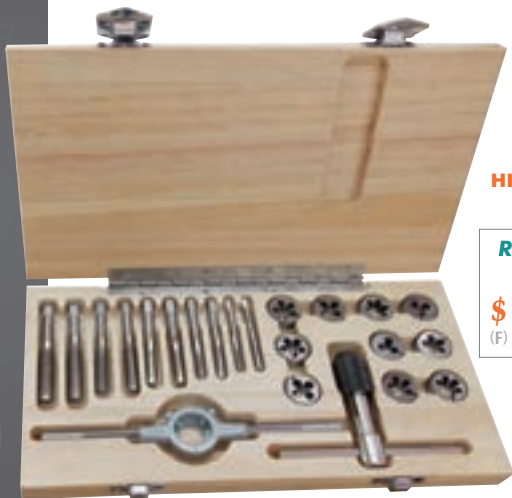

44PC HSS Tap & Die Set -Metric

- Made of High Speed Steel.
- Wooden case included.

HIGH SPEED STEEL

INCLUDES:

20 Sizes Tap & Die Each: M2x0.4, M2.5x0.45, M3x0.50, M4x0.70, M5x0.80, M6x1.0, M7x1.0, M8x1.0, M8x1.25, M10x1.0, M10x1.25, M10x1.5, M12x1.0, M12x1.25, M12x1.50, M12x1.75, M14x1.5, M14x2.0, M16x2.0, M18x1.5, 1" & 1-1/2" OD (M14-M18) Adjustable Die Stock, 2 Tap Wrench.

Range M2 ~ M18
1011-0009
\$403⁴³
(F)



110PC HSS TAP & DIE COMBO SET

- SAE, NC, NF, NS threads
- Metric, International, Special
- American National Pipe, NPT, NPS
- 1" O.D. die stock
- 1-1/2" O.D. die stock
- No. 4 adjustable tap wrench
- No. 6 adjustable tap wrench
- T-handle tap wrench

Range #4~3/4" & 6~18mm

1011-0110
\$975⁹⁴
(E)

HIGH SPEED STEEL

INCLUDES:

1 taper tap, 1 bottoming tap and die in each of the following sizes:
4-40, 6-32, 8-32, 10-24, 12-24, 10-32, 1/4-20, 1/4-24, 1/4-28, 1/4-32, 5/16-18, 5/16-24, 3/8-16, 3/8-24, 7/16-14, 7/16-20, 1/2-13, 1/2-20, 9/16-12, 9/16-18, 5/8-11, 5/8-18, 3/4-10, 3/4-16, 1/8-27NPT, 1/4-18NPT, M6x1.0, M8x1.25, M10x1.0, M10x1.5, M11x1.5, M12x1.25, M12x1.75, M14x1.25 & M18x1.5



TAPPING ACCESSORIES

TAP GUIDE TOOL-SPRING CENTERED

- Spring centered tap guide tool to align tap for threading, lathe, mill or jig bore.
- Point hardened upto 50-55 HRC
- Shank Diameter: 1/2"
- For use with drill chucks to stroke the hardened point for accurate hand topped thread.

NEW



TIPS:

The center's body should be gripped in a drill chuck or collet, while the hardened point is inserted into the middle of the tapping handle. The stroke of the center will follow the tap, assuring straight and accurate hand tapped threads. One universal size for all tapping applications.

3906-0220
\$780
 (F)

60PC HSS METRIC/INCH TAP & DIE SET

- NC, NF and NPT threads
- 1" O.D, dies
- Adjustable die stock
- Adjustable handle tap wrench
- T-handle tap wrench
- Screwdriver
- Two screw pitch gages

NEW



CARBON STEEL

60PC SET
1011-0106
\$11595
 (F)

INCLUDES:

27 tap & die sizes: 1/4-20NC, 5/16-18NC, 3/8-16NC, 7/16-14NC, 1/2-13NC, 4-40NC, 6-32NC, 8-32NC, 10-24NC, 12-24NC, 1/4-28NF, 5/16-24NF, 3/8-24NF, 7/16-20NF, 1/2-20NF, 10-32NF, 1/8-27NPT, 3mmx0.5, 4mmx0.7, 5mmx0.8, 6mmx1.0, 7mmx1.0, 8mmx1.25, 9mmx1.25, 10mmx1.5, 10mmx1.0, and 12mmx1.75.

COMPACT HAND TAPPER ON MAG BASE

- Compact and portable.
- Suitable for large workpieces like machine cases & thin plate tapping jobs.
- Max. stroke 2.36".
- Drill chuck enables the tap to be easily loaded and taken off.
- Powerful permanent magnet (175 lbs.) seat with On/Off switch.
- Mag. base dimensions: 2.36x2.36x2"

MADE IN TAIWAN



Tap & Round Iron Piece Not Included

Tap Capacity
M3-M12
3900-0255
\$21706
 (E)



RATCHET T-HANDLE TAP HOLDERS & SET

- Ratcheting type.
- This tap holder is made of tool steel, hardened and ground.
- Can be used for holding taps, reamers.

3 PC SET
#0-1/2"
3900-0240
\$4658
 (F)



Item#	Body Length	Capacity for Tap		Price (F)
		Size	Square Shank	
3900-0241	2-1/8"	1/16-3/16"	1/16-5/32"	15.53
3900-0245	2-5/8"	7/32-7/16"	5/32-1/4"	18.95
3900-0248	3-1/2"	1/4-1/2"	3/16-5/16"	23.49

TAP WRENCH EXTENTIONS

- High-quality precision tap extensions.
- Two-jaw chuck.



Item#	Tap Capacity	Length	Shank	Price (F)
3900-0218	#0 ~ 12	7"	3/8"	12.47
3900-0219	#12 ~ 1/2"	10-3/4"	1/2"	16.47

MACHINE TAPPING GUIDE

- Provide sensitive feel for hand tapping small holes on mills and drill presses
- Starts every hole straight and prevents tap breakage
- Shank dia. 3/8"
- Handle dia. 1"
- Tap capacity #0-12

3900-0220
\$1261
 (F)



HAND TAPPER ON MAG BASE



- Compact and portable design, easy to operate.
- Guide bar helps the tap positioning precisely.
- Evenly force delivering during operation prevent tap from breaking.
- Quick chuck enables the tap to be easily loaded and took off.
- Powerful permanent magnet seat with On/Off switch.

Tap Capacity 0-1/2"
3900-0254
\$37206
 (E)

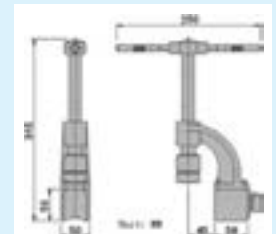

MADE IN TAIWAN

ADJUSTABLE TAP & REAMER WRENCHES & SET

- Knurled steel handles.
- Jaws surface hardened.
- Zinc die casting.

4 PC SET
#0, 1-1/2, 3, 4
3900-0236
\$51.40
(F)



Item#	Size	Range For Hand Taps	Range For Pipe Taps	OAL	Price (F)
3900-0209	#0	0~1/4"	None	5"	4.56
3900-0210	#1-1/2	1/16~1/2"	None	7"	5.85
3900-0232	#2	1/64~15/32"	1/8"	11"	10.64
3900-0211	#3	3/16~3/4"	1/8~3/8"	15"	18.00
3900-0235	#4	1/4~1-1/8"	1/8~3/4"	19"	34.00
3900-0237	#5	1/2~1-1/4"	1/4~1"	30"	45.25

4PC HEAVY DUTY ADJUSTABLE TAP & REAMER WRENCH SET

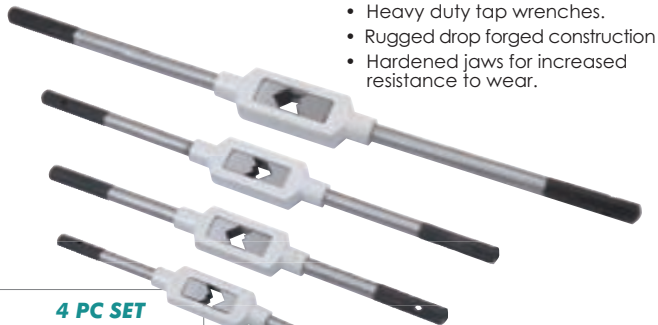

- Heavy duty tap wrenches.
- Rugged drop forged construction
- Hardened jaws for increased resistance to wear.

4 PC SET
1/4~3/4"
3906-0240
\$42.06
(F)

4PC Capacity Includes (range for hand taps):
1/16~1/4"(M2~M6), 1/16~3/8"(M2~M10)
5/32~1/2"(M6~M12) & 5/32~3/4"(M6~M22)

SELF-ALIGNING TAP & REAMER HOLDERS



- Base of guide has two 120° Vees, which accepts round parts.
- New 4 jaw design provides firm grip and 90° alignment, eliminates tap breakage while producing perfectly aligned threads.

Tap Range: 0~#8
3900-0291
\$22.15
(F)

NEW DESIGN
Tap Range 0~1/2"
(2 Collets-0~#8 & #10~1/2")
3900-0293
\$40.20
(F)



DIE STOCKS

- For adjustable round split dies
- Designed to accommodate round screw adjustable dies



INDIVIDUALS

Item#	Size No.	Die O.D.	Length	Price (F)
3900-0225	2	13/16"	6-1/2"	3.89
3900-0226	3	1"	8-1/2"	5.51
3900-0227	5	1-1/2"	12"	11.47
3900-0228	6	2"	15"	16.76
3900-0229	7	2-1/2"	19"	34.26

4 PC SET
3900-0233
\$42.19
(F)
No. 2, 3, 5 & 6

3PC FLOATING DIE HOLDER SET

- One piece construction
- Total length 3"

Die Dia.	Body D x Length	Shank
13/16	1-1/2"x1	1/2
1	1-1/2"x1	1/2
1-1/2	2"x 1-1/4	3/4

3900-0223
\$58.08
(F)

IDEAL FOR SHORT OR MEDIUM-RUN THREADING OF SHAFTS !



MORSE TAPER TAILSTOCK DIE HOLDER SETS

- The set includes tapered Shank, Pin Punch & 4 sizes of Die Holders.
- Completely interchangeable to fit tapered shank with the help of a pin which allows about 1-1/2" travel.
- Easy knock out pin with a pin punch.
- Tang end.



Item#	Taper	Die Holder Size	Price (F)
3906-4910	MT 2	13/16, 1, 1-5/16 & 1-1/2"	57.36
3906-4911	MT 3	13/16, 1, 1-5/16 & 1-1/2"	61.78

SPRING-LOADED TAP GUIDES

- Adjustable tension spring
- Reversible tension pin for male and female hole centering or tapping
- 1/2" dia. hardened shank, knurled for easy handling
- 3/16" dia. hardened tension pin

FOR DRILL PRESSES & MILLS



VALUE
3906-0215
\$68.4
(F)

HHIP
3900-0215
\$84.8
(F)

SELF REVERSING TAPPING HEAD SETS

- Adjustable torque prevents damage and tap breakage.
- High reverse ratio increases productivity.
- Jacobs mount can be adapted to most spindles with the help of an arbor.
- Thread mount are designed to adapt to tapping machines or fixed, threaded mount spindles.
- Includes: 2 rubber flex collets and 2 shanks.**



For Drill Presses, Drill Units & Manually Operated Machines With Rotating Spindles !

* Limited Supply

Capacity in Steel	Item#	Mount	Included Shanks	Price (E)
#0-1/4" (M1.4-M7)	3900-1250*	JT6	2 & 3 MT	377.12
	3900-1251	JT33	2&3 MT	392.70
#6-1/2" (M3-M12)	3900-1500	JT6	3 & 4 MT	501.88
	3900-1501	JT33	3 & 4 MT	527.22
#10-3/4" (M3-M20)	3900-1750	JT3	3 & 4 MT	551.09

TC TYPE MULTI-FUNCTION TAPPING HEADS

- Can be used on tapping, drilling, high speed machine and CNC with taper mounting.
- High precision and good stability.
- Adjustable clamping range.
- Quick and easy loading and unloading.
- Includes hook wrench and Allen wrench.

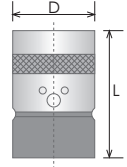

* Limited Supply

Item#	Taper Mount	Capacity	D (mm)	L (mm)	Price (F)
3900-1255*	JT6	1/8~1/2"	48	73	93.32
3900-1256	JT33	1/8~1/2"	48	73	93.32
3900-1259	JT3	1/8~5/8"	54	85	109.59

RUBBER FLEX TAP CHUCK COLLETS

- For tapping heads
- Multi range
- Accurate gripping force

Item#	Outside Diameter (Inch)	Capacity Range (Inch/mm)		Contact Length (Inch)	Cone Angle (Degree)	Price (E)
		Minimum	Maximum			
3900-1781	0.591	0.098/2.50	0.165/4.20	0.433	26	44.59
3900-1782	0.591	0.165/4.20	0.256/6.50	0.433	26	44.59
3900-1783	0.827	0.138/3.50	0.276/7.00	0.512	40	44.59
3900-1784	0.827	0.276/7.00	0.394/10.00	0.512	40	44.59
3900-1785	1.043	0.236/6.00	0.354/9.00	0.591	40	44.59
3900-1786	1.043	0.354/9.00	0.551/14.00	0.591	40	44.59



MINI E-Z HAND TAPPER

- Assures straight perpendicular tapped holes up to #10 diameter.



3900-0252
\$10828
 (F)

SPECIFICATIONS

Table size.....8-1/2x6"
 Height.....9"
 Clearance height.....3-3/4"
 Depth of throat.....4-1/2"
 Approx. weight.....12 lbs.

Complete with tap guide, precision ground work table, tap spindle wrench, and 7 steel tap adapters (#0-5/16")

7PC REPLACEMENT ADAPTER SET
 Range #0-5/16"
3900-0253
\$2205
 (F)



PRECISION HAND TAPPER

- Precision ground work table and spindle to high accuracy.
- 9 tap adapters included: #6, #8, #10, 1/4, 5/16, 3/8, 7/16, 1/2 & 5/8" .**
- Assures straight perpendicular tapped holes.
- Rigid structure made of high grade tool steel.
- Equipped with tap guide.
- Working Area: 6-1/2" x 10"
- Clearance Height: 7"
- Depth of Throat: 7-1/2"
- Overall Height: 13"
- Weight: 37 lbs.



3900-0250
\$25723
 (F)

9PC REPLACEMENT ADAPTER SET
 Range #6-5/8"
3900-0289
\$8645
 (E)



ULTRA PRECISION HAND TAPPER WITH TORQUE DRIVE HEAD

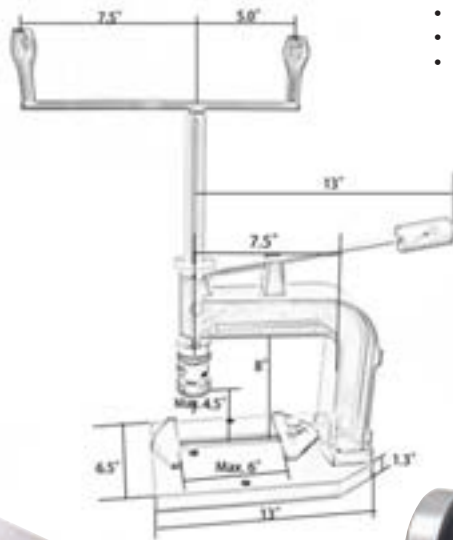
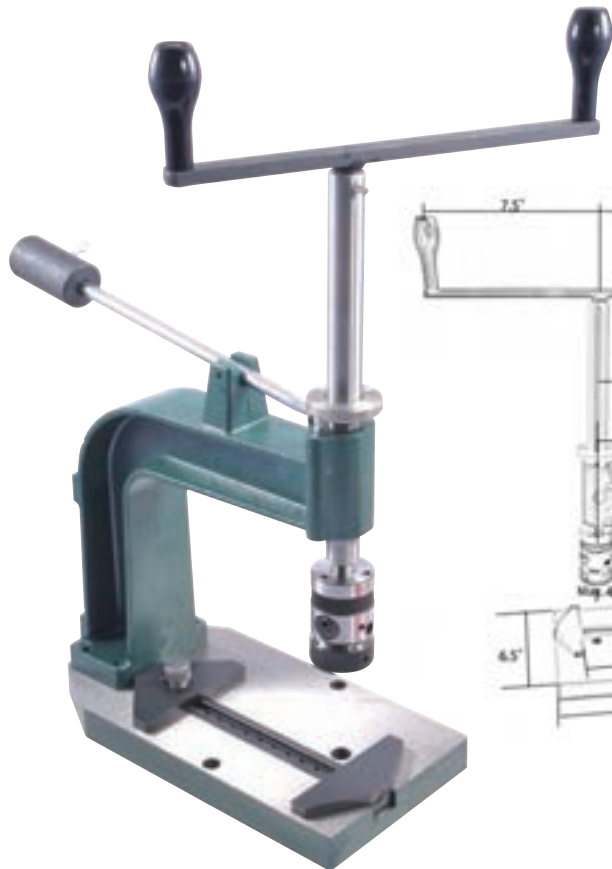

TAPPING RANGE: 1/8~1/2"/M2~M13

- Precision ground work table and spindle for high accuracy.
- Assures straight perpendicular tapped holes.
- Rigid structure.
- High torque tapping head with improved stability
- Adjustable clamping range.
- Tapping Range: 1/8~1/2"/M2~M13
- Includes hook wrench and Allen wrench.
- Weight: 40 lbs.

3900-0257
\$27720
(F)



D=48mm
L=73mm

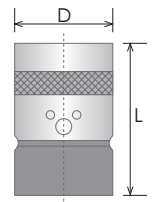

Tap Not Included

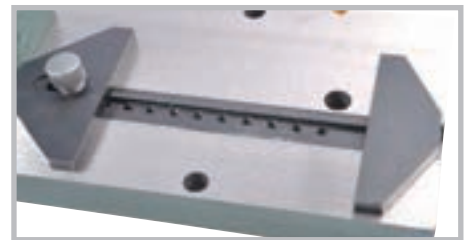
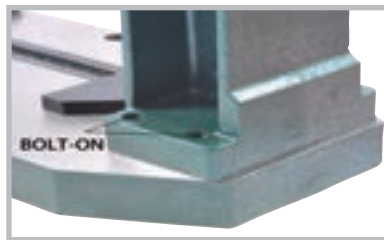

ULTRA PRECISION TORQUE DRIVE TAPPING HEAD RETROFIT KIT FOR CONVENTIONAL HAND TAPPER

UPGRADE YOUR TAPPING, ACCURACY AND STABILITY



- This precision rigidity is designed to improve the rigidity of a conventional hand tapper spindle with tapping adapters
- It works for the same type hand tapper with 25mm diameter spindle.
- High torque tapping head with improved stability
- Adjustable clamping range.
- Tapping Range: 1/8~1/2"/M2~M13
- Kit Includes: Handle, Spindle, Tapping Head, Hook Wrench and Allen Wrench.



3903-0257
\$12197
(F)

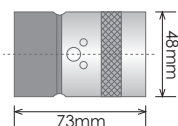

THREAD REPAIR TOOLS

HELICAL S.T.I. THREAD REPAIR KITS - SAE & METRIC

- Simple and easy to use kit.
- For repairing tapped holes.
- Cost effective system creates stronger than original threads.
- Creates a stronger internal thread in soft metals.
- Professional kit includes drills, STI taps and lug breaking tool.

- **132pc set Includes:**
- 110pc- Stainless Steel Inserts
- 5pc- STI HSS Taps
- 5pc- HSS Twist Drills
- 5pc- Coil Drivers
- 5pc- Tang Removers
- 1pc- L Hex Wrench
- 1pc- Metal Case



132PC SETS

Item#	Description	Insert Thread	STI Tap	HSS Drill	Price (F)
1011-0055	Coarse Thread Repair Kit	25ea-1/4-20	1/4-20	17/64	121.70
		25ea-5/16-18	5/16-18	21/64	
		25ea- 3/8-16	3/8-16	25/64	
		25ea-7/16-14	7/16-14	29/64	
		10ea-1/2-13	1/2-13	17/32	
1011-0056	Fine Thread Repair Kit	25ea-1/4-28	1/4-28	17/64	139.28
		25ea-5/16-24	5/16-24	21/64	
		25ea-3/8-24	3/8-24	25/64	
		25ea-7/16-20	7/16-20	29/64	
		10ea-1/2-20	1/2-20	17/32	
1011-0051	5-12mm	25ea-M5 x 0.80	M5 x 0.80	5.2	113.03
		25ea-M6 x 1.00	M6 x 1.00	6.3	
		25ea-M8 x 1.25	M8 x 1.25	8.3	
		25ea-M10 x 1.50	M10 x 1.50	10.4	
		10ea-M12 x 1.75	M12 x 1.75	12.4	

STAINLESS STEEL INSERTS LENGTH -1.5 X Diameter



- **16pc & 31pc Kit Includes:**
- 10pc or 25pc- Stainless Steel Inserts
- 1pc- STI HSS Tap
- 1pc- HSS Twist Drills
- 1pc- Coil Driver
- 1pc- Tang Breaker
- 1pc- L Hex Wrench
- 1pc- Metal Case

16PC & 31PC KITS

Item#	Insert-Thread	No of Insert In Set	STI Tap	HSS Drill	Price (F)
1011-0081	1/4-20	25	1/4-20	17/64	19.18
1011-0084	5/16-18	25	5/16-18	21/64	20.69
1011-0087	3/8-16	25	3/8-16	25/64	28.64
1011-0094	1/2-13	10	1/2-13	17/32	33.80
1011-0065	M5 x 0.80	25	M5 x 0.80	5.2	15.99
1011-0066	M6 x 1.00	25	M6 x 1.00	6.3	18.72
1011-0068	M8 x 1.25	25	M8 x 1.25	8.3	21.97
1011-0070	M10 x 1.50	25	M10 x 1.50	10.4	25.54
1011-0072	M12 x 1.75	10	M12 x 1.75	12.4	35.71

CUTTING & CARBIDE TOOLS

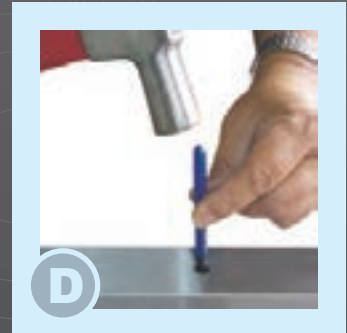
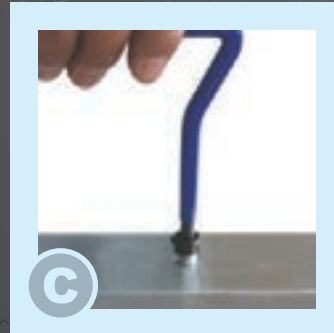
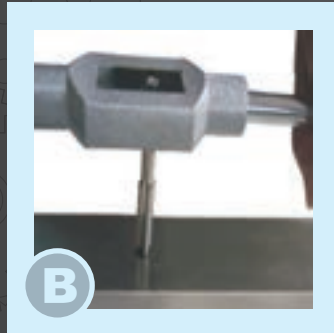
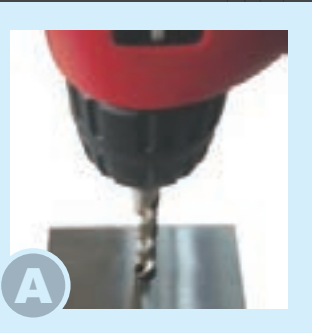

HELICAL THREAD REPAIR INSERTS - Stainless Steel - SAE & METRIC

- Thread repair inserts are used to fix a stripped bolt or screw thread or to install a strong, permanent threaded hole in metals, composites, wood or other materials. Helical inserts have a wired coil design. When inserted into a tapped hole with an installation tool, the coil expands to anchor the insert in place.
- Made of stainless steel
- Insert Length=1.5D(Diameter)



25PC/PACK Shown

APPLICATION: Renews worn threads.

Item#	Insert-Thread	PCS/Pack	Price (F)
1011-0240	M5 x 0.80	25	2.88
1011-0242	M6 x 1.00	25	3.32
1011-0244	M8 x 1.25	25	4.25
1011-0246	M10 x 1.50	25	5.24
1011-0248	M12 x 1.75	10	2.73
1011-0251	1/4-20	25	4.43
1011-0252	1/4-28	25	4.43
1011-0253	5/16-18	25	4.59
1011-0254	5/16-24	25	4.59
1011-0255	3/8-16	25	6.17
1011-0256	3/8-24	25	6.17
1011-0257	7/16-14	25	7.66
1011-0258	7/16-20	25	7.66
1011-0259	1/2-13	10	3.47
1011-0260	1/2-20	10	3.47

THREADING WIRE INSERT INSTALLATION TOOLS-SAE & METRIC

FOR HELICAL INSERTS

- These special tools make installing Threading Wire Inserts fast and easy.
- For use with wire thread inserts.

APPLICATION: Installation of Free Running & Screw Locking Helical Inserts.

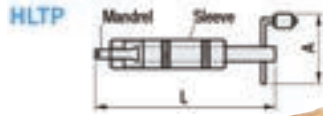

Item#	Insert-Thread	A	L	Price (F)
1011-0211	1/4-20	3	5-1/2	21.30
1011-0212	1/4-28	2-3/4	5-1/4	21.30
1011-0216	5/16-18	3	6-1/4	21.30
1011-0217	5/16-24	3	6-1/4	21.30
1011-0221	3/8-16	2-3/4	6-1/4	22.69
1011-0222	3/8-24	3	6-1/2	22.69
1011-0226	7/16-14	3-1/2	6-1/2	24.83
1011-0227	7/16-20	2-3/4	6-1/2	24.83
1011-0231	1/2-13	3-1/4	6-1/2	31.96
1011-0232	1/2-20	3-1/4	7	31.96
1011-0261	M5 x 0.80	3	5	19.90
1011-0266	M6 x 1.00	3	5.1/2	19.90
1011-0271	M8 x 1.25	3	6-1/4	21.30
1011-0276	M10 x 1.50	3	6-1/2	22.69
1011-0281	M12 x 1.75	2-3/4	6-1/2	24.83

SELF TAPPING THREAD REPAIR KITS-METRIC

- Self tapping, no pre-tapping required.
- Very high pull-out resistance.
- Unlimited thread re-usability.
- Protects expensive components from damage.
- Fits almost every application.
- Produces high quality, permanent, wear-resistant threads.
- Highly resistant to vibration, can withstand vibration without loosening.



Kit Includes:

- 10pc- Stainless Steel Inserts
- 1pc- Installation Tool
- 1pc- HSS Twist Drills
- 1pc- Metal Case

Item#	Insert-Thread	Price (F)
1011-0205	M5 x 0.80	21.80
1011-0207	M6 x 1.00	27.19
1011-0209	M8 x 1.25	34.43
1011-0210	M10 x 1.5	44.43
1011-0213	M12 x 1.75	53.87

18PC HSS TAP & DRILL COMBO SETS

- High speed steel made taps and drills.
- Steel case.
- Drills are matched with taps to make jobs much easier.



National Course Pitch Set Includes

- 1 each HSS Hand Tap
- 6-32 NC, 8-32 NC, 10-24 NC, 10-32 NF, 1/4"-20 NC, 5/16"-18 NC, 3/8"-16 NC, 7/16"-14 NC, 1/2"-13 NC
- 1 each HSS Jobbers Drill
- #36, #29, #25, #21, #7, F, 5/16" .U, 27/64"

National Fine Pitch Set
1011-0019
\$65⁹⁶
(E)

National Course Pitch Set
1011-0018
\$72²²
(E)

National Fine Pitch Set Includes

- 1 each HSS Hand Tap
- 6-40 NF, 8-36 NF, 10-24 NF, 10-32 NF, 1/4"-28 NF, 5/16"-24 NF, 3/8"-24 NF, 7/16"-20 NF, 1/2"-20 NF
- 1 each HSS Jobbers Drill
- #33, #29, #25, #21, #3, I, Q, 25/34", 29/64"

18PC HSS METRIC TAP & DRILL COMBO SET

- High speed steel made taps and drills.
- Plug taps are fully ground.
- With index steel case.
- Drills are matched with taps to make jobs much easier.

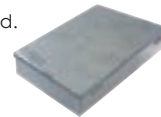

M2.5 ~ M12
1011-0020
\$65⁷⁵
(E)



Set Includes

- 1 each HSS Hand Tap
- M2.5x0.45, M3.0x0.50, M3.5x0.60, M4.0x0.70, M5.0x0.80, M6.0x1.00, M8.0x1.25, M10.0x1.50 & M12.0x1.75
- 1 each HSS Jobbers Drill
- 2.05, 2.50, 2.90, 3.30, 4.20, 5.00, 6.70, 8.50 & 10.20mm

14 PC H.S.S. 3-IN-1 COMBINED DRILL/TAP/COUNTERSINK & SCREWDRIVER BIT SETS

- Complete hole drilling, tapping, deburring and countersinking in one operation with power drill saves labor and time.
- For use to tap steel, copper, brass, aluminum and plastic up to 10-gauge (metal).
- Back tapered design helps prevent thread damage from over-drilling.
- One-piece drill/tap assures proper drill for tap size.
- Made of high speed steel for longer life.
- 14pc Includes: 6pc of combination drill & tap countersink.
1pc of high torque tested quick-change adapter
6pc of quick change CRV steel bit.
1pc of carry case.



1011-0141 Shown



INCH SET
#6~1/4"
1011-0140
\$32⁹⁹
(F)



1011-0140 Shown

Item#	Thread Range	CRV Bit	Price (F)
1011-0140	6~32, 8~32, 10~24 10~32, 12~24, 1/4~20	Slot3, Slot4, PZ1 PZ2, PH1, PH2	32.99
1011-0141	M3X0.5, M4x0.7, M5x0.8, M6x1.0, M8x1.25 & M10x1.5	Slot3, Slot4, PZ1 PZ2, PH1, PH2	35.49

DEBURRING TOOLS

DEBURRING TOOL SETS

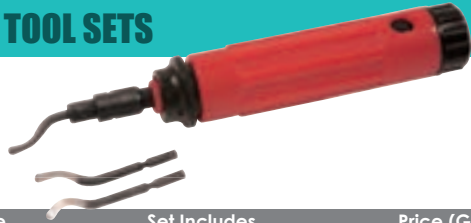

Item#	Style	Set Includes	Price (G)
2001-0220	B	4pc set -plastic handle, telescoping holder and blades B10 & B20	7.83
2001-0222	E	5pc set -plastic handle, telescoping holder and blades E100, E200 & E300	8.71

UNIVERSAL DEBURRING SET

SET INCLUDES:
 4 - Handles
 4 - Blades:
 B10 (for Aluminum)
 B20 (for Brass & Cast iron)
 E100 (for Steel)
 E102 (for Plastic)

8 PC SET
2001-0223
\$14.43
 (F)



ROYAL STYLE DEBURRING TOOL SET

- Pressing locking button to change blades.
- Blades can be stored in the handle.
- Accepts all "E" blades on the market.

SET INCLUDES:
 HANDLE BLADES:
 E100, E101, E102,
 E200 & E350



6 PC SET
2001-0226
\$9.36
 (F)

5PC BLADES
 (One each of E100,E101,E102,E200 & E350).....Item **2001-2261**.....\$6.94(F)

MINI DEBURRING & SCRAPING TOOL KIT

- Easy to reach the most inaccessible areas.
- Finishes workpiece perfectly.
- In fitted case

KIT INCLUDES:
 Flat diamond coated file,
 triangular scraper,
 round scraper,
 swivel blade tool,
 rotating deburring tool,
 flat scraper.



6 PC SET
2001-0228
\$32.48
 (E)

EDGE OFF STYLE DEBURRING TOOL

- Hexagonal aluminum handle with pocket clip.
- E100 blade mounted (not replaceable).

2001-0232
\$4.98
 (F)



RAPID PUSH BUTTON DEBURRING TOOL

- Push button to change blade.
- Accepts E100 blade (included).

2001-0233
\$8.78
 (F)

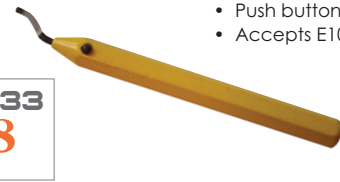

DEBURRING BLADES

SOLD IN PACKAGE QUANTITY !
Price Per Package of 10

10 PC PER PACKAGE

Blade Style	Item#	Price (F)	Description	Used with Set	Blade	APPLICATIONS						MATERIALS						
						Straight Edge	Hole Edge	Cross-Hole Both-Edges	Hole Black-Edge	Hole Inner Surface	Flat Surface	Sheet	Steel	Aluminum	Copper	Brass	Cast Iron	Stainless Steel
B10	2001-2201	7.85 Per Pack	HSS. Deburs materials with spiral chips	B		X	X						X	X	X			X
B20	2001-2202	8.16 Per Pack	HSS. Rotates clockwise & counterclockwise	B		X	X									X	X	X
B30	2001-2203	9.86 Per Pack	Simultaneously deburs the inside and outside of holes up to 0.16" (4mm) thick	B				X					X	X	X			X
E100	2001-2251	14.30 Per Pack	Heavy-duty HSS. Deburs material with spiral chips	E									X	X	X			X
E200	2001-2252	13.75 Per Pack	HSS for materials with powdery chips. Rotates clockwise & counterclockwise	E		X	X									X	X	X
E300	2001-2253	13.32 Per Pack	HSS for materials with spiral chips. Simultaneously deburs the inside and outside of holes up to 0.24" (6mm) thick	E				X					X	X	X			X
E350	2001-2258	12.70 Per Pack	HSS for materials with powdery chips. Rotates clockwise & counterclockwise	E		X	X									X	X	X

SCRAPER SET

- Triangular blades with 3 cutting edges and a telescopic blade holder that lets you reach hard to access areas.
- Provides maximum grip comfort when used with UNI handle.

SET INCLUDES:

UNI Handle with hex inner thread holder, Scraper D20, C25, D30, D40 & Wrench

Limited Supply!

6 PC SET
2001-0224
\$3228
(F)



10PC DIAMOND NEEDLE FILE SET MEDIUM-D126

- Can be used on carbide, hardened steel, glass and ceramics. Made with a hard chrome bond that gives a long life and wears extremely well.
- Overall length 5-1/2" .
- Diamond impregnated length: 1-9/16" .
- In fitted pouch.

INCLUDES SHAPES:

2 of round,
2 of hand,
1 of square,
Three - square,
half round,
barrette, flat, knife.

3000-0062
\$2266
(F)



6PC COUNTERSINK SET

- For chamfering and countersinking.
- Complete with fitted case.

INCLUDES:

UNI handle
M7 holder
Countersink: C12, C20 & C30
Wrench

Limited Supply!



2001-0234
\$7021
(F)

10PC DIAMOND RIFFLER FILE SET MEDIUM-D126

- Can be used for cleaning odd and difficult places.
- Diamond impregnated length: 1-9/16" .
- Overall length 5-1/2" .
- With fitted pouch.

3000-0072
\$3382
(F)

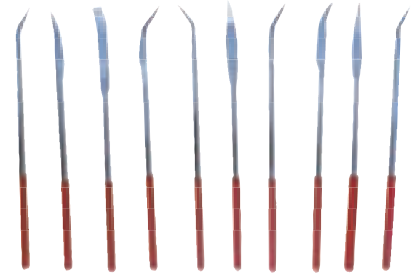

20PC DIAMOND PIN SET

- Various shapes and grit sizes for grinding carbide, ceramics, etc.
- Overall length 1-3/4" .
- Suitable for grinding in tight or precision areas, on jigs, dies and fixtures.

Limited Supply!

1/8" SHANK
3000-0049
\$662
(F)



TRIANGULAR HOLLOW SCRAPER

NEW

- An extremely useful accessory for scraping, trimming and deburring metals, tubing and other materials.
- Hollow ground cutting edge stays sharper longer and resharpenes easily.



2001-0210
\$695
(F)

12PC NEEDLE FILE SETS

- Industrial grade.
- Complete with durable pouch.
- Shapes: Barrette, Crossing, Equalling, Half Round, Round Edge Joint, Knife, Marking, Round, Slitting, Square, Three Square and Warding

5-1/2" OAL

#0 Cut
3000-0080
\$762
(F)



5PC STEEL FILE SET

- Shapes: Flat File, Round File, Square File, Three Square File & Half Round File
- For general purpose.
- Complete with durable handles.

3000-0055
\$1555
(F)



Overall Length: 12"

THREAD RESTORING FILES

- Restores Damaged or Rusted External Threads on Bolts, Threaded Shafts, Pipe and Pipe Fittings.
- Profile Shape: Square
- File Length: 8-1/2"
- Sizes clearly marked.

SAE Thread
1011-0040
\$1287
(F)

For Pitches: 12, 13, 14, 16, 18,
20, 24 & 28 Per Inch

METRIC Thread
1011-0044
\$1287
(F)

For Pitches: 0.75, 1.00, 1.25,
1.50, 1.75, 2.00, 2.50 & 3.00mm



BURRS & SCREW EXTRACTORS

CARBIDE ROTARY BURRS

- All rotary burs have hardened steel shanks.



SA Carbide Cylindrical Shape

Industrial No.	Cut Dia (In)	Cut Length (In)	Shank Dia. (In)	Item#	Price (F)
SA-1	1/4	5/8	1/4	3000-0101*	10.26
SA-3	3/8	3/4	1/4	3000-0103	15.18
SA-5	1/2	1	1/4	3000-0105	20.88
SA-6	5/8	1	1/4	3000-0106	26.94
SA-7	3/4	1	1/4	3000-0107	41.73



SC Carbide Cylindrical Ball Nose Shape

Industrial No.	Cut Dia (In)	Cut Length (In)	Shank Dia. (In)	Item#	Price (F)
SC-1	1/4	5/8	1/4	3000-0111	11.37
SC-3	3/8	3/4	1/4	3000-0113	15.18
SC-5	1/2	1	1/4	3000-0115	20.88
SC-6	5/8	1	1/4	3000-0116*	27.30
SC-7	3/4	1	1/4	3000-0117*	55.32



SD Carbide Ball Shape

Industrial No.	Cut Dia (In)	Cut Length (In)	Shank Dia. (In)	Item#	Price (F)
SD-1	1/4	1/4	1/4	3000-0121	11.58
SD-3	3/8	3/8	1/4	3000-0123	13.86
SD-5	1/2	1/2	1/4	3000-0125	18.60
SD-6	5/8	5/8	1/4	3000-0126	25.62
SD-7	3/4	3/4	1/4	3000-0127	31.11



SE Carbide Egg Shape

Industrial No.	Cut Dia (In)	Cut Length (In)	Shank Dia. (In)	Item#	Price (F)
SE-3	3/8	5/8	1/4	3000-0133*	15.00
SE-5	1/2	7/8	1/4	3000-0135*	20.88
SE-6	5/8	1	1/4	3000-0136*	28.08
SE-7	3/4	1	1/4	3000-0137*	42.48



SF Carbide Round Nose Tree Shape

Industrial No.	Cut Dia (In)	Cut Length (In)	Shank Dia. (In)	Item#	Price (F)
SF-1	1/4	5/8	1/4	3000-0141*	15.00
SF-5	1/2	1	1/4	3000-0145	22.77
SF-6	5/8	1	1/4	3000-0146	37.95
SF-7	3/4	1	1/4	3000-0147	42.12

*Limited Supply

INDIVIDUAL SCREW EXTRACTORS

- Quick & easy removal of broken screws, pipes, bolts, & studs without damaging the threads in the hole.



Item#	Size	For Remove Screw/Bolt	Drill to Use	Price (F)
1011-0021	#1	3/32~5/32"	5/64"	2.25
1011-0022	#2	5-32~7/32"	7/64"	2.46
1011-0023	#3	7/32~9/32"	5/32"	2.87
1011-0024	#4	9/32~3/8"	1/4"	3.46
1011-0025	#5	3/8~5/8"	17/64"	5.12

1/4" SHANK CARBIDE BURR SETS-Double Cut



5 PC SET
3000-0005
\$45.32 (E)

12 PC SET
3000-0012
\$95.45 (E)

SA-14, SA-1, SC-14, SC-1, SD-14, SD-1, SE-1, SF-1, SG-1, SM1, SM2 & SN-1

Overall Length: 2"



Type	Cutting Dia.	Cutting Length	Shape
SA-1	1/4	5/8	Cylindrical
SA-3	3/8	3/4	Cylindrical
SA-5	1/2	1	Cylindrical
SA-14	3/16	5/8	Cylindrical
SC-1	1/4	5/8	Cylindrical Radius End
SC-3	3/8	3/4	Cylindrical Radius End
SC-5	1/2	1	Cylindrical Radius End
SD-14	3/16	--	Ball
SD-1	1/4	--	Ball
SD-3	3/8	--	Ball
SE-1	1/4	3/8	Oval
SF-1	1/4	5/8	Oval
SF-3	3/8	3/4	Oval
SF-5	1/2	1	Oval
SG-1	1/4	5/8	Tree Point End
SG-3	3/8	3/4	Tree Point End
SM-1	1/4	1/2	Cone 22 Degree
SM-2	1/4	3/4	Cone 14 Degree
SN-1	1/4	5/16	Inverted Cone 10 Degree

SCREW EXTRACTOR & LEFT HAND DRILL SET

- Quick & easy removal of broken screws, pipes, bolts, & studs without damaging the threads in the hole.
- Supplied in plastic pouch.
- High speed steel



1011-0011
\$54.80 (E)

10 PC SET
Extractors: No. 1, 2, 3, 4 & 5
Left Hand Drill Bits: 1/8, 3/16, 1/4, 5/16 & 3/8"

8PC SCREW EXTRACTOR SETS

- Quick & easy removal of broken screws, pipes, bolts, & studs w/o damaging the threads in the hole.

Includes
#1, 2, 3, 4, 5, 6, 7 & 8 For Removing 3/32 ~ 1-3/8" of studs, bolts & screws

1011-0016
\$74.14 (F)



5PC SCREW EXTRACTOR SETS

- Quick & easy removal of broken screws, pipes, bolts, & studs w/o damaging the threads in the hole.
- Screw extractors made of chrome-molly steel.
- Supplied in plastic case.

Includes
#1, 2, 3, 4 & 5 For Removing 1/4-5/8" of studs, bolts & screws

1011-0015
\$23.13 (F)



6PC HSS END MILL SETS Center Cut • 3/8" Shank

- Single end.
- High speed steel.
- Center cut.
- With stand.

2 FLUTE SET
8000-0001
\$4158
(E)

6 PC INCLUDES:
1/8, 3/16, 1/4,
5/16, 3/8 & 1/2"

4 FLUTE SET
8000-0002
\$4190
(E)



TITANIUM COATED END MILL SETS

- Titanium coated for longer life.
- High speed steel, single end.
- Complete with wooden case.

20 PC SET
8000-0020
\$17727
(E)

2 & 4 FLUTE
10 PC OF EACH: 3/16-3/4" by 16ths

10 PC SET
5800-0010*
\$11490
(E)

4 FLUTE
3/16-3/4" by 16ths

*Limited Supply



**GROUND
FROM SOLID
CENTER CUT**



6PC COBALT 4 FLUTE END MILL SETS-SINGLE END

- Center cut.
- M42 (8%) cobalt, used for cut in tough high tensile strength materials like stainless steel, titanium and inconel.
- Uniform cutting load per tooth assures minimum chatter deflections.
- Preferred for light to medium removal rates and obtaining better surface finishes on soft, tough and long chip materials.
- With wooden stand.

M42 8% COBALT



8000-0004
\$12215
(E)

Set Includes

Size	Shank Dia.	Flute Length	OAL
1/8	3/8	1/2	2-11/32
3/16	3/8	9/16	2-3/8
1/4	3/8	11/16	2-1/2
5/16	3/8	3/4	2-17/32
3/8	3/8	3/4	2-1/2
1/2	1/2	1-1/4	3-9/32

3/16" SHANK DOUBLE-END 10PC END MILL SET

2&4 FLUTE
8000-0025
\$8860
(E)

1pc each: 1/16, 3/32, 1/8, 5/32 & 3/16"

- High speed steel.
- Center-cut.
- Double end.
- Supplied with wooden stand.



CORNER ROUNDING END MILLS & SET

**HIGH SPEED STEEL
FORMED RADIUS
CUTTERS-RH CUT**



8 PC SET
5800-4195
\$21603
(F)

1/16, 3/32, 1/8, 5/32, 3/16, 1/4, 5/16, 3/8"

- Intended for use in milling rounded corners, etc.
- Form-relieved type; can be sharpened many times without changing the form

6PC COBALT 4 FLUTE END MILL SET-DOUBLE END

- Center cut.
- M42 (8%) cobalt, used for cut in tough high tensile strength materials like stainless steel, titanium and inconel.
- Uniform cutting load per tooth assures minimum chatter deflections.
- Preferred for light to medium removal rates and obtaining better surface finishes on soft, tough and long chip materials.
- With wooden stand.

Set Includes

Size	Shank Dia.	Flute Length	OAL
1/8	3/8	3/8	3-1/16
3/16	3/8	1/2	3-1/4
1/4	3/8	5/8	3-3/8
5/16	3/8	3/4	3-1/2
3/8	3/8	3/4	3-1/2
1/2	1/2	1	4-1/8

M42 8% COBALT

8000-0005
\$15065
(E)



Item#	Radius	Diameter (Inch)		OAL	Price (F)
		Mill	Shank		
5800-4020	1/16	7/16	3/8	2-1/2	12.12
5800-4030	3/32	1/2	3/8	2-1/2	13.08
5800-4040	1/8	5/8	1/2	3	16.30
5800-4050	5/32	3/4	1/2	3	20.70
5800-4060	3/16	7/8	1/2	3	24.62
5800-4080	1/4	1	1/2	3	30.45
5800-4090	5/16	1-1/8	1/2	3-1/4	36.82
5800-4110	3/8	1-1/4	1/2	3-1/2	48.33
5800-4115	7/16	1-3/8	1	4	63.76
5800-4160	1/2	1-1/2	3/4	3-7/8	68.56

DOUBLE-END END MILLS

DOUBLE-END MINIATURE 3/16" SHANK END MILLS

- Used for general-purpose machining of both ferrous and nonferrous materials.
- Popular for small slotting, engraving, pocketing and similar applications.
- The medium-high helix angle produces an ideal shearing cut for outstanding performance.
- 3/16" shank.

HIGH SPEED STEEL



Diameter Mill (In)	Flute (In) Length	OAL (In)	Item#	2-Flute Price (F)	Item#	4-Flute Price (F)
1/32	3/32	2-1/4	5830-0002	8.14	-----	
3/64	9/64	2-1/4	5830-0003*	6.23	-----	
1/16	3/16	2-1/4	5830-0004*	6.82	5831-0018	6.58
5/64	15/64	2-1/4	5830-0005*	5.98	5831-0020*	6.89
3/32	9/32	2-1/4	5830-0006	7.37	5831-0022	6.56
7/64	21/64	2-1/4	5830-0007*	5.98	5831-0024	7.22
1/8	3/8	2-1/4	5830-0008*	6.82	5831-0026	6.34
9/64	13/32	2-1/4	5830-0009*	5.98	5831-0028*	6.34
5/32	7/16	2-1/4	5830-0011	5.98	5831-0030*	6.64
11/64	1/2	2-1/4	5830-0010*	5.98	5831-0031*	5.98
3/16	1/2	2-1/4	5830-0012	7.63	5831-0034	5.98

* Limited Supply

2-FLUTE DOUBLE-END END MILLS

GROUND FROM SOLID • CENTER CUTTING

- 2-Flute used for slotting, ramping, pocketing and plunging operations. Preferred for small and medium removal rates on soft, tough and long chip materials such as aluminum, copper & brass.

Limited Supply!



Diameter Mill (In)	Shank (In)	Flute (In) Length	OAL (In)	HSS Item#	Price (F)	TIN Coated Item#	Price (F)	M42 Cobalt Item#	Price (F)
1/8	3/8	3/8	3-1/16	5803-0125	6.56	-----		5825-0125	17.60
5/32	3/8	7/16	3-1/8	5803-0156	6.90	-----		-----	
3/16	3/8	7/16	3-1/8	5803-0187	6.99	5827-0187	10.45	5825-0187	16.59
1/4	3/8	1/2	3-1/8	5803-0250	8.18	-----		5825-0250	16.59
5/16	3/8	9/16	3-1/8	5803-0312	7.64	-----		5825-0312	16.59
3/8	3/8	9/16	3-1/8	5803-0375	8.27	5827-0375	11.00	5825-0375	16.59
1/2	1/2	13/16	4	5803-0500	12.83	5827-0500	17.20	5825-0500	33.03
9/16	5/8	1-1/8	4-1/2	5803-0562	17.69				
5/8	5/8	1-1/8	4-1/2	5803-0625	16.17				
3/4	3/4	1-5/8	5	5803-0750	19.34				
1	1	1-5/8	5-7/8	5803-1000	35.84				

HSS 4-FLUTE DOUBLE-END END MILLS

GROUND FROM SOLID • CENTER CUTTING



Diameter Mill (In)	Shank (In)	Flute (In) Length	OAL (In)	HSS Item#	Price (F)	TIN Coated Item#	Price (F)	M42 Cobalt Item#	Price (F)
1/8	3/8	3/8	3-1/16	5804-0125	10.50	5829-0125	14.87	5836-0125*	17.84
3/16	3/8	1/2	3-1/4	5804-0187	10.85	5829-0187	13.39	5836-0187*	19.65
1/4	3/8	5/8	3-3/8	5804-0250	10.85	5829-0250	15.55	-----	
5/16	3/8	3/4	3-1/2	5804-0312	9.28	5829-0312	16.59	5836-0312	19.93
3/8	3/8	3/4	3-1/2	5804-0375	11.50	5829-0375	15.39	-----	
1/2	1/2	1	4-1/8	5804-0500	19.08	5829-0500	23.17	-----	
5/8	5/8	1-3/8	5	5804-0625	21.66	5829-0625*	27.54	-----	
3/4	3/4	1-5/8	5-5/8	5804-0750	33.02	-----		5836-0750*	58.10

* Limited Supply

2-FLUTE SINGLE-END CENTER CUT END MILLS

GROUND FROM SOLID • CENTER CUTTING

- 2-Flute used for slotting, ramping, pocketing and plunging operations. Preferred for small and medium removal rates on soft, tough and long chip materials such as aluminum, copper & brass.



* Limited Supply

Diameter (In) Mill	(In) Shank	Flute (In) Length	OAL (In)	HSS		TiN Coated		M42 (8%)	
				Item#	Price (F)	Item#	Price (F)	Item#	Price (F)
1/8	3/8	3/8	2-5/16	5801-0125	6.01	5826-0125	10.06	5824-0125	14.12
3/16	3/8	7/16	2-5/16	5801-0187	6.05	5826-0187	8.92	5824-0187	14.12
1/4	3/8	1/2	2-5/16	5801-0250	6.30	5826-0250	9.95	5824-0250	15.34
5/16	3/8	9/16	2-5/16	5801-0312	6.30	5826-0312	7.31	5824-0312	17.49
3/8	3/8	9/16	2-5/16	5801-0375	6.08	5826-0375	8.94	5824-0375	17.49
7/16	3/8	13/16	2-1/2	5801-0437	8.12	-----	-----	5824-0437	16.98
1/2	3/8	1	3	5801-0500	10.92	-----	-----	5824-0500	18.63
1/2	1/2	1	3	5801-0501	9.11	5826-0501	13.29	-----	-----
9/16	1/2	1-1/8	3-1/8	5801-0562	11.75	-----	-----	5824-0562	23.83
5/8	1/2	1-1/8	3-1/8	5801-0625	15.50	-----	-----	5824-0625	27.17
5/8	5/8	1-5/16	3-7/16	5801-0626	13.08	5826-0626	18.12	5824-0626	25.08
3/4	1/2	1-5/16	3-5/16	5801-0750	22.24	-----	-----	5824-0751	44.88
3/4	3/4	1-5/16	3-9/16	5801-0753	17.96	-----	-----	-----	-----
7/8	3/4	1-1/2	3-5/8	-----	-----	-----	-----	5824-1001	50.49
1	1/2	1-1/2	3-5/8	5801-1000	22.83	-----	-----	5824-1002*	56.23
1	3/4	1-1/2	3-3/4	5801-1001	29.93	-----	-----	5824-1125*	56.23
1	1	1-5/8	4-1/8	5801-1002	20.11	-----	-----	5824-1250*	56.23
1-1/2	3/4	1-5/8	4-1/8	5801-1500*	40.74	-----	-----	-----	-----
2	3/4	1-5/8	4-1/8	5801-2000*	104.26	-----	-----	-----	-----

HSS 4-FLUTE SINGLE-END CENTER CUT END MILLS

GROUND FROM SOLID • CENTER CUTTING



Diameter (In) Mill	(In) Shank	Flute (In) Length	OAL (In)	HSS		TiN Coated		M42 Cobalt	
				Item#	Price (F)	Item#	Price (F)	Item#	Price (F)
1/8	3/8	3/8	2-5/16	5802-0125	6.11	5828-0125	8.33	5835-0125	15.73
3/16	3/8	1/2	2-3/8	5802-0187	6.64	5828-0187	7.44	5835-0187	15.73
1/4	3/8	5/8	2-1/2	5802-0250	6.71	5828-0250	8.61	5835-0250	15.73
5/16	3/8	3/4	2-1/2	5802-0312	6.79	5828-0312	8.61	5835-0312	16.33
3/8	3/8	3/4	2-1/2	5802-0375	8.85	5828-0375	9.85	5835-0375	18.80
7/16	3/8	13/16	2-1/2	5802-0437	8.32	5828-0437	13.60	5835-0437	18.53
1/2	3/8	13/16	2-1/2	5802-0500	13.25	5828-0500	13.18	5835-0500	24.65
1/2	1/2	1-1/4	3-1/4	5802-0501	12.22	5828-0501	14.61	5835-0501	25.09
9/16	1/2	1-3/8	3-3/8	5802-0562	16.54	5828-0562	20.23	5835-0562	27.38
5/8	1/2	1-5/16	3-7/16	5802-0625	16.15	-----	-----	5835-0625	39.86
5/8	5/8	1-5/8	3-3/4	5802-0626	16.87	5828-0626	19.66	5835-0626	34.37
3/4	1/2	1-5/8	3-5/8	5802-0750	21.55	-----	-----	5835-0750	48.08
3/4	5/8	1-5/8	3-3/4	5802-0751	24.94	-----	-----	-----	-----
3/4	3/4	1-5/8	3-7/8	5802-0753	22.36	5828-0751	26.23	5835-0753	48.36
7/8	3/4	1-7/8	4-1/8	-----	-----	-----	-----	5835-0875	57.88
1	1/2	1-7/8	4-1/8	5802-1000	41.57	-----	-----	5835-1000	75.27
1	3/4	1-7/8	4-1/8	5802-1001	38.09	-----	-----	5835-1001	82.50
1	1	2	4-1/2	5802-1002	47.46	-----	-----	5835-1002	89.70

6-FLUTE SINGLE-END CENTER CUT END MILLS



Limited Supply!

GROUND FROM SOLID • CENTER CUTTING

Diameter (In) Mill	(In) Shank	Flute (In) Length	OAL (In)	HSS		M42 Cobalt	
				Item#	Price (F)	Item#	Price (F)
1-1/4	1	2	4-1/2	-----	-----	5835-1250	93.30
1-1/4	1-1/4	2	4-1/2	5802-1256	33.48	-----	-----
1-1/2	1-1/4	2	4-1/2	5802-1506	62.44	-----	-----

SINGLE-END END MILLS & ROUGHERS

2 & 4 FLUTE SOLID CARBIDE SINGLE END MILLS

Cutting diameter tolerance + .0001/002



- Regular length
- Submicron grain carbide

CENTER CUTTING

APPLICATION

- **2 Flute** - For milling lower strength materials. Offers the maximum flute volume for chip removal
- **4 Flute** - For milling tougher metals where their thicker webs offer maximum rigidity and greater feed rates

• AITIN coating is beneficial in wet, semi-dry to dry cutting of most steels and highly abrasive materials. Provides good thermal stability for increased speeds and feeds that offers excellent heat resistance, good lubricity, better finishes and prolongs tool life.

* Limited Supply

Diameter (In) Mill	Shank	Flute (In) Length	OAL (In)	2-Flute				4-Flute			
				Uncoated Item#	Uncoated Price (E)	AITIN Coated Item#	AITIN Coated Price (E)	Uncoated Item#	Uncoated Price (E)	AITIN Coated Item#	AITIN Coated Price (E)
1/32	1/8	3/32	1-1/2	8003-0005*	11.52	5806-0313*	17.72	8003-1243*	22.65	5807-0313*	13.90
1/16	1/8	1/4	1-1/2	8003-0007	15.38	5806-0625*	16.66	8003-1245	11.76	-----	-----
3/32	1/8	3/8	1-1/2	8003-0009*	9.80	5806-0937*	15.40	-----	-----	5807-0937*	14.42
1/8	1/8	1/2	1-1/2	8003-0012	9.17	5806-1250	12.34	8003-1250	9.17	5807-1250	14.48
3/16	3/16	5/8	2	8003-0018	16.51	5806-1875	20.35	8003-1875	16.51	5807-1875	22.44
1/4	1/4	3/4	2-1/2	8003-0025	21.70	5806-2500	29.21	8003-2500	21.70	5807-2500	24.49
5/16	5/16	13/16	2-1/2	8003-0029*	24.90	-----	-----	8003-3125	29.88	5807-3125	33.18
3/8	3/8	1	2-1/2	8003-0037	36.58	5806-3750	47.21	8003-3750	36.58	5807-3750	41.24
1/2	1/2	1	3	8003-0050	78.29	5806-5000	69.98	8003-5000	56.02	5807-5000	90.01

M42 COBALT ROUGHING END MILLS-FINE PITCH

GROUND FROM SOLID M42 BLANK • 8% COBALT • CENTER CUTTING

- Recommended for high production milling in difficult-to-machine materials such as inconel, hasteloy, titanium alloys and other materials up to RC 40
- The pressure of the cut is distributed over many teeth.
- Low co-efficient friction.



* Limited Supply

Size (In)	Shank Dia.	Flute Length	OAL	Flute	Item#	Price (F)
3/16	3/8"	1/2	2-3/8	4	5823-0187	14.98
1/4	3/8	5/8	2-7/16	4	5823-0250	14.35
1/4	3/8	1-1/4	3-1/16	4	5823-0251	20.62
5/16	3/8	3/4	2-1/2	4	5823-0312	15.18
3/8	3/8	3/4	2-1/2"	4	5823-0375	15.86
3/8	3/8	1-1/2	3-1/4	4	5823-0376	20.64
7/16	3/8	1	2-11/16	4	5823-0437	18.72
1/2	1/2	1-1/4	3-1/4	4	5823-0500	30.29
1/2	1/2	2	4	4	5823-0501	29.81
1/2	1/2	3	5	4	5823-0502	37.75
9/16	1/2	1-3/8	3-3/8	4	5823-0562	28.47
5/8	5/8	2-1/2	4-5/8	4	5823-0626	38.09

Size (In)	Shank Dia.	Flute Length	OAL	Flute	Item#	Price (F)
3/4	3/4	3/4	2-7/8	4	5823-0750	46.92
3/4	3/4	3	5-1/4	4	5823-0752	63.26
7/8	3/4	1-7/8	4-1/8	5	5823-0875	61.83
1	1	2	4-1/2	5	5823-1000	65.66
1	1	4	6-1/2	5	5823-1002	125.85
1-1/4	1-1/4	2	4-1/2	6	5823-1250	92.96
1-1/2	1-1/4	2	4-1/2	6	5823-1500	120.64
1-1/2	1-1/4	3	5-1/2	6	5823-1501*	187.55
2	1-1/4	2	4-1/2	8	5823-2000	318.60
2	1-1/4	4	6-1/2	8	5823-2001*	206.61
2	2	2	5-3/4	8	5823-2002*	149.03
2	2	4	7-3/4	8	5823-2003*	257.62

M42 COBALT ROUGHING END MILLS

- Their uniform cutting load per tooth assures minimum chatter deflection.
- Fast stock removal.
- Ideal for N/C machines.

• GROUND FROM SOLID M42 BLANK
• 8% COBALT
• CENTER CUTTING



Size (In)	Shank Dia.	Flute Length	OAL	Flute	Uncoated		Tin Coated	
					Item#	Price(F)	Item#	Price(F)
1/4	3/8	5/8	2-7/16	3	8002-5708	16.12	8002-6708	17.55
1/4	3/8	5/8	2-7/16	4	8002-5710	16.82	-----	-----
5/16	3/8	3/4	2-1/2	4	8002-5716	16.64	-----	-----
3/8	3/8	3/4	2-1/2	4	8002-5721	17.00	8002-6721	17.86
3/8	3/8	1-1/2	3-1/4	4	8002-5727	20.46	-----	-----
1/2	1/2	1-1/4	3-1/4	4	8002-5733	23.79	8002-6733	26.91
1/2	1/2	2	4	4	8002-5736	27.38	-----	-----
5/8	5/8	1-5/8	3-3/4	4	8002-5748	33.49	8002-6748	30.24
3/4	3/4	1-5/8	3-3/4	4	8002-5766	47.27	-----	-----
3/4	3/4	1-5/8	3-7/8	4	8002-5770	46.10	8002-6770	47.50
3/4	3/4	3	5-1/4	4	8002-5775	55.77	-----	-----
1	3/4	1-1/2	3-3/8	5	8002-5794	63.23	-----	-----
1	1	2	4-1/2	5	8002-5802	71.94	8002-6802	85.15
1	1	3	5-1/2	5	8002-5805	81.82	-----	-----

BALL NOSE END MILLS & MILLING CUTTERS

HSS BALL NOSE END MILL SETS

- Single end.
- Full radius cutting edge.
- Designed for milling radius bottom slots, fillets and special contours.
- Wooden stand included.



8001-0009 Shown

DIMENSIONS	
(Mill x Shank x Flute Length x OAL)	
1/8	3/8 x 3/8 x 2-5/16"
3/16	3/8 x 1/2 x 2-3/8"
1/4	3/8 x 5/8 x 2-7/16"
5/16	3/8 x 3/4 x 2-1/2"
3/8	3/8 x 3/4 x 2-1/2"
7/16	1/2 x 1 x 3"
1/2	1/2 x 1 x 3"
5/8	1/2 x 1-1/8 x 3-1/8"
3/4	1/2 x 1-5/8 x 3-5/8"



CENTER CUT • HIGH SPEED STEEL

Item#	Set	Flute	Size Includes	Price (F)
8001-0006	6PC	2	1/8, 3/16, 1/4, 5/16, 3/8 & 1/2"	66.40
8001-0007	6PC	4	1/8, 3/16, 1/4, 5/16, 3/8 & 1/2"	79.51
8001-0009	9PC	2	1/8, 3/16, 1/4, 5/16, 3/8, 7/16, 1/2, 5/8 & 3/4"	130.70

2-FLUTE HSS BALL NOSE END MILLS

- Used for general-purpose machining of both ferrous and nonferrous materials.

HIGH SPEED STEEL



Diameter (In) Mill	Shank	Flute (In) Length	OAL (In)	Item#	Price (F)
1/8	3/8	3/8	2-5/16	5841-0125	11.78
3/16	3/8	7/16	2-5/16	5841-0187	12.32
1/4	3/8	5/8	2-7/16	5841-0250	12.82
5/16	3/8	3/4	2-1/2	5841-0312	12.51
3/8	3/8	3/4	2-1/2	5841-0375	12.40
7/16	1/2	1	3	5841-0437*	14.45
1/2	1/2	1	3	5841-0500	21.03
9/16	1/2	1	3	5841-0562	28.10
5/8	5/8	1-3/8	3-3/8	5841-0625	24.80

*Limited Supply

2-FLUTE M42 COBALT BALL NOSE END MILLS

- M42 Cobalt (8%) is designed to cut difficult and abrasive materials, ranging from medium to high hardness. Roughing end mills are made of cobalt to withstand elevated temperatures and assure high-edge hardness during rapid stock removal. Choose cobalt end mills on hardwork materials or when there is a problem with wear or short tool life.

M42 (8%) COBALT



Diameter (In) Mill	Shank	Flute (In) Length	OAL (In)	M42 COBALT Item#	Price (F)
1/8	3/8	3/8	2-5/16	5842-0125	23.84
3/16	3/8	1/2	2-3/8	5842-0187	23.48
1/4	3/8	5/8	2-7/16	5842-0250	23.58
3/8	3/8	3/4	2-1/2	5842-0375	23.48
1/2	1/2	1	3	5842-0500	33.59
1	1	2-1/4	4-3/4	5842-1000*	80.59

*Limited Supply

CONVEX RADIUS HSS MILLING CUTTERS

- Precision ground
- Performance at lower cost
- Better finish possible in many materials with profile ground.
- Used for milling female half circle.

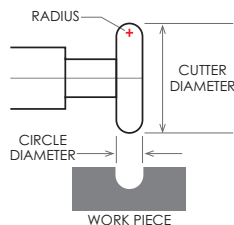

HIGH SPEED STEEL



Item#	No. of Teeth	Radius (Inch)	Cutter Dia(In)	Shank Dia(In)	OAL (Inch)	Price (F)
2006-0401	6	1/32	3/4	1/2	3	24.57
2006-0406	6	1/16	3/4	1/2	3	30.68
2006-0416	6	1/8	1-1/4	3/4	3-1/2	43.05

CONVEX MILLING CUTTERS

- Teeth are relieved and straight gashed.
- Cutting surfaces may be resharpened on face without changing contour.

HIGH SPEED STEEL

Use For Milling Female Half Circle

NEW



Item#	Circle Dia.	Cutter Dia.	Hole Size	Price (F)
2006-0421	1/8"	2-1/4"	1	39.51
2006-0424	3/16"	2-1/4"	1	46.66
2006-0427	1/4"	2-1/2"	1	54.11

CUTTERS & SETS

60° ANGLE DOVETAIL CUTTERS & SET

5PC SET INCLUDES:

- Cutter Diameters: 3/8, 1/2, 3/4, 1-3/8 & 1-7/8"
- Supplied with wooden stand

5 PC SET
2006-0205
\$179.80
(E)

Individual

HIGH SPEED STEEL • RIGHT HAND CUT • 60° ANGLE

Item#	Cutter Dia. (Inch)	Shank Dia. (Inch)	Face OAL (Inch)	Length of Cut (Inch)	Price (E)
2006-0210	3/8	3/8	2-1/8	3/16	21.56
2006-0212	1/2	3/8	2-1/8	1/4	21.56
2006-0214	3/4	3/8	2-1/8	5/16	25.40
2006-0216	1-3/8	5/8	2-7/8	9/16	43.76
2006-0218	1-7/8	7/8	3-1/4	13/16	72.60
2006-0220	2-1/4	1	3-3/4	1-1/16	99.00



SINGLE ANGLE 45° HSS CHAMFERING CUTTERS

- Use for chamfering and other angular milling operations.
- Made from high speed steel.



- HIGH SPEED STEEL
- RIGHT HAND CUT
- 45° CHAMFER ANGLE

Cutter Dia.	Cutter Width	Shank Dia.	Overall Length	Item#	Price (F)
1/2	1/8	3/8	2-1/8	2006-0381	26.36
3/4	3/16	3/8	2-1/8	2006-0383	39.03
1	5/16	1/2	2-1/2	2006-0385	62.43
1-1/2	1/2	3/4	2-3/4	2006-0387	115.67

SINGLE ANGLE 45° COBALT CHAMFERING CUTTERS

M42 (8%) COBALT • RIGHT HAND CUT • 45° CHAMFER ANGLE

- Use for chamfering and angle milling operations.



Cutter Dia.	Cutter Width	Shank Dia.	Overall Length	Item#	Price (F)
1/2	1/8	3/8	2-1/8	2006-0351	66.22
3/4	3/16	3/8	2-1/8	2006-0353	114.69
1	5/16	1/2	2-1/2	2006-0356	118.85
1-1/2	1/2	3/4	2-3/4	2006-0360	222.90

DOUBLE ANGLE COBALT SHANK CUTTERS

- Double angle cutters are available with either a 60° or 90° included angle for milling a double angle cut in one pass.

M42 (8%) COBALT

Cutter Angle A	Cutter Dia. D1	Shank Dia. D2	Cutter Width W	Overall Length L1	Item #	Price (F)
60°	3/4	3/8	3/16	2-3/8	2006-0301	78.47
	1	1/2	5/16	2-27/32	2006-0303	124.83
	1-1/2	5/8	1/2	3-3/8	2006-0306	138.91
	2-1/4	7/8	3/4	4-5/32	2006-0310	339.61
90°	3/4	3/8	1/4	2-7/16	2006-0331*	71.32
	1	1/2	3/8	2-29/32	2006-0333*	100.56
	1-1/2	5/8	9/16	3-7/16	2006-0336*	116.89
	2-1/4	7/8	3/4	4-5/32	2006-0340*	301.73

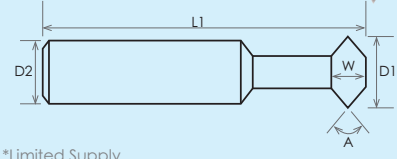

*Limited Supply

HSS T-SLOT CUTTERS

- High speed steel.
- Rugged design with free cutting features.
- Cutters have positive radial rake, right and left hand spiral with alternate side cutting teeth for maximum chip clearance.

HIGH SPEED STEEL



*Limited Supply

Bolt Size	Cutter Dia.	Cutter Width	Neck Dia.	Shank Dia.	Undercut Length	OAL	Tooth	Item#	Price (F)
1/4	9/16	15/64	17/64	1/2	35/64	2-19/32	8	2006-0161	27.05
5/16	21/32	17/64	21/64	1/2	39/64	2-11/16	8	2006-0163	31.95
3/8	25/32	21/64	13/32	3/4	3/4	3-1/4	8	2006-0165	40.07
1/2	31/32	25/64	17/32	3/4	3/4	3-7/16	8	2006-0167	44.81
5/8	1-1/4	31/64	21/32	1	1-9/64	3-15/16	10	2006-0169*	60.42
3/4	1-15/32	5/8	25/32	1	1-1/2	4-7/16	10	2006-0171*	76.83
1	1-27/32	53/64	1-1/32	1-1/4	1-43/64	4-13/16	10	2006-0173*	116.63
1-1/4	2-7/32	1-3/32	1-9/32	1-1/4	1-31/32	5-3/8	12	2006-0175*	150.34
1-1/2	2-21/32	1-11/32	1-17/32	1-1/4	2-1/8	5-29/32	12	2006-0177*	200.36

PLAIN METAL SLITTING SAWS

- For general-purpose slotting and cut-off operations. Sides concave for smooth cuts.
- With keyway (except 3").



HIGH SPEED STEEL

*Limited Supply

Dia. (Inch)	No. of Teeth	Face (Inch)	Hole (Inch)	Item #	Price (F)
3	30	1/64	1	5071-4201	8.74
3	30	1/32	1	5071-4202	9.08
3	30	3/64	1	5071-4203	9.42
3	30	1/16	1	5071-4204	10.38
3	30	3/32	1	5071-4206	13.39
3	30	1/8	1	5071-4208	14.28
3	30	5/32	1	5071-4210	14.75
4	36	1/32	1	5071-4402	22.11
4	36	1/16	1	5071-4404	21.62
4	36	3/32	1	5071-4406	23.28
4	36	1/8	1	5071-4408	27.19
4	36	5/32	1	5071-4410*	13.60
5	40	1/16	1	5071-4604	42.51
5	40	3/32	1	5071-4606*	23.41
5	40	1/16	1-1/4	5071-4704*	21.30
5	40	3/32	1-1/4	5071-4706*	26.40
5	40	1/8	1-1/4	5071-4708*	28.51
5	40	5/32	1-1/4	5071-4710*	29.37
5	40	3/16	1-1/4	5071-4712*	34.03
6	42	3/32	1	5071-4806*	31.06
6	42	1/8	1	5071-4808*	36.89
6	42	5/32	1	5071-4810*	39.14

5PC METAL SLITTING SAW KIT

- For general-purpose slotting and cut-off operations. Sides concave for smooth cuts.
- Mandrel: 1/8"



KIT INCLUDES

Dia. (Inch)	Thickness (Inch)	Hole (Inch)
7/8	0.016	1/4
1	0.020	1/4
1-1/4	0.024	1/4
1-1/2	0.028	1/4
1-3/4	0.031	1/4

5PC KIT
7/8-1-3/4"
5071-5000
\$5.78 (F)

HIGH SPEED STEEL

SLOTING SAW ARBORS

- For saw blades upto 3/16" thick



Item#	Shank	OAL	For Saw Hole Size	Price (F)
3900-0144	R8	5-3/32"	1/2, 5/8, 3/4, 7/8 & 1"	30.92
3900-0145	1/2"	2-9/16"	1/2, 5/8, 3/4, 7/8 & 1"	20.76

14.5° & 20° PRESSURE ANGLE INVOLUTE GEAR CUTTERS

NEW

- Involute gear cutters make it possible to machine gears on your mill -either CNC mills or manual mills. The gear cutter is made into the involute profile, which transfers its shape to your gear blank, allowing it to run with other gears. The gear cutter needs to be matched to your gear specifications: diametral pitch or module, pressure angle, and even the number of teeth it will cut.
- The profile of all involute spur gears changes slightly as the tooth count changes, and so the profile of the gear cutter changes as well. Cutters are numbered from #1-#8 depending on how many teeth it will cut.
- For spur gears with 14.5° & 20°.
- Made from high speed steel
- Ground from solid.
- Straight teeth on periphery of cutters.
- Bright finish.



2041-1012 Shown



2040-0825 Shown

HIGH SPEED STEEL

Cutter Number	Range of Teeth Cut
#1	135 to rack
#2	55-134
#3	35-54
#4	26-34
#5	21-25
#6	17-20
#7	14-16
#8	12-13

14.5° Pressure Angle

Pitch	Cutter Diameter	Arbor Hole	#1 Item#	Price (F)	#3 Item#	Price (F)	#4 Item#	Price (F)	#5 Item#	Price (F)	#6 Item#	Price (F)	#7 Item#	Price (F)	#8 Item#	Price (F)
10	2-3/4	1	2041-1012	41.93	2041-1038	41.93	-----	-----	-----	-----	2041-1061	40.53	-----	-----	-----	-----
12	2-5/8	1	2041-1210	41.93	-----	-----	-----	-----	-----	-----	-----	-----	2041-1277	41.93	2041-1285	41.93
16	2-1/2	1	-----	-----	-----	-----	-----	-----	-----	-----	-----	-----	-----	-----	2041-1688	23.53
20	2-3/8	1	-----	-----	-----	-----	-----	-----	2041-2051	32.76	-----	-----	-----	-----	-----	-----
48	1-3/4	7/8	-----	-----	-----	-----	2041-4842	29.72	-----	-----	-----	-----	2041-4875	29.72	2041-4883	29.72

20° Pressure Angle

Pitch	Cutter Diameter	Arbor Hole	#2 Item#	Price (F)	#3 Item#	Price (F)	#4 Item#	Price (F)	#7 Item#	Price (F)	#8 Item#	Price (F)
8	2-7/8	1	2040-0825	60.87	-----	-----	-----	-----	-----	-----	-----	-----
10	2-3/4	1	-----	-----	-----	2040-1047	41.93	-----	-----	-----	-----	-----
12	2-5/8	1	2040-1229	41.93	-----	2040-1045	41.93	2040-1278	41.93	2040-1286	41.93	-----
16	2-1/2	1	-----	-----	2040-1633	37.38	-----	2040-1674	37.38	2040-1682	37.38	-----
20	2-3/8	1	-----	-----	2040-2137	32.76	-----	-----	-----	-----	-----	-----

KEYWAY BROACHES & SETS

HSS KEYWAY BROACH SETS-HEAVY DUTY • HIGH SPEED STEEL

- Heavy duty.
- High speed steel.
- Provides great versatility.
- Specialty tools designed for cutting keyways in machined holes.
- Typically used manually with an arbor press or hydraulic press to produce the keyways.
- Well suited for use in a variety of ferrous and non-ferrous materials.
- Includes shims & wooden case.

30 PC SET
2006-0056
\$492⁰⁰
(E)
INCLUDES: 5 Broaches,
18 Collared Bushings, 7 Shims

17 PC SET
2006-0054
\$317⁸³
(E)
4 Broaches, 9 Collared Bushings, 4 Shims



2006-0054 Shown

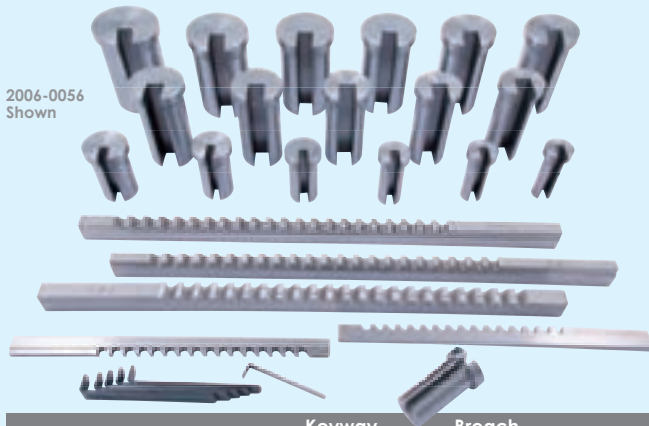

2006-0056 Shown



9 PC SET
2006-0051
\$166⁹²
(E)
INCLUDES: 3 Broaches,
5 Collared Bushings, 1 Shim

2006-0051 Shown

Item#	Set	Keyway Size	Broach Style	Collared Bushing	Keyway Combination
2006-0051	9PC	1/16, 3/32, 1/8"	A	1/4, 5/16", 3/8, 7/16", 1/2"	15
2006-0054	17PC	1/8, 3/16" 1/4, 3/8"	B C	1/2, 5/8, 3/4, 7/8", 1, 1-1/8, 1-1/4, 1-3/8, 1-1/2"	18
2006-0056	30PC	1/8, 3/16" 1/4, 5/16, 3/8"	B C	1/2, 9/16, 5/8, 11/16, 3/4, 13/16, 7/8, 15/16, 1, 1-1/16, 1-1/8, 1-3/16, 1-1/4, 1-5/16, 1-3/8, 1-7/16, 1-1/2, 1-9/16"	47

SHIMS - FOR KEYWAY BROACHES



A Style

C Style

Item#	Style-Size	Price (F)	Item#	Style-Size	Price (F)
2006-1552	A-1/8"	3.22	2006-1574	C-5/16"	3.22
2006-1556	B-1/8"	3.22	2006-1578	D-5/16"	5.45
2006-1558	B-5/32"	3.22	2006-1582	D-3/8 & 1/2"	5.45
2006-1562	B-3/16"	3.22	2006-1586	D-7/16"	5.45
2006-1566	C-3/16"	3.22	2006-1590	E-5/8 & 3/4"	5.45
2006-1570	C-1/4 & 3/8"	3.22	2006-1594	F-7/8 & 1"	5.45

KEYWAY BROACHES HEAVY DUTY • HIGH SPEED STEEL

- Broach is tapered and ground with bright finishing.
- Shim included.
- One-pass keyway broaches require appropriate guide bushing.

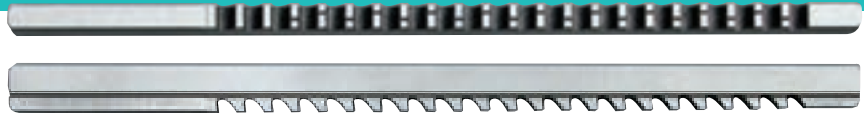

Item#	Broach Size	Type	Broach Dimensions	Shims Required	Length of Cut (Min.)	Length of Cut (Max)	Tolerances	Price (F)
2006-1008	1/8"	A	1/8 x 5	1	13/64	1-1/8	.1252-.1262	41.33
2006-1018	1/8"	B	3/16 x 6-3/4	1	19/64	1-11/16	.1252-.1262	45.05
2006-1022	3/16	B	3/16 x 6-3/4	1	19/64	1-11/16	.1877-.1887	45.05
2006-1024	3/16	C	3/8 x 11-3/4	1	25/64	2-1/2	.1877-.1887	63.56
2006-1026	1/4	C	3/8 x 11-3/4	1	25/64	2-1/2	.2502-.2512	59.56
2006-1030	5/16	C	3/8 x 11-3/4	2	25/64	2-1/2	.3127-.3137	59.56
2006-1034	3/8	C	3/8 x 11-3/4	2	25/64	2-1/2	.3755-.3765	59.56
2006-1046	1/2	D	9/16 x 13-7/8	3	1	6	.5006-.5016	113.90
2006-1050	5/8	E	3/4 x 15-1/2	4	1	6	.6260-.6270	184.44

KEYWAY BUSHINGS & SQUARE BROACHES

KEYWAY BUSHINGS

- Different size bushings enable the individual keyway broach to be used in a variety of sizes.



STYLE "A", 1/8" SLOT-COLLARED

Bushing	Diameter	Item#	Price (F)
A	1/4	2006-1102	8.52
A	5/16	2006-1104	8.52
A	3/8	2006-1106	9.65
A	7/16	2006-1108	8.65
A	1/2	2006-1110	8.52

STYLE "E", 3/4" SLOT-PLAIN TYPE

Bushing	Diameter	Item#	Price (F)
E	2-5/16	2006-1502	39.35
E	2-3/8	2006-1504	39.35
E	2-7/16	2006-1506	39.35
E	2-1/2	2006-1508	39.35
E	2-9/16	2006-1510	48.52
E	2-5/8	2006-1512	48.52
E	2-11/16	2006-1514	48.52
E	2-3/4	2006-1516	48.52
E	2-13/16	2006-1518	48.52
E	2-7/8	2006-1520	48.52
E	2-15/16	2006-1522	48.52
E	3	2006-1524	48.52

D,E STYLE: Plain
A,B,C STYLE: Collared

The letter designation signifies the body width of the keyway broach



STYLE "B", 3/16" SLOT-COLLARED

Bushing	Diameter	Item#	Price (F)
B	1/2	2006-1202	8.91
B	9/16	2006-1204	8.52
B	5/8	2006-1206	8.52
B	11/16	2006-1208	8.52
B	3/4	2006-1210	8.96
B	13/16	2006-1212	8.52
B	7/8	2006-1214	8.52

STYLE "C", 3/8" SLOT-COLLARED

Bushing	Diameter	Item#	Price (F)
C	3/4	2006-1302	12.97
C	13/16	2006-1304	12.97
C	7/8	2006-1306	12.97
C	15/16	2006-1308	12.97
C	1	2006-1310	12.97
C	1-1/16	2006-1312	12.97
C	1-1/8	2006-1314	14.60
C	1-3/16	2006-1316	14.60
C	1-1/4	2006-1318	14.60
C	1-5/16	2006-1320	14.70
C	1-3/8	2006-1322	14.70
C	1-7/16	2006-1324	14.60
C	1-1/2	2006-1326	14.60
C	1-9/16	2006-1328	14.70

STYLE "D", 9/16" PLAIN TYPE

Bushing	Diameter	Item#	Price (F)
D	1-7/16	2006-1402	17.04
D	1-1/2	2006-1404	17.04
D	1-9/16	2006-1406	17.04
D	1-5/8	2006-1408	17.85
D	1-11/16	2006-1410	23.61
D	1-3/4	2006-1412	23.61
D	1-13/16	2006-1414	23.61
D	1-7/8	2006-1416	23.61
D	2	2006-1420	23.61
D	2-1/16	2006-1422	26.90
D	2-1/8	2006-1424	26.90
D	2-3/16	2006-1426	26.90
D	2-1/4	2006-1428	34.08
D	2-5/16	2006-1430	34.08
D	2-3/8	2006-1432	34.08
D	2-7/16	2006-1434	34.08
D	2-1/2	2006-1436	47.19
D	2-9/16	2006-1438	47.19
D	2-5/8	2006-1440	47.19
D	2-11/16	2006-1442	47.19
D	2-3/4	2006-1444	47.19
D	2-13/16	2006-1446	47.19
D	2-7/8	2006-1448	47.19
D	2-15/16	2006-1450	47.19
D	3	2006-1452	47.19

SQUARE PUSH BROACHES HEAVY DUTY • HIGH SPEED STEEL

- Broach is tapered and ground with bright finishing.
- Used for cutting square shaped hole in round pilot holes.
- Well suited for ferrous and non-ferrous materials.



Item#	Broach Size	Broach Length	Pilot Dia.	(Inch) Drill Size		Length of Cut		Tolerance	Price (E)
				Min.	Max.	Min.	Max.		
2006-0114	1/4	6-1/2	17/64	17/64	1/4	3/4	.2505~.2515	120.54	
2006-0122	3/8	9-3/8	25/64	25/64	3/8	1-1/4	.3755~.3765	140.34	
2006-0124	7/16	10-7/8	29/64	9/64	1/2	1-3/8	.4385~.4395	163.87	
2006-0126	1/2	12	17/32	17/32	1/2	1-3/8	.5005~.5015	184.80	
2006-0138	3/4	17-3/4	13/16	13/16	5/8	1-5/8	.7510~.7520	374.69	

1/2" SHANK 10PC WOODRUFF KEYSEAT CUTTER SET

- Straight tooth.
- Designed for using together with normal end mills for milling standard woodruff keyseat, slots.

HIGH SPEED STEEL

10PC SET
2006-0452
\$189.25 (F)

Includes: 204,305,403,404,
406,505,606,608,806 & 808



Dimensions

American Standard	Cutter Diameter	Face Width	Overall Legth
204	1/2	1/16	2-1/16
305	5/8	3/32	2-3/32
403	3/8	1/8	2-1/8
404	1/2	1/8	2-1/8
406	3/4	1/8	2-1/8
505	5/8	5/32	2-5/32
606	3/4	3/16	2-3/16
608	1	3/16	2-3/16
806	3/4	1/4	2-1/4
808	1	1/4	2-1/4

NEW

TOOL BITS & HOLDERS

CARBIDE-TIPPED SINGLE-POINT BRAZED TOOL BITS

**RIGHT HAND CUTS FROM RIGHT TO LEFT
LEFT HAND CUTS FROM LEFT TO RIGHT**

**GRADE C-2 for cast iron and non-ferrous materials
GRADE C-6 for steel and steel alloys.**

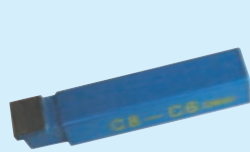

Style C

(Inch) Size	OAL	Style C Tool Style	C-6 Item#	Price(F)
1/4	2	C-4	2008-1104	2.09
5/16	2-1/4	C-5	2008-1105	2.51
3/8	2-1/2	C-6	2008-1106	2.71
1/2	3-1/2	C-8	2008-1108	3.90

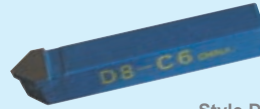

Style D

(Inch) Size	OAL	Style D Tool Style	C-6 Item#	Price(F)
1/4	2	D-4	2008-1204	2.15
3/8	2-1/2	D-6	2008-1206	2.74
1/2	3-1/2	D-8	2008-1208	3.90



Style A

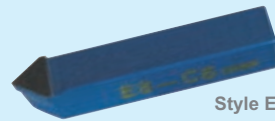

Style E

(Inch) Size	OAL	Style E Tool Style	C-6 Item#	Price(F)
1/4	2	E-4	2008-1304	2.10
5/16	2-1/4	E-5	2008-1305	2.36
3/8	2-1/2	E-6	2008-1306	2.58
1/2	3-1/2	E-8	2008-1308	3.90
5/8	4	E-10	2008-1310	5.07

Style A (Inch)		Right Hand					Left hand				
Size	OAL	Tool Style	C-2 Item#	Price (F)	C-6 Item#	Price (F)	Tool Style	C-2 Item#	Price (F)	C-6 Item#	Price (F)
1/4	2	AR-4	2008-0014	2.09	2008-0004	2.09	AL-4	2008-1014	2.09	2008-1004	2.10
5/16	2-1/4	AR-5	2008-0015	2.60	2008-0005	2.53	AL-5	2008-1015	2.41	2008-1005	2.44
3/8	2-1/2	AR-6	2008-0016	2.46	2008-0006	2.46	AL-6	2008-1016	2.46	2008-1006	2.46
1/2	3-1/2	AR-8	2008-0018	3.90	2008-0008	3.90	AL-8	2008-1018	3.75	2008-1008	3.75
5/8	4	AR-10	2008-0020	5.62	2008-0010	5.46	AL-10	2008-1020	5.46	2008-1010	5.46
3/4	4-1/2	AR-12	-----		2008-0012	6.19					

8PC HSS LATHE TURNING TOOL SETS

- Square shank sizes.
- Manufactured from HSS (M-2) material.
- Shanks are heat treated and ground.

Set Includes:

- No.1 Left-Hand Turning Tool (80°),
 - No.2 Right-Hand Turning Tool(80°),
 - No.3 Straight Finishing Tool, No.4 Corner (45°) Tool,
 - No.5 Parting Tool, No.6 Boring Tool,
 - No.7 Threading (60°) Tool, No.8 Corner (60°) Tool.
- Fitted Case.



Item #	Shank	Shank Length	Price (F)
2006-9022	1/4	2-1/2	44.14
2006-9024	5/16	3-1/8	47.19
2006-9026	3/8	4	55.23
2006-9028	1/2	4	84.37

TURNING TOOL HOLDERS-For Use With Rocker Style Turning Tool Holders

- Accurately machined and carefully heat-treated, these tool holders feature a relieved cutter bit hole to assure proper seating of tool bits, thereby reducing breakage. These holders are for use with high speed steel tool bits.

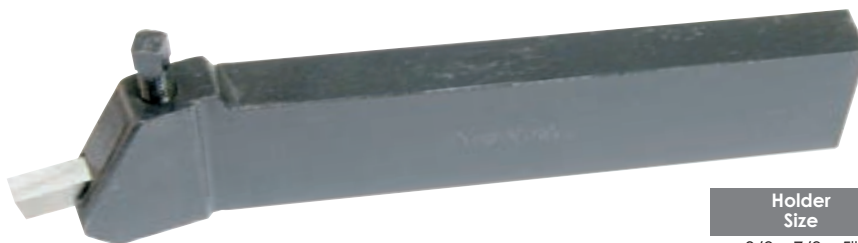

RIGHT HAND

Limited Supply!

Tool Bit NOT Included

Holder Size	Tool Bit Size	RH Offset Item#	Price (F) Ea.
3/8 x 7/8 x 5"	1/4"	2206-0375	38.57
1/2 x 1-1/8 x 6"	5/16"	2206-0500	36.31
5/8 x 1-3/8 x 7"	3/8"	2206-0625	48.32
3/4 x 1-5/8 x 8"	7/16"	2206-0750	56.68

SQUARE TOOL BITS - HSS & COBALT GROUND

- **M2 HIGH SPEED STEEL** A fine general purpose ground tool bits show exceptional result on mild steel, alloys and tool steels. This tool bit makes a superior finishing tool.
- **COBALT** Superior types of high speed steel which will work better where high heat is present. Used for heavy cuts in hard materials.

REGULAR LENGTH

Size (Inch) SQ x OAL	HSS Item#	Price (F)	M42 8% Cobalt Item#	Price (F)
1/8 x 2-1/2	2000-0001	2.38	2000-0041	4.29
3/16 x 2-1/2	2000-0002	2.48	2000-0042	4.59
1/4 x 2-1/2	2000-0003	2.31	2000-0043	4.37
5/16 x 2-1/2	2000-0004	3.14	2000-0044	6.35
3/8 x 3	2000-0005	4.98	2000-0045	9.38
7/16 x 3-1/2	2000-0006	7.69	2000-0046	13.72
1/2 x 4	2000-0007	10.20	2000-0047	22.33
5/8 x 4-1/2	2000-0008	17.89	2000-0048	37.58
3/4 x 5	2000-0009	27.62	2000-0049	56.65
1 x 7	2000-0011	64.32	2000-0051	121.12



EXTRA LONG

Size (Inch) SQ x OAL	HSS Item#	Price (F)	M35 5% Cobalt Item#	Price (F)
1/4 x 4	2000-0071	3.62	2000-0020	5.35
1/4 x 6	2000-0072	5.45	2000-0021	9.97
1/4 x 8	2000-0073	7.19	2000-0022	10.45
5/16 x 6	2000-0075	7.26	2000-0025	10.40
3/8 x 4	2000-0077	6.60	2000-0027	9.83
3/8 x 6	2000-0078	10.10	2000-0028	15.20
3/8 x 8	2000-0079	13.18	2000-0029	18.23
1/2 x 6	2000-0083	15.04	2000-0060	22.90

RECTANGULAR TOOL BITS - HSS



HIGH SPEED STEEL

Size (Inch)	Item#	Price (F)
1/4 x 3/8 x 3	2000-0203	4.19
1/4 x 1/2 x 4	2000-0220	6.99
1/4 x 3/4 x 5	2000-0235	11.42
3/8 x 3/4 x 5	2000-0248	16.93
3/8 x 1-1/4 x 6	2000-0252	33.05
1/2 x 3/4 x 5	2000-0257*	22.19

*Limited Supply

ROUND TOOL BITS - HSS



HIGH SPEED STEEL

Size (Inch)	Item#	Price (F)
1/8x2-3/4	2000-0331	0.66
3/16x3-1/2	2000-0353	1.35
1/4x4	2000-0377	2.68

Size (Inch)	Item#	Price (F)
3/8x5	2000-0385	7.41
1/2x6	2000-0389	12.68

FLY CUTTERS - Morse Taper & R8

- A fly cutter usually has two cutting heads and it is able to cut with a constant depth to face any surface to obtain a uniform surface.
- Utilizes standard tool bits.
- Counter balanced.
- Made of durable hardened steel.



Morse Taper
4006-0022 Shown



R8 4002-0018 Shown

INDIVIDUALS

Item#	Shank	Diameter of Head (In)	Fit Tool Bit (In)	Drawbar Thread	Price (F)
4006-0022	MT2	1.5	3/16	3/8-16	25.96
4006-0023	MT3	1.5	1/4	1/2-13	29.21
4002-0018	R8	2.5	5/16	-	36.00

3PC FLY CUTTER SETS - Straight Shank

- Utilizes standard tool bits.
- Counter balanced.
- Made of durable hardened steel.
- Cuts flat and smooth surface with a single cut.



Item#	Set	Diameter Tool Bit Head (In)	Shank (In)	Fit (In)	Price (F)
4002-0001	3	3/4	1/2	3/16	36.32
		1-1/8		1/4	
		1-1/2		5/16	
4002-0002	3	1-1/2	3/4	5/16	49.76
		2		5/16	
		2-1/2		5/16	
4002-0003	3	1-1/2	3/4	3/8	64.35
		2		3/8	
		2-1/2		1/2	

BORING BARS & SETS

COBALT (M42) BORING BAR SETS

- One piece cobalt structure to give more boring accuracy and longer life.
- All purpose.
- All shanks are held 0.000~0.005" from the nominal size.
- **COBALT** used for boring in tough high tensile strength materials like stainless steel, titanium and inconel.

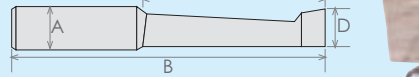

Item#	B (In) Length	C (In) Bore Depth	D (In) Min.bore
1001-0033 (8pc/set)	2	3/4	1/4
	2-3/8	1-1/8	1/4
	2-3/4	1-1/2	5/16
	2-3/16	15/16	3/8
	2-21/32	1-13/32	3/8
	3-1/8	1-7/8	3/8
1001-0035 (10pc/set)	2-3/8	1-1/8	7/16
	3-15/16	1-11/16	7/16
	2-1/8	5/8	5/16
	2-1/4	3/4	5/16
	2-5/8	1-1/8	5/16
	3	1-1/2	5/16
1001-0036 (10pc/set)	2-5/8	1-1/8	7/16
	3-3/16	1-11/16	7/16
	3-3/4	2-1/4	7/16
	3	1-1/2	9/16
	3-3/4	2-1/4	9/16
	4-1/2	3	9/16

8 PC SET
3/8" SHANK
1001-0033
\$94.67
(E)

M42 8% COBALT
MADE OF SOLID COBALT

10 PC SET
1/2" SHANK
1001-0036
\$126.64
(E)

CARBIDE-TIPPED BORING BAR SETS

- Quality tool designed to be used as a boring tool bit.
- All shanks are held to 0.000 - 0.0005" from the nominal size.
- Shanks are made of special heat treated alloy steel.
- Three lengths for each minimum bore size.

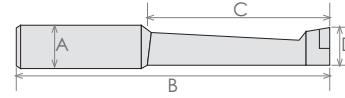

GRADE C-6
FOR ALL STEEL AND ALL PURPOSE

C-6 Item#	A Shank Dia. (In)	Set PC.	B (In) Length	C (In) Bore Depth	D (In) Min.bore	Price(F)
1001-0001	3/8	9	2	3/4	5/16	22.26
			2-3/8	1-1/8	5/16	
			2-3/4	1-1/2	5/16	
			2-3/16	15/16	3/8	
			2-21/32	1-13/32	3/8	
			3-1/8	1-7/8	3/8	
1001-0002	1/2	9	2-3/8	1-1/8	7/16	32.58
			2-5/8	1-1/8	7/16	
			3	1-1/2	5/16	
			2-5/8	1-1/8	7/16	
			3-3/16	1-11/16	7/16	
			3-3/4	2-1/4	7/16	
1001-0003	5/8	12	3	1-1/2	5/16	45.54
			2-5/8	1-1/8	7/16	
			3-3/16	1-11/16	7/16	
			3-3/4	2-1/4	7/16	
			3	1-1/2	9/16	
			3-3/4	2-1/4	9/16	
1001-0004	3/4	12	2-1/4	3/4	5/16	50.73
			2-5/8	1-1/8	5/16	
			3	1-1/2	5/16	
			2-5/8	1-1/8	7/16	
			3-3/16	1-11/16	7/16	
			3-3/4	2-1/4	7/16	
1001-0005	1	7	3	3/4	9/16	112.32
			5-3/4	3-3/4	11/16	
			6-1/2	4-1/2	7/8	
			6-1/2	4-1/2	1-1/16	
			7-3/4	5-3/4	1-1/4	
			8-1/4	6-1/2	1-1/2	

DOUBLE-END BORING BARS & SETS

- Machined from selected steel for greater strength and rigidity.
- Broached holes accept standard tool bits.
- Black oxide finish.
- Bars have one 45° end and one 90° end.



Tool Bits Not Included

Item#	Bar Dia.	Bar OAL	Bit Size	Bit Type	Price (F)
1015-0250	1/4"	5	5/32	Round	9.65
1015-0312	5/16"	5	3/16	Round	11.35
1015-0375	3/8"	6	3/16	Round	13.87
1015-0500	1/2"	6	3/16	Square	16.07
1015-0502	1/2"	9	3/16	Square	12.77
1015-0561	9/16"	6-3/4	3/16	Square	11.54
1015-0562	9/16"	9	3/16	Square	13.43
1015-0564	9/16"	6-3/4	1/4	Square	11.54
1015-0625	5/8"	10	1/4	Square	19.38
1015-0748	3/4"	8	1/4	Square	16.87
1015-0750	3/4"	12	1/4	Square	22.82
1015-0938	15/16"	9	5/16	Square	26.12
1015-1000	1"	12	5/16	Square	34.47
1015-1001	1"	12	1/4	Square	27.86
1015-1002	1"	12	3/8	Square	30.01
1015-1004	1-1/8"	14	7/16	Square	49.58
1015-1250	1-1/4"	16	1/2	Square	73.44
1015-1500	1-1/2"	18	1/2	Square	88.84



SETS

Item#	No. of Pieces	Includes	Price (F)
1001-0007	4	1015-0250, 1015-0312, 1015-0375 & 1015-0500	41.44
1001-0008	5	1015-0250, 1015-0375, 1015-0500, 1015-0625 & 1015-0750	88.36
1001-0010	5	1015-0375, 1015-0500, 1015-0625, 1015-0750 & 1015-1000	93.16

82° INDEXABLE COUNTERSINK & CHAMFER TOOLS



- Deburr and countersink large diameter holes.
- Positive rake for smooth cutting without chatter.
- Carbide indexable tool, so re-sharpening tool needed.
- 7° relief.



Item#	Max. Cutting Dia.	Min. Cutting Dia.	Shank Dia.	No. of Inserts	Insert Used	Screw	Torx Wrench	Price (F)
2001-0036	3/4"	1/4"	1/2"	1	TC_32.5	M4x8	T15	31.15
2001-0038	1-3/4"	1/2"	1/2"	1	SC_43	M5x10	T20	42.82
2001-0040	2-1/2"	1-1/4"	3/4"	1	SC_43	M5x10	T20	50.71

INSERTS - Replacement

Item #	Size	Price (F)
6004-9031	TCMT32.51	5.83
6004-4432	SCMT432	5.78

SCREWS - Replacement

Item #	Size	Price (F)
2100-0069	M4x8	4.40
2100-0075	M5x10	5.39

TORX WRENCHES - Replacement

Item #	Size	Price (F)
2100-0095	T15	3.10
2100-0096	T20	3.10

3PC INDEXABLE COUNTERSINK & CHAMFERING TOOL SETS

- Use for deburring and countersinking large diameter holes.
- Positive rake for smooth cutting without chatter.
- Carbide indexable tool so no tool resharping is needed.
- 7° relief.

Set Includes 1 of Each: 1/4x3/4x1/2" shank, 1/2x1-3/4x1/2" shank, 1-1/4x2-1/2x3/4" shank, C-6 inserts & wrenches (T15,T20)



Item#	Degree	Max. Cutting Dia.	Min. Cutting Dia.	Shank Dia.	No. of Inserts	Insert Used	Screw	Torx Wrench	Price (E)
2001-0010	60°	3/4"	1/4"	1/2"	1	TC_32.5	M4x8	T15	119.79
2001-0011	82°	1-3/4"	1/2"	1/2"	1	SC_43	M5x10	T20	119.79
2001-0012	90°	2-1/2"	1-1/4"	3/4"	1	SC_43	M5x10	T20	117.13

INSERTS - Replacement

Item #	Size	Price (F)
6004-9031	TCMT32.51	5.83
6004-4432	SCMT432	5.78

SCREWS - Replacement

Item #	Size	Price (F)
2100-0069	M4x8	4.40
2100-0075	M5x10	5.39

TORX WRENCHES - Replacement

Item #	Size	Price (F)
2100-0095	T15	3.10
2100-0096	T20	3.10

45° INDEXABLE CHAMFERING END MILLS -Accepts SPMT Carbide Insert

- Straight shank.
- Inserts are not included.



Item#	Max. Cutting Dia.	Min. Cutting Dia.	Shank Dia.	OAL	No. of Inserts	Use Insert	Screw	Torx Wrench	Price (F)
2076-0001	1"	0.528"	3/4"	3-3/8"	2	SP_32.5	M4x10	T15	37.94
2076-0003	1-1/8"	0.652"	3/4"	3-3/8"	2	SP_32.5	M4x8	T15	38.93
2076-0006	1-1/4"	0.776"	3/4"	3-3/8"	2	SP_32.5	M4x10	T15	42.34
2076-0010	1-1/2"	1.025"	1"	3-1/2"	3	SP_32.5	M4x10	T15	55.90
2076-0013	1-3/4"	1.274"	1-1/4"	3-1/2"	3	SP_32.5	M4x10	T15	48.96
2076-0016	2"	1.522"	1-1/2"	4"	4	SP_32.5	M4x10	T15	62.19

INSERTS - Optional

Item #	Size	Price (F)
6018-3251	SPMT32.51	8.50
6018-3252	SPMT32.52	8.50

SCREWS - Replacement

Item #	Size	Price (F)
2100-0069	M4x8	4.40
2100-0074	M4x10	5.39

TORX WRENCH - Replacement

Item #	Size	Price (F)
2100-0095	T15	3.10

INDEXABLE CUTTERS

INDEXABLE T-SLOT CUTTERS

Accepts CCMT Carbide Inserts

- 7° relief.
- Setting rake 90°.
- For milling, "T" slotting, bottom shouldering & side slotting.
- Weldon shank.

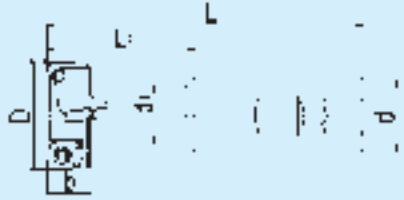

INSERTS NOT INCLUDED

Item#	Cutting Dia. D	Cutter Thickness b	Shank Dia. d	OAL L	Neck Dia. d1	No. of Inserts	Insert Used	Screw	Torx Wrench	Price (F)
2077-0500	31/32"	25/64"	3/4"	3-3/4"	17/32"	4	CC_ _21.5_	M2.5x6	T8	77.88
2077-0502	5/8"	17/32"	1"	4-3/8"	41/64"	4	CC_ _32.5_	M4x8	T15	75.43
2077-0504	1-15/32"	5/8"	1"	4-3/4"	25/32"	4	CC_ _32.5_	M4x10	T15	90.65
2077-0506	1-27/32"	53/64"	1-1/4"	5-1/8"	1-1/32"	4	CC_ _43_	M5x12	T20	102.62

INSERTS - Optional

Item #	Size	Price (F)
6053-0111	CCMT21.51	7.11
6053-0112	CCMT21.51	7.11
6053-0221	CCMT32.51	8.25
6053-0222	CCMT32.52	8.25
6053-0432	CCMT432	10.98

SCREWS - Replacement

Item #	Size	Price (F)
2100-0070	M2.5x6	3.63
2100-0069	M4x8	4.40
2100-0074	M4x10	5.39
2100-0075	M5x10	5.39

TORX WRENCHES - Replacement

Item #	Size	Price (F)
2100-0092	T8	3.10
2100-0095	T15	3.10
2100-0096	T20	3.10

60° INDEXABLE DOVETAIL CUTTERS - Accepts TDEX Carbide Inserts

- Right hand cut.
- 60° angle, 15° clearance.
- For milling, roughing & finishing at high speeds & feeds.
- Inserts are not included.



INSERTS NOT INCLUDED

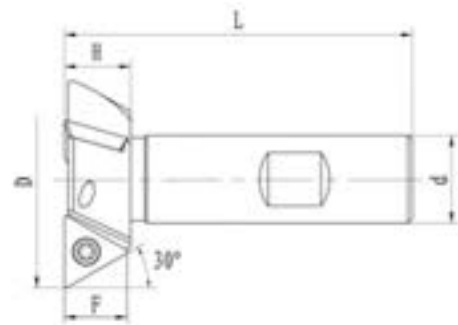

Item#	Cutting Dia. D	Shank Dia. d	OAL L	Cutting Depth F	Height H	No. of Insert	Insert Used	Screw	Torx Wrench	Price (F)
2075-0500	1/2"	3/8"	2.390"	0.32"	0.375"	1	TDEX21.5	M2.5x5	T8	34.34
2075-0502	3/4"	3/8"	2.390"	0.32"	0.375"	2	TDEX21.5	M2.5x6	T8	43.51
2075-0504	1"	1/2"	2.375"	0.32"	0.375"	3	TDEX21.5	M2.5x6	T8	55.49
2075-0506	1-3/8"	5/8"	2.862"	0.51"	0.550"	3	TDEX32	M4x10	T15	80.26
2075-0508	1-7/8"	3/4"	3"	0.51"	0.550"	3	TDEX32	M4x10	T15	89.86
2075-0510	2-1/4"	1"	3.5"	0.70"	0.750"	3	TDEX43	M5x11	T20	123.38
2075-0512	2-1/2"	1"	3.5"	0.70"	0.750"	3	TDEX43	M5x11	T20	132.94

INSERTS - Optional

Item #	Size	Price (F)
6062-0215	TDEX21.5	5.80
6062-0320	TDEX32	6.98
6062-0430	TDEX43	11.18

SCREWS - Replacement

Item #	Size	Price (F)
2100-0067	M2.5x5	3.63
2100-0070	M2.5x6	3.63
2100-0074	M4x10	5.39
2100-0079	M5x11	5.39

TORX WRENCHES - Replacement

Item #	Size	Price (F)
2100-0092	T8	3.10
2100-0095	T15	3.10
2100-0096	T20	3.10

MINI INDEXABLE END MILLS & SET

- Made of high grade tool steel hardened.
- Carbide triangle inserts included TPG222.

3 PC SET
8005-0020
\$61.22
 (E)
 1/2, 9/16 & 5/8"



TPG carbide inserts shown below.

Item#	Cutting Dia.	Shank Dia.	Body Length	OAL	No. of Insert	Inserts	Locking Screw	Price (E)
5820-0500	1/2"	1/2"	1"	3"	1	TP_22_	PM5x5	27.45
5820-0562	9/16"	1/2"	1"	3"	1	TP_22_	PM5x5	21.96
5820-0625	5/8"	1/2"	1"	3"	1	TP_22_	PM5x5	41.19

SCREW - Replacement

Item #	Size	Price (F)
2100-0105	PM5x5	5.48

90° SQUARE SHOULDER INDEXABLE END MILLS -Straight Shank

- For use in heavy duty milling application.
- Higher metal removal rates.
- Cutting rake angle 0°.
- Axial rake angle 0°.
- Setting angle 90°.
- Positive rake 90°.
- Right hand cut.
- Unique clamping mechanism. One clamp fits all sizes.
- Inserts included.

STRAIGHT SHANK



TPG carbide inserts shown below.

Item#	Cutting Dia. D	Shank Dia. d	OAL L	No. of Inserts	Inserts Used	Screw	Torx Wrench	Price (F)
5820-0750	3/4"	3/4"	3-1/4"	2	TP_22_	PM5x8	S3	43.65
5820-1000	1"	3/4"	3-1/4"	2	TP_22_	PM5x8	S3	38.94
5820-1250	1-1/4"	3/4"	3-3/8"	2	TP_32_	PM6x12	S4	45.38
5820-1500	1-1/2"	3/4"	3-1/2"	3	TP_32_	PM6x12	S4	64.48
5820-1750	1-3/4"	3/4"	3-1/2"	3	TP_32_	PM6x12	S4	57.84
5820-2000	2"	3/4"	3-3/4"	3	TP_43_	PM8x16	S5	69.64
5820-4000	2"	1"	4"	3	TP_43_	PM8x12	S5	70.32

SCREWS - Replacement

Item #	Size	Price (F)
2100-0105	PM5x8	5.48
2100-0106	PM6x12	5.48
2100-0108	PM8x12	5.48

R8 INDEXABLE END MILLS & SET

- For use in heavy duty milling application.
- Higher metal removal rates.
- Unique clamping mechanism. One clamp fits all sizes.
- Inserts included.

R8 SHANK

TPG carbide inserts shown below.



Individuals

Item#	Cutting Dia.	Shank Dia.	OAL	No. of Inserts	Insert Used	Locking Screw	Torx Wrench	Price (E)
1006-0005	1"	R8	5-9/16"	2	TP_22_	PM5x8	S3	45.19
1006-0006	1-1/4"	R8	5-9/16"	2	TP_32_	PM6x12	S4	49.15
1006-0011	1-1/2"	R8	5-9/16"	3	TP_32_	PM6x12	S4	58.92
1006-0012	2"	R8	6"	3	TP_32_	PM6x12	S4	78.21

SCREWS - Replacement

Item #	Size	Price (F)
2100-0105	PM5x8	5.48
2100-0106	PM6x12	5.48

3 PC SET
5820-0001
\$202.05
 (E)
 1, 1-1/4 & 1-1/2"

TPG - POSITIVE RAKE CARBIDE INSERTS

GRADE C-2 FOR CAST IRON AND GENERAL PURPOSE
GRADE C-6 FOR ALL STEEL AND GENERAL PURPOSE

- Single sided without chipbreaker.
- Suitable for difficult to cut materials.
- 11° relief angle.

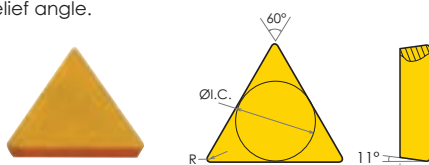

10 PC PER PACKAGE

*Limited Supply

Insert No.	I.C.	(Inch)	R	Uncoated C-2 Item#	C-2 Price (F)	Uncoated C-6 Item#	C-6 Price (F)	TIN Coated (C-6) Item#	(C-6) Price (F)
TPG-21.51	1/4	.094	1/64	-----	-----	6020-1121	4.81	6020-1121	4.81
TPG-221	1/4	1/8	1/64	6020-2221	3.34	6020-0221	3.34	6020-1221	5.56
TPG-222	1/4	1/8	1/32	6020-2222	3.34	6020-0222	3.34	6020-1222	5.28
TPG-223	1/4	1/8	3/64	6020-2223	5.13	6020-0223	4.90	6020-1223	5.28
TPG-32.51	3/8	5/32	1/64	-----	-----	6020-1122*	2.86	6020-1122*	2.86
TPG-321	3/8	1/8	1/64	6020-2321	4.18	6020-0321	4.01	6020-1321	6.89
TPG-322	3/8	1/8	1/32	6020-2322	4.01	6020-0322	4.01	6020-1322	6.89
TPG-323	3/8	1/8	3/64	6020-2323	4.18	6020-0323	4.01	6020-1323	6.89
TPG-324	3/8	1/8	1/16	6020-2324	4.01	6020-0324	4.18	6020-1324	6.89
TPG-431	1/2	3/16	1/64	6020-2431	8.38	6020-0431*	6.37	6020-1431*	8.65
TPG-432	1/2	3/16	1/32	6020-2432	-----	6020-0432*	6.37	6020-1432*	10.01
TPG-433	1/2	3/16	3/64	-----	-----	6020-0433*	6.37	6020-1433*	10.01
TPG-434	1/2	3/16	1/16	6020-2434*	34.52	6020-0434*	6.37	6020-1434*	8.66

INDEXABLE END MILLS

SQUARE SHOULDER INDEXABLE END MILLS - Accepts APKT(10mm) Carbide Insert

- 90° square shoulder milling
- Used for slotting and peripheral milling
- Uses standard APKT-1003 inserts (not included)
- Excellent alternative to HSS, cobalt and carbide end mills for heavy material removal rates

SQUARE SHOULDER

Item#	Cutter Dia.	Shank Dia.	(Inch) OAL	No of Inserts	Use Insert	Screw	Torx Wrench	Price (E)
5822-0375	3/8	1/2	3"	1	APKT1003	M2.5x6	T8	40.36
5822-0500	1/2	5/8	3-1/4"	1	APKT1003	M2.5x6	T8	37.94
5822-0625	5/8	5/8	3-1/4"	2	APKT1003	M2.5x6	T8	41.93
5822-0750	3/4	3/4	3-1/4"	3	APKT1003	M2.5x6	T8	43.92
5822-1000	1	1	3-3/2"	4	APKT1003	M2.5x6	T8	65.06
5822-1250	1-1/4	1-1/4	3-3/4"	5	APKT1003	M2.5x6	T8	73.95
5822-1500	1-1/2	1-1/2	4-1/4"	6	APKT1003	M2.5x6	T8	81.05



INSERTS NOT INCLUDED



INSERT - Optional

Item #	Size	Price (F)
6010-4203	APKT1003	12.45

SCREWS - Replacement

Item #	Size	Price (F)
2100-0070	M2.5x6	3.63

TORX WRENCH - Replacement

Item #	Size	Price (F)
2100-0092	T8	3.10

3PC SQUARE SHOULDER INDEXABLE END MILL SET

- 90° square shoulder milling
- Used for slotting and peripheral milling
- Excellent alternative to HSS, cobalt and carbide end mills for heavy material removal rates
- Used standard APKT-1003 inserts (not included) with M2.5x6mm screw.

SQUARE SHOULDER

3 PC SET
5822-0360
\$107.00
 (F)

INSERTS NOT INCLUDED

Cutting Dia.	Shank Dia.	OAL	No. of Inserts	Insert Used	Screw	Torx Wrench
3/8"	1/2"	3"	1	APKT1003	M2.5x5mm	T8
1/2"	1/2"	3"	1	APKT1003	M2.5x5mm	T8
5/8"	1/2"	3"	2	APKT1003	M2.5x6mm	T8



INSERT - Optional

Item #	Size	Price (F)
6010-4203	APKT1003	12.45

TORX WRENCH - Replacement

Item #	Size	Price (F)
2100-0092	T8	3.10



SCREWS - Replacement

Item #	Size	Price (F)
2100-0067	M2.5x5	3.63
2100-0070	M2.5x6	3.63

SQUARE SHOULDER COOLANT-THRU INDEXABLE END MILLS - Accepts APKT(10mm) Carbide Insert

- Coolant thru.
- 90° square shoulder milling
- Used for slotting and peripheral milling
- Excellent alternative to HSS, cobalt and carbide end mills for heavy material removal rates
- Uses standard APKT-1003 inserts (not included).

INSERTS NOT INCLUDED

SQUARE SHOULDER

Item#	Cutting Dia. D	Shank Dia. d	OAL L	No. of Inserts	Use Insert	Screw	Torx Wrench	Price (F)
5822-1601	3/8"	1/2"	3"	1	APKT1003	M2.5x6	T8	47.83
5822-1603	1/2"	1/2"	3-1/4"	1	APKT1003	M2.5x6	T8	47.83
5822-1605	5/8"	1/2"	3-1/4"	2	APKT1003	M2.5x6	T8	73.65
5822-1606	3/4"	3/4"	3-1/2"	3	APKT1003	M2.5x6	T8	74.66
5822-1608	1"	3/4"	3-1/2"	4	APKT1003	M2.5x6	T8	89.88
5822-1700	1-1/4"	3/4"	3-3/4"	5	APKT1003	M2.5x6	T8	113.14



5822-1700 Shown



INSERT - Optional

Item #	Size	Price (F)
6010-4203	APKT1003	12.45

SCREW - Replacement

Item #	Size	Price (F)
2100-0070	M2.5x6	3.63

TORX WRENCH - Replacement

Item #	Size	Price (F)
2100-0092	T8	3.10

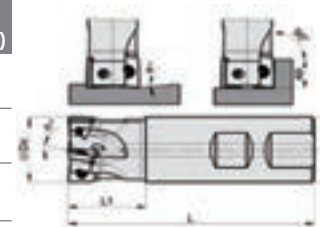

3PC SQUARE SHOULDER COOLANT-THRU INDEXABLE END MILL SET - Accepts APKT(10mm) Carbide Inserts

- Coolant thru.
- 90° square shoulder milling
- Used for slotting and peripheral milling
- Excellent alternative to HSS, cobalt and carbide end mills for heavy material removal rates
- Uses standard APKT-1003 inserts (not included) with M2.5x6mm screw.

SQUARE SHOULDER

3 PC SET
5822-1710
\$130.56
 (F)

INSERTS NOT INCLUDED

Cutting Dia. D	Shank Dia. d	OAL L	No. of Inserts	Insert Used	Screw	Torx Wrench
3/8"	1/2"	3"	1	APKT1003	M2.5x5mm	T8
1/2"	1/2"	3"	1	APKT1003	M2.5x5mm	T8
5/8"	1/2"	3"	2	APKT1003	M2.5x6mm	T8

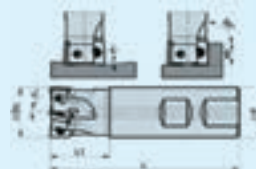

INSERT - Optional

Item #	Size	Price (F)
6010-4203	APKT1003	12.45

TORX WRENCH - Replacement

Item #	Size	Price (F)
2100-0092	T8	3.10

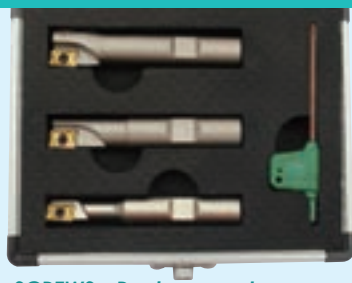

SCREWS - Replacement

Item #	Size	Price (F)
2100-0057	M2.5x5	4.38
2100-0070	M2.5x6	3.63

Helical COOLANT THRU INDEXABLE FACE MILLS - Accepts APKT (16mm) Carbide Inserts

- This 90° major cutting edge angle square shoulder milling cutter with helical have longer tool life and less cutting resistance.
- Insert(16mm) is NOT included.



INSERTS NOT INCLUDED

Item#	Cutting Dia. D	Arbor Hole d	Height H	No. of Flutes	No. of Inserts	Insert Used	Screw	Torx Wrench	Price (F)
2066-7000	2"	1"	2-3/8"	3	6	APKT1604	M4x10	T15	235.15
2066-7500	2-1/2"	1-1/4"	2-3/8"	4	8	APKT1604	M4x10	T15	268.11
2066-8000	3"	1-1/4"	2-3/8"	5	15	APKT1604	M4x10	T15	412.58

INSERT - Optional

Item #	Size	Price (F)
6010-4003	APKT1604	16.23

SCREW - Replacement

Item #	Size	Price (F)
2100-0074	M4x10	5.39

TORX WRENCH - Replacement

Item #	Size	Price (F)
2100-0095	T15	3.10

90° SQUARE SHOULDER INDEXABLE FACE MILLS - Clamp Style, Accepts TPG Carbide Inserts

- Setting angle 90°.
- Nickel coating.
- 11° positive triangular inserts allowing high depth of cut and feed per tooth.
- Radial rake angle +1°
- Axial rake +7°.
- The clamping system (screw) makes quick and easy insert mounting (indexing) and removal.

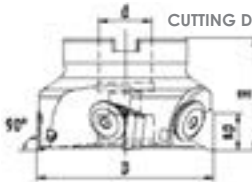

CUTTING DIAMETER: 2-3"

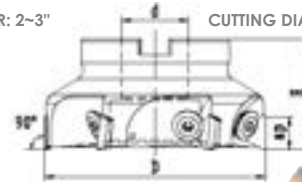

CUTTING DIAMETER: >3"

INSERTS NOT INCLUDED

SQUARE SHOULDER

Item#	Cutting Dia. D	Arbor Hole d	Height H	No. of Flutes	No. of Inserts	Shim	Shim Screw	Insert Screw	Hex Key Wrench	Price (F)
2061-3003	3"	1"	1.97"	5	TP__32_	TP16D	M3x6.5-D5	SM815.18	S2, S4	166.95
2061-4004	4"	1-1/2"	1.97"	5	TP__43_	TP22D	M3x6.5-D5	SM1018.22	S2, S4	209.12
2061-5005	5"	1-1/2"	2.48"	6	TP__43_	TP22D	M3x6.5-D5	SM1018.22	S2, S5	260.26



SHIM SCREWS - Replacement

Item #	Size	Price (F)
2100-0089	M3x6.5-D5	3.60

SCREWS - Replacement

Item #	Size	Price (F)
2100-0051	SM815.18	5.48
2100-0052	SM1018.22	5.48

HEX KEY WRENCHES - Replacement

Item #	Size	Price (F)
2100-1087	S2	3.20
2100-1089	S4	3.20
2100-1090	S5	3.20

SHIMS - Replacement

Item #	Size	Price (F)
2100-1100	TP16D	5.38
2100-1101	TP22D	6.96

See page 189 for carbide inserts

R8 SHELL END MILL HOLDERS

- Hardened and ground.

for Bridgeport® type mills

DRAWBAR END THREAD: 7/16" -20

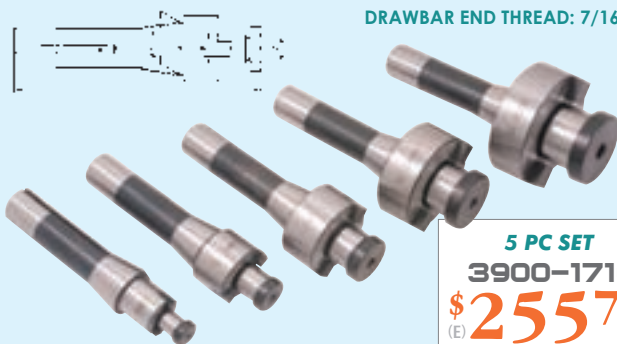

5 PC SET
3900-1710
\$255.75
(E)
1/2, 3/4, 1, 1-1/4, 1-1/2"

INDIVIDUALS

Item#	d	W (mm)	L (mm)	Dia. Range of Std. End Mill	Price (F)
3900-1711	1/2"	6.35	150	1-1/4 to 1-1/2"	50.16
3900-1712	3/4"	7.94	154	1-1/4 to 2-1/2"	50.47
3900-1713	1"	9.53	155	2-1/4 to 2-3/4"	58.38
3900-1714	1-1/4"	12.70	156	3 to 3-1/2"	62.71
3900-1715	1-1/2"	15.88	163	4 to 5"	68.88

CAT 40 "V" FLANGE SHELL END MILL HOLDERS

- CAT 40 Shell End Mill Holder.
- For CNC machines having CAT 40 taper spindles.
- Hardened and precision ground.

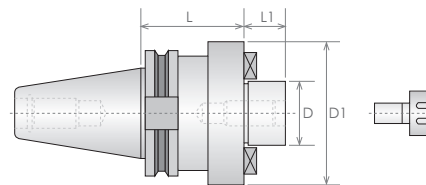

RETENTION KNOB THREAD: 5/8" -11

Item#	Dia. for Bore in Shell End Mill D	D1	Gage Length L	L1	Bore Thread	Price (F)
3900-4255	3/4"	1.5"	1.50"	0.69"	3/8"-24	82.34
3900-4257	1"	2.0"	2.00"	0.69"	1/2"-20	78.93
3900-4259	1-1/4"	2.5"	2.19"	0.69"	5/8-18	78.93
3900-4261	1-1/2"	3.0"	2.19"	0.94"	3/4"-16	87.58



INDEXABLE FACE MILLS

90° SQUARE SHOULDER R8 SHANK INDEXABLE END MILLS - Accepts APKT(16mm) Carbide Insert

- R8 shank.
- 90° cutting angle.
- Screwdown insert.
- Used for slotting and peripheral milling.
- **Insert is NOT included.**



SQUARE SHOULDER



INSERTS NOT INCLUDED

Item#	Cutting Dia. D	Shank Dia. d	OAL L	No. of Inserts	Use Insert	Screw	Torx Wr.	Price (F)
5822-3000	1"	R8	5-27/32"	2	APKT1604	M4x8	T15	57.07
5822-3250	1-1/4"	R8	5-27/32"	3	APKT1604	M4x8	T15	74.74
5822-3500	1-1/2"	R8	6-1/8"	4	APKT1604	M4x10	T15	111.07
5822-4000	2"	R8	6-1/8"	5	APKT1604	M4x10	T15	112.51
5822-4500	2-1/2"	R8	6-1/8"	6	APKT1604	M4x10	T15	123.82
5822-5000	3"	R8	6-1/4"	6	APKT1604	M4x10	T15	158.06

INSERT - Optional

Item #	Size	Price (F)
6010-4003	APKT1604	16.23

SCREWS - Replacement

Item #	Size	Price (F)
2100-0069	M4x8	4.40
2100-0074	M4x10	5.39

TORX WRENCH - Replacement

Item #	Size	Price (F)
2100-0095	T15	3.10

90° SQUARE SHOULDER INDEXABLE FACE MILLS - Accepts APKT Carbide Inserts

- This 90° major cutting edge angle square shoulder milling cutter is fitted with strong 11° positive rectangular inserts allowing high depth of cut and feed per tooth.
- Inserts not included

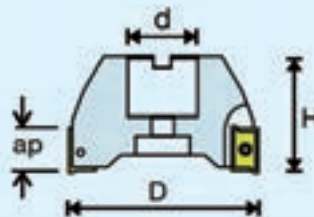

INSERTS NOT INCLUDED



Item#	Cutting Dia. D	Arbor Hole d	Height H	No. of Inserts	Insert Used	Screw	Torx Wrench	Price (F)
2063-2000	2"	3/4"	1.75"	5	APKT1003	M2.5x6	T8	98.31
2063-2500	2-1/2"	3/4"	2.00"	6	APKT1003	M2.5x6	T8	102.96
2063-3000	3"	1"	2.00"	7	APKT1003	M2.5x6	T8	126.58
2063-4000	4"	1-1/2"	2.00"	8	APKT1003	M2.5x6	T8	181.68
2063-5000	5"	1-1/2"	2.00"	8	APKT1003	M2.5x6	T8	196.82
2066-2000	2"	3/4"	1.75"	5	APKT1604	M4x10	T15	105.53
2066-2500	2-1/2"	3/4"	2.00"	6	APKT1604	M4x10	T15	109.39
2066-3000	3"	1"	2.00"	7	APKT1604	M4x10	T15	151.85
2066-4000	4"	1-1/2"	2.00"	8	APKT1604	M4x10	T15	179.09
2066-5000	5"	1-1/2"	2.00"	8	APKT1604	M4x10	T15	212.02

INSERTS - Optional

Item #	Size	Price (F)
6010-4203	APKT1003	12.45
6010-4003	APKT1604	16.23

SCREWS - Replacement

Item #	Size	Price (F)
2100-0070	M2.5x6	3.63
2100-0074	M4x10	5.39

TORX WRENCHES - Replacement

Item #	Size	Price (F)
2100-0092	T8	3.10
2100-0095	T15	3.10

90° SQUARE SHOULDER INDEXABLE END MILLS- Coolant -Thru - Accepts ANGX Carbide Inserts

- ANGX double-sided insert provides 4-cutting edges, has a bigger depth of cut(ap) value and economy.
- ANGX inserts with high precision cutting edge are more aggressive, have more cutting edges than APKT and are designed to improve shoulder milling surface finish.
- Double negative rake angle of the cutter body in combination with extra thick insert achieves double positive tool angle, reduces cutting resistance and improves impact resistance.
- Coolant-thru allows the cutting edge to cool and removes chips.

- This 90° major cutting edge angle square shoulder milling cutter is fitted with strong 11° positive rectangular inserts allowing high depth of cut and feed per tooth.
- **Insert is NOT included**



INSERTS NOT INCLUDED

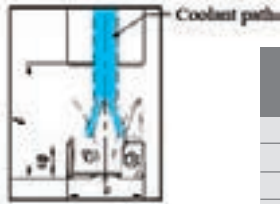

Coolant end mill shown

Item#	Cutting Diameter D1	Shank Size D	Head Length L2	OAL L	No. of Inserts	Ap1	Use Insert	Screw	Torx Wrench	Price (F)
5822-7750	3/4"	3/4"	1-1/4"	4"	1	0.441"	ANGX110508	M3x8	T10	66.36
5822-8000	1"	1"	1-1/2"	4.5"	2	0.441"	ANGX110508	M3x8	T10	91.05
5822-8250	1-1/4"	1-1/4"	1-21/32"	5"	3	0.441"	ANGX110508	M3x8	T10	120.42
5822-8500	1-1/2"	1-1/2"	1-21/32"	5"	4	0.441"	ANGX110508	M3x8	T10	149.74

Carbide inserts shown on page 171. Screws are shown on page 165.

90° SQUARE SHOULDER INDEXABLE FACE MILLS - Coolant -Thru - Accepts ANGX Carbide Inserts

- ANGX double-sided insert provides 4-cutting edges, has a bigger depth of cut(ap) value and economy.
- ANGX inserts with high precision cutting edge and are more aggressive, have more cutting edges than APKT and are designed to improve shoulder milling surface finish.
- Double negative rake angle of the cutter body in combination with extra thick insert achieves double positive tool angle, reduces cutting resistance and improves impact resistance.
- Coolant-thru allows the cutting edge to cool and removes chips.
- This 90° major cutting edge angle square shoulder milling cutter is fitted with strong 11° positive rectangular inserts allowing high depth of cut and feed per tooth.
- **Insert is NOT included.**



INSERTS NOT INCLUDED

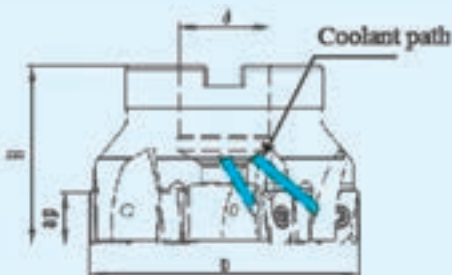

Coolant face mill shown



Item#	Cutting Diameter D	Arbor Size d	Height H	ap	Teeth	Uses Insert	Screw	Torx Wrench	Price (F)
2069-2000	2"	3/4"	1-3/4"	0.571"	4	ANGX150608PNR-GM	M4x11	T15	166.61
2069-3000	3"	1"	2"	0.571"	6	ANGX150608PNR-GM	M4x11	T15	213.77
2069-4000	4"	1-1/2"	2-1/2"	0.571"	8	ANGX150608PNR-GM	M4x11	T15	344.78
2069-5000	5"	1-1/2"	2-1/2"	0.571"	10	ANGX150608PNR-GM	M4x11	T15	412.18

Carbide inserts are shown on page 171. Screws are shown on page 165.

INDEXABLE FACE MILLS

45° INDEXABLE FACE MILLS - Accepts SCMT Carbide Inserts

- This positive cutter, 45° major cutting edge angle, is fitted with strong 7° positive square inserts.

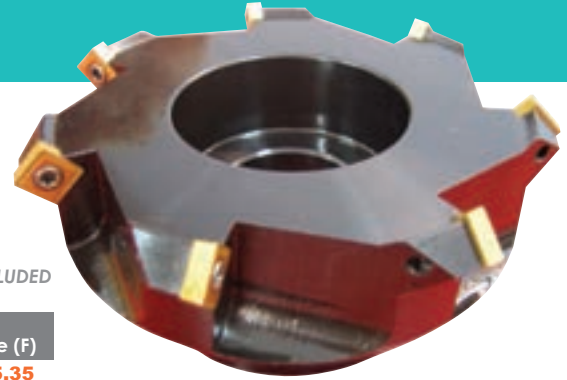

INSERTS NOT INCLUDED

Item#	Cutting Dia.	Arbor Hole	Height	No. of Inserts	Use Insert	Screw	Torx Wrench	Price (F)
2062-2000	2"	3/4"	1.57"	4	SC_432	M5x10	T20	125.35
2062-3000	3"	1"	1.97"	6	SC_432	M5x10	T20	169.08
2062-3500	3-1/2"	1"	1.97"	6	SC_432	M5x10	T20	226.25
2062-4000	4"	1-1/2"	1.97"	6	SC_432	M5x10	T20	232.50

INSERT - Optional

Item #	Size	Price (F)
6056-0432	SCMT432	10.98

SCREW - Replacement

Item #	Size	Price (F)
2100-0075	M5x10	5.39

TORX WRENCH - Replacement

Item #	Size	Price (F)
2100-0096	T20	3.10

45° INDEXABLE FACE MILLS - Accepts OCTAGON Carbide Inserts

- Octagonal double side insert with 16 cutting edges is the most economical insert on the market for face machining application.
- Negative radial rake angle and axial rake angle structure combined with thick ONHU insert body improves cutter overall resistance to impact and toughness.
- Insert is NOT included.



INSERTS NOT INCLUDED

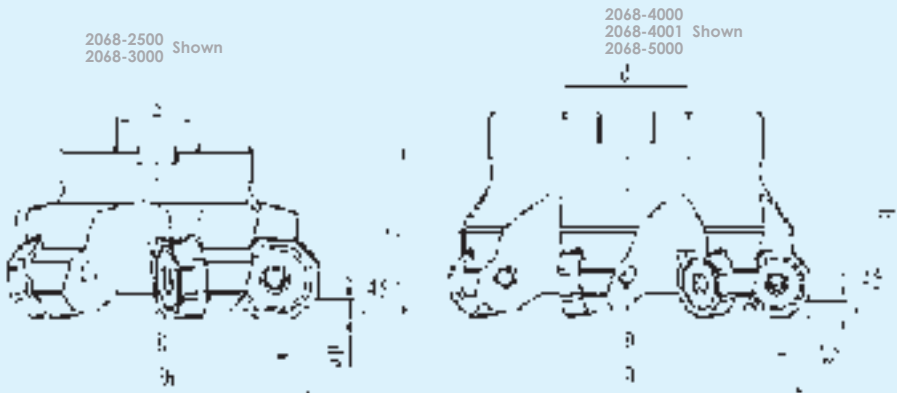

Item#	Cutting Dia. D	Arbor Hole d	Height H	No. of Inserts	Use Insert	Screw	Torx Wrench	Price (F)
2068-2500	2-1/2"	3/4"	1-3/4"	5	ONHU08	M5x14	T20	231.58
2068-3000	3"	1"	2"	6	ONHU08	M5x14	T20	240.94
2068-4000	4"	1-1/4"	2-1/2"	7	ONHU08	M5x14	T20	343.39
2068-4001	4"	1-1/2"	2-1/2"	7	ONHU08	M5x14	T20	307.45
2068-5000	5"	1-1/2"	2-1/2"	8	ONHU08	M5x14	T20	364.99

INSERT - Optional

Item #	Size	Price (F)
6063-0008	ONHU08	22.80

SCREW - Replacement

Item #	Size	Price (F)
2100-0077	M5x14	6.01

TORX WRENCH - Replacement

Item #	Size	Price (F)
2100-0096	T20	3.10

45° INDEXABLE FACE MILLS - Accepts SQUARE Carbide Inserts

- The close pitch, super positive, 45° major cutting edge angle milling cutter reduces cutting forces and permits high cutting speeds with limited power machines.

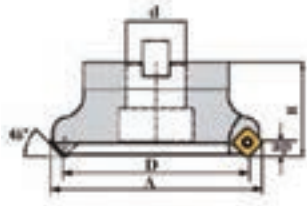

INSERTS INCLUDED



Item#	Cutting Diameter D	Arbor Hole d	Height H	No. of Inserts	Insert Used	Screw	Torx Wrench	Price (F)
2065-2000	2"	3/4"	1.57"	4	SE_43_AFTN	M5x10	T20	120.96
2065-2500	2-1/2"	3/4"	1.57"	5	SE_43_AFTN	M5x10	T20	166.10
2065-3000	3"	1"	1.97"	6	SE_43_AFTN	M5x10	T20	169.08
2065-4000	4"	1-1/2"	1.97"	6	SE_43_AFTN	M5x11	T20	218.02

INSERT - Optional

Item #	Size	Price (F)
6017-0432	SEHT-432	10.22

SCREWS - Replacement

Item #	Size	Price (F)
2100-0075	M5x10	5.39
2100-0079	M5x11	5.39

TORX WRENCH - Replacement

Item #	Size	Price (F)
2100-0096	T20	3.10

45° INDEXABLE FACE MILLS - Accepts SE Carbide Insert

- 45° lead angle allows an increase of feed rate by 50% over 90 degree face mill and also allows this face mill to be used on smaller horse power mills. It accepts industry standard SEAN / SEKN / SEKR 42 insert which has a positive 20° clearance angle.
- The insert pockets are designed to be 19° positive inclined to minimize vibration and allowing fast cutting and lowering cutting noise.
- Insert is NOT included.



2067-4000
2067-5000 Shown



2067-2000
2067-2500 Shown
2067-3000



INSERTS NOT INCLUDED

Item#	Cutting Dia. D	Arbor Hole d	Height H	No. of Inserts	Insert Used	Insert Screw	Shim	Shim Screw	Insert Hex Key	Shim Torx Wrench	Price(F)
2067-2000	2"	3/4"	1-57/64"	3	SE_42AFTN	SM815.18L	SE1203X	I86M4x7	S4	T15	107.59
2067-2500*	2-1/2"	3/4"	1-57/64"	4	SE_42AFTN	SM815.18L	SE1203X	I86M4x7	S4	T15	124.87
2067-3000	3"	1"	1-31/32"	5	SE_42AFTN	SM815.18L	SE1203X	I86M4x7	S4	T15	170.51
2067-4000*	4"	1-1/4"	1-31/32"	5	SE_42AFTN	SM815.18L	SE1203X	I86M4x9	S4	T15	167.88
2067-5000	5"	1-1/2"	2-31/64"	6	SE_42AFTN	SM815.18L	SE1203X	I86M4x9	S4	T15	310.68

*Limited Supply

INSERTS - Optional

Item #	Size	Price (F)
6016-1123	SEET/DM42	12.48
6016-0123	SEET/DR43	12.48

SCREWS - Replacement

Item #	Size	Price (F)
2100-0069	I86M4x7	4.40
2100-0071	I86M4x9	4.03

TORX WRENCH - Replacement

Item #	Size	Price (F)
2100-0095	T15	3.10

INSERT SCREW - Replacement

Item #	Size	Price (F)
2100-0051	SM815.18L	5.48

SCREW - Replacement

Item #	Size	Price (F)
2100-4200	SE1203X	4.52

INSERT HEX KEY - Replacement

Item #	Size	Price (F)
2100-1089	S4	3.20

THREADING INSERTS

CUTTING CARBIDE TOOLS

INTERNAL THREADING & GROOVING CARBIDE INSERTS-Metric Thread

Item#	Insert No.	I.C.	Screw Pitch	S	d	Grade	Price (F)
6006-1006	RT16.01N-1.25GM	3/8"	1.25	5/32"	0.173"	XAF799	14.84
6006-1007	RT16.01N-1.50GM	3/8"	1.50	5/32"	0.173"	XAF799	14.84
6006-1008	RT16.01N-1.75GM	3/8"	1.75	5/32"	0.173"	XAF799	14.84
6006-1009	RT16.01N-2.00GM	3/8"	2.00	5/32"	0.173"	XAF799	14.84
6006-1010	RT16.01N-2.50GM	3/8"	2.50	5/32"	0.173"	XAF799	14.84
6006-1011	RT16.01N-3.00GM	3/8"	3.00	5/32"	0.173"	XAF799	14.84

*Limited Supply

RIGHT HAND

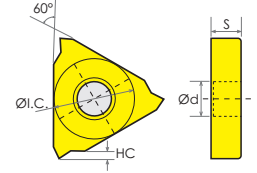

10 PC PER PACKAGE

EXTERNAL THREADING & GROOVING CARBIDE INSERTS-Metric Thread

Item#	Insert No.	I.C.	Screw Pitch	S	d	Grade	Price (F)
6006-3006	RT16.0W-1.25GM	3/8"	1.25	5/32"	0.173"	XAF799	14.84
6006-3007	RT16.0W-1.50GM	3/8"	1.50	5/32"	0.173"	XAF799	14.84
6006-3008	RT16.0W-1.75GM	3/8"	1.75	5/32"	0.173"	XAF799	14.84
6006-3009	RT16.0W-2.00GM	3/8"	2.00	5/32"	0.173"	XAF799	14.84
6006-3010	RT16.0W-2.50GM	3/8"	2.50	5/32"	0.173"	XAF799	14.84
6006-3011	RT16.0W-3.00GM	3/8"	3.00	5/32"	0.173"	XAF799	14.84

*Limited Supply

RIGHT HAND

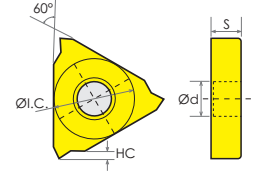

10 PC PER PACKAGE

INTERNAL THREADING & GROOVING CARBIDE INSERTS-Inch Thread

Item#	Insert No.	I.C.	Screw Pitch	S	d	Grade	Price (F)
6006-4008	RT16.01N-8UN	3/8"	8 TPI	5/32"	0.173"	XAF799	14.84
6006-4010	RT16.01N-10UN	3/8"	10TPI	5/32"	0.173"	XAF799	14.84
6006-4012	RT16.01N-12UN	3/8"	12 TPI	5/32"	0.173"	XAF799	14.84
6006-4014	RT16.01N-14UN	3/8"	14 TPI	5/32"	0.173"	XAF799	14.84
6006-4016	RT16.01N-16UN	3/8"	16 TPI	5/32"	0.173"	XAF799	14.84
6006-4018	RT16.01N-18UN	3/8"	18 TPI	5/32"	0.173"	XAF799	14.84
6006-4020	RT16.01N-20UN	3/8"	20 TPI	5/32"	0.173"	XAF799	14.84

RIGHT HAND

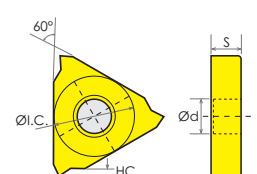

10 PC PER PACKAGE

EXTERNAL THREADING & GROOVING CARBIDE INSERTS-Inch Thread

Item#	Insert No.	I.C.	Screw Pitch	S	d	Grade	Price (F)
6006-4108	RT16.01N-8UN	3/8"	8 TPI	5/32"	0.173"	XAF799	14.84
6006-4110	RT16.01N-10UN	3/8"	10TPI	5/32"	0.173"	XAF799	14.84
6006-4112	RT16.01N-12UN	3/8"	12 TPI	5/32"	0.173"	XAF799	14.84
6006-4114	RT16.01N-14UN	3/8"	14 TPI	5/32"	0.173"	XAF799	14.84
6006-4116	RT16.01N-16UN	3/8"	16 TPI	5/32"	0.173"	XAF799	14.84
6006-4118	RT16.01N-18UN	3/8"	18 TPI	5/32"	0.173"	XAF799	14.84
6006-4120	RT16.01N-20UN	3/8"	20 TPI	5/32"	0.173"	XAF799	14.84

RIGHT HAND

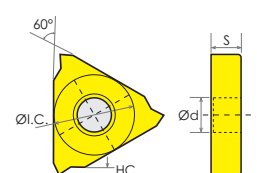

10 PC PER PACKAGE

INTERNAL (NPT) THREADING CARBIDE INSERTS-Pipe Thread

Item#	Insert No.	I.C.	Screw Pitch	S	d	Grade	Price (F)
6006-6008	RT16.001N-8NPT	.375"	8 TPI	.156"	0.173"	XAF799	14.84
6006-6011	RT16.001N-11.5NPT	.375"	11.5 TPI	.156"	0.173"	XAF799	14.84
6006-6014	RT16.001N-14NPT	.375"	14 TPI	.156"	0.173"	XAF799	14.84
6006-6018	RT16.001N-18NPT	.375"	18 TPI	.156"	0.173"	XAF799	14.84
6006-6027	RT16.001N-27NPT	.375"	27 TPI	.156"	0.173"	XAF799	14.84

RIGHT HAND

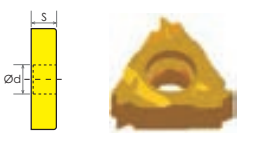
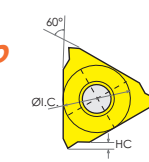

10 PC PER PACKAGE

EXTERNAL (NPT) THREAD CARBIDE INSERTS-Pipe Thread

Item#	Insert No.	I.C.	Screw Pitch	S	d	Grade	Price (F)
6006-6108	RT16.001W-8NPT	.375"	8 TPI	.156"	0.173"	XAF799	14.84
6006-6111	RT16.001W-11.5NPT	.375"	11.5 TPI	.156"	0.173"	XAF799	14.84
6006-6114	RT16.001W-14NPT	.375"	14 TPI	.156"	0.173"	XAF799	14.84
6006-6118	RT16.001W-18NPT	.375"	18 TPI	.156"	0.173"	XAF799	14.84
6006-6127	RT16.001W-27NPT	.375"	27 TPI	.156"	0.173"	XAF799	14.84

RIGHT HAND

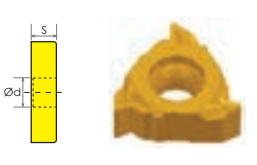
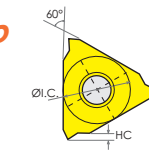

10 PC PER PACKAGE

See page 169 For grade information

INDEXABLE EXTERNAL THREADING TOOL HOLDERS

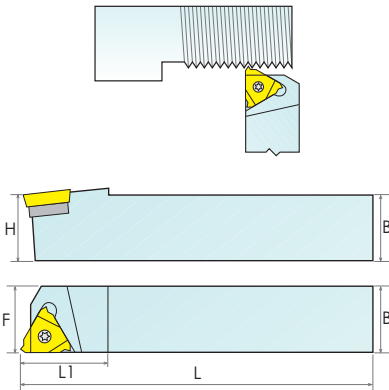

*Limited Supply

See page 165 & 166 for spare parts

RH Item#	Style	Shank BxB	(Inch) L	Insert I.C.	Insert	Insert Screw	Shim	Shim Screw	Wrench	Price (F)
2301-0375*	SER0375D16	3/8 x 3/8	2-1/2	3/8	16ER..	M3.5x12	LT16R-3.0	SDN535	T15+S3.5	57.36
2301-0500	SER0500F16	1/2 x 1/2	3-1/4	3/8	16ER..	M3.5x12	LT16R-3.0	SDN535	T15+S3.5	49.92
2301-0625	SER0625K16	5/8 x 5/8	5	3/8	16ER..	M3.5x12	LT16R-3.0	SDN535	T15+S3.5	57.91
2301-0750	SER0750K16	3/4 x 3/4	5	3/8	16ER..	M3.5x12	LT16R-3.0	SDN535	T15+S3.5	64.87
2301-1000	SER1000M16	1 x 1	6	3/8	16ER..	M3.5x12	LT16R-3.0	SDN535	T15+S3.5	69.89

INDEXABLE EXTERNAL THREADING TOOL HOLDER KITS

- Right hand external threads cut.
- AG60 inserts range 0.5~3.00mm/8~48 TPI
- A60 inserts range 0.5~1.5mm/16~48 TPI
- Complete with aluminium case.

- Kit includes:**
- 1-Tool Holder
 - 10-TiN Coated Carbide Insert
 - 1-Torx Wrench
 - Fitted Case

*Limited Supply

Item#	Style	Shank	(Inch) OAL	Insert I.C.	Insert	Insert Screw	Wrench	Price (F)
2301-1375*	SER0312D08	5/16	2.5	.197"	08ERA60	M2.5x6	T8	263.95
2301-1500	SER0375E11	3/8	3	1/4"	11ERA60	M2.5x7	T8	174.79
2301-1625	SER0500H11	1/2	4	1/4"	11ERA60	M2.5x7	T8	159.94
2301-1750	SER0625H16	5/8	4	3/8"	16ERAG60	M3.5x12	T15	172.04
2301-2000	SER0750K16	3/4	5	3/8"	16ERAG60	M3.5x12	T15	182.82



INDEXABLE INTERNAL & EXTERNAL THREADING TOOL HOLDER KITS

Kit includes:

- 1-Internal Tool Holder
- 1-External Tool Holder
- 3-IR (Internal) TiN Coated Carbide Insert
- 4-ER (External) TiN Coated Carbide Insert
- 1-Torx Wrench
- Fitted Case



*Limited Supply

See page 165 & 166 for spare parts

RH Item#	Style (INT & EXT)	Shank	Insert	Insert Screw	Shim Screw	Shim	Wrench	Price (F)
2301-2250*	SIR0250H06 & SER0250D06	1/4	06IR/06ER..	M2x5	-	-	T6	200.54
2301-2312*	SIR0312H08 & SER0312D08	5/16	06IR/08ER..	M2.5x6	-	-	T8	200.54
2301-2375*	SIR0375H11 & SER0375E11	3/8	11IR/11ER..	M2.5x6	-	-	T8	150.15
2301-2500	SIR0500K11 & SER0500F11	1/2	11IR/11ER..	M2.5x6	-	-	T8	177.70
2301-2625	SIR0625M16 & SER0625H16	5/8	16IR/16ER..	M3.5x8/M3.5x12	SDN535(EXT)	LT16R-3.0(EXT)	T15+S3.5	182.47
2301-2750	SIR0750P16 & SER0750K16	3/4	16IR/16ER..	M3.5x8/M3.5x12	SDN535 (EXT)	LT16R-3.0(EXT)	T15+S3.5	194.06

THREADING CARBIDE INSERTS/PARTIAL PROFILE 60°

- 60° V partial profile threading insert.
- Right hand cut.

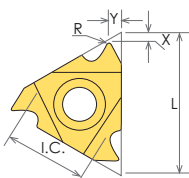

TIN COATED

10 PC PER PACKAGE

	Item#	Insert	I.C.	Pitch Range mm	TPI	L (in)	R (in)	X (in)	Y (in)	Price (F)
INTERNAL	6061-0156	06IRA60	.156"	0.5-1.25	48-20	.236	.002	.020	.024	20.36
	6061-0187	08IRA60	.188"	0.5-1.5	48-16	.315	.002	.024	.028	20.36
	6007-0008	11IRA60	1/4"	0.5~1.5	48~16	.435	.003	.031	.035	10.20
	6007-0015	16IRAG60	3/8"	0.5~3.0	48~8	.630	.003	.047	.035	10.30
	6007-0018	22IRN60	1/2"	3.5~5.0	5~7	.866	.010	.067	.098	17.18
EXTERNAL	6007-0002	06ERA60	.156"	0.5~1.25	48~20	.236	.002	.020	.024	21.53
	6007-0001	08ERA60	.197"	0.5~1.5	48~16	.315	.002	.024	.028	19.16
	6007-0004	11ERA60	1/4"	0.5~1.5	48~16	.435	.003	.031	.035	10.20
	6007-0012	16ERAG60	3/8"	0.5~3.0	48~8	.630	.003	.047	.035	10.20
	6007-0020	22ERN60	1/2"	3.5~5.0	5~7	.866	.016	.067	.098	17.00

CUTTING & CARBIDE TOOLS

INDEXABLE THREADING TOOLS

MINI INDEXABLE THREADING TOOL HOLDER KIT

- Right hand.
- Super for running at low speeds
- Threads all the way down in a blind hole
- 3 cutting edge on insert provides 3x tool life
- 06IR A60 insert range 48-20 TPI/ 0.5~1.25mm.
- 08IR A60 insert range 48-16 TPI/ 0.5~1.50mm.

Set Includes:

- 1-mini tool holder
- 10 -60° partial profile internal insert, TiN coated
- 1 - Torx wrench
- 1 -Aluminium fitted case



Limited Supply!



Item#	Shank Dia. D	D1	(Inch) L	L1	Min. Bore	Use Insert	Screw	Wrench	Price (F)
2305-0312	5/16	0.205	4	0.500	0.240	06IRA60	M2x3.5mm	T6	239.51
2305-0375	3/8	0.265	5	0.710	0.310	08IRA60	M2.5x5mm	T8	296.51
2305-0500	1/2	0.205	4	0.500	0.240	06IRA60	M2x3.5mm	T6	296.81
2305-0626	5/8	0.265	5	0.710	0.307	08IRA60	M2.5x5mm	T8	296.81

INDEXABLE INTERNAL THREADING TOOL HOLDERS

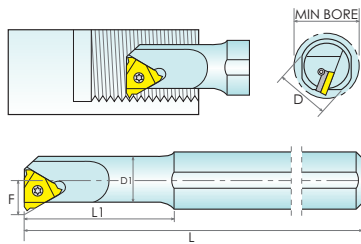

RH Item#	Style	Shank D (Inch)	Min. Bore F	Insert I.C.	Insert	Insert Screw	Wrench	Anvil Screw	Shim	Price (F)
2302-0375	SIR0375H11	3/8	4 .47 0.29	1/4	11IR..	M2.5x6	T8	---	---	56.09
2302-0500	SIR0500K16	1/2	5 .64 0.39	3/8	16IR..	M3.5x8	T15	---	---	64.08
2302-0625	SIR0625P16	5/8	7 .75 0.45	3/8	16IR..	M3.5x8	T15	---	---	76.06
2302-0750	SIR0750P16	3/4	7 1.00 0.51	3/8	16IR..	M3.5x8	T15	---	---	80.04
2302-0751	SIR0750P22	3/4	7 1.00 0.51	1/2	22IR..	M4x12-Ø6.8	T15	---	---	91.82
2302-1000	SIR1000R16	1	8 1.20 0.65	3/8	16IR..	M3.5x12	T15+S3.5	SDN535	LT16L-3.0	85.85

INDEXABLE INTERNAL THREADING TOOL HOLDER KITS

- Right hand internal threads cut.
- AG60 inserts range 0.5~3.00mm/8~48 TPI
- A60 inserts range 0.5~1.5mm/16~48 TPI
- Complete with aluminium case.

- **Kit includes:** 1-Tool Holder, 10-TiN Coated Carbide Insert, 1-Torx Wrench

Item#	Style	Shank	OAL	Insert I.C.	Insert	Insert Screw	Wrench	Price (F)
2302-1250	SIR0375H11	3/8	4	1/4	11IRA60	M2.5x6	T8	177.94
2302-1500	SIR0500K11	1/2	5	1/4	11IRA60	M2.5x6	T8	177.94
2302-1625	SIR0625M16	5/8	6	3/8	16IRAG60	M3.5x8	T15	224.87
2302-1787	SIR0750P16	3/4	7	3/8	16IRAG60	M3.5x8	T15	223.76



5PC INDEXABLE INTERNAL THREADING TOOL HOLDER SET

- Suitable for varied pitch internal threading.
- Supplied with fitted aluminium case.
- Carbide inserts are included for semi-finishing/roughing.

Specifications

Size in Set	Insert	OAL	Screw	Wrench
5/16	08IR A60	4"	M2.5x5mm	T6
3/8	11IRA A60	5"	M2.5x5mm	T6
1/2	11IRA A60	6"	M2.5x5mm	T6
5/8	16IR AG60	7"	M3.5x10mm	T15+S3.5
3/4	16IR AG60	10"	M3.5x10mm	T15+S3.5

5 PC SET
2305-1005
\$ **267.53**
(F)



MTVO STYLE EXTERNAL THREADING & GROOVING HOLDERS

- For OD threading and grooving
- Neutral rake.
- Right hand.
- Torx & Allen wrench included.



ALSO USES INSERTS: TNMA-NV, TNMC-NC, TPMC-NV

INSERT NOT INCLUDED

RH Item#	Holder Style	Shank	(Inch) OAL	Insert I.C.	Use Insert	Insert Screw	Clamp	Spring	Locking Screw	Torx Wr.	Allen Wr.	Price (F)
2304-1500	MTVOR08-3B	1/2x1/2	4-1/2	3/8	TNMA-32NV	M3.5x8	MTH0820	MTH0610	GB/T70.2 M6x20	T15	S4	49.08
2304-1750	MTVOR12-3B	3/4x3/4	4-1/2	3/8	TNMA-32NV	M3.5x8	MTH0820	MTH0610	GB/T70.2 M6x20	T15	S4	49.01
2304-1751	MTVOR12-4B	3/4x3/4	4-1/2	1/2	TNMA-43NV	M5X12	MTH0820	MTH0610	DLS5 M6x26	T20	S4	49.08
2304-2000*	MTVOR16-3D	1x1	6	3/8	TNMA-32NV	M3.5X8	MTH0820	MTH0610	DLS5 M6x26	T15	S4	54.78
2304-2001	MTVOR16-4D	1x1	6	1/2	TNMA-43NV	M5X12	MTH0820	MTH0610	DLS5 M6x26	T20	S4	56.97

*Limited Supply



Replacement Parts

Item#	Insert Screw	Price (F)	Item#	Locking Clamp	Price (F)	Item#	Locking Screw	Price (F)	Item#	Spring	Price (F)
2100-0073	M3.5x8	4.13	2100-0015	MTH0820	7.01	2100-0026	GB/T70.2 M6X20	3.77	2100-0100	MTH0610	3.46
2100-0076	M5X12	5.28				2100-0027	DLS5 M6X26	4.37			

TNMA THREADING CARBIDE INSERTS 0-Degree Rake, Precision Ground

- 60° "V"-threading.
- 0° Rake angle.
- Cylindrical thru hole.



Item#	Insert No.	I.C.	Pitch	Radius R	Thread Degree	Thick T	Hole d	Grade C6	Price (F)
6043-0375	TNMA-32NV	3/8	8 TPI Max.	.003~.005	60	.125"	.150"	TiN	8.43
6043-0500	TNMA-43NV	1/2	6 TPI Max.	.005~.008	60	.187"	.202"	TiN	13.08
6043-0005	TNMA-43NV	1/2	6 TPI Max.	.005~.008	60	.187"	.202"	Uncoated	10.55

10 PC PER PACKAGE

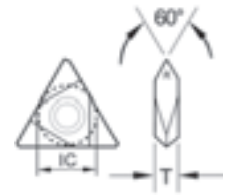

TPMC THREADING INSERTS 10-Degree Rake, Precision Ground

- 60° "V"-threading.
- 10° Rake angle.
- Double countersink thru hole.
- TiN coated.



*Limited Supply

Item#	Insert No.	I.C.	Pitch	Radius R	Thread Degree	Groove Width	Price (F)
6043-1375	TPMC-32NV	3/8	8 TPI Max.	.003~.005	60	.125"	12.15
6043-1500	TPMC-43NV	1/2	6 TPI Max.	.005~.008	60	.187"	15.43
6043-1625*	TPMC-54NV	5/8	4 TPI Max.	.005~.008	60	.250"	16.94

10 PC PER PACKAGE

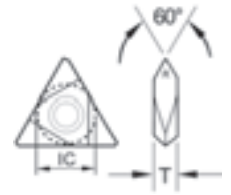

TNMC GROOVING CARBIDE INSERTS

- Right hand on two sides.
- Neutral rake angle.
- Double countersink thru hole.
- TiN coated.

TiN Coated



*Limited Supply

Item#	Insert No.	I.C. (In)	Pitch	Groove Width (In)	Groove Depth (In)	Price (F)
6043-0632	TNMC-32NGR031	0.375	8 TPI Max.	.031	.075	12.15
6043-0633	TNMC-32NGR062	0.375	8 TPI Max.	.062	.150	12.15
6043-0634	TNMC-32NGR094	0.375	8 TPI Max.	.094	.150	12.15
6043-0635	TNMC-32NGR125	0.375	8 TPI Max.	.125	.150	12.15
6043-0643	TNMC-43NGR062	0.500	6 TPI Max.	.062	.125	17.65
6043-0644	TNMC-43NGR094	0.500	6 TPI Max.	.094	.150	17.65
6043-0645	TNMC-43NGR125	0.500	6 TPI Max.	.125	.210	17.65
6043-0646*	TNMC-43NGR156	0.500	6 TPI Max.	.156	.210	14.63
6043-0647*	TNMC-43NGR187	0.500	6 TPI Max.	.187	.210	13.41
6043-0654*	TNMC-54NGR250	0.625	4 TPI Max.	.250	.210	13.80

INDEXABLE TOOL SETS

TOP NOTCH STYLE INTERNAL THREADING & GROOVING TOOLHOLDERS

- Right hand.
- Excellent all-purpose system for threading and grooving.
- Very strong insert design and wide insert selection and range.
- Clamping system draws the insert consistently back into the pocket for superior repeatability.
- Fully interchangeable with other similar "notch" type tools and inserts.
- Insert not included.

Right Hand Holder Use Left Hand Inserts

Insert Not Included

Item#	Holder #	D min.	L1	(Inch) D	F	(mm) D2	(mm) L2	CLAMP	Screw	Gage Insert Size	Price (F)
2301-3010	S10S-TNER2	1.000	10	0.625	.500	14.88	34	TNSN02B	M4X12	2	61.98
2301-3016	S16T-TNER3	1.375	12	1.000	.688	23.4	47.8	TNSN-3B	M5X16	3	83.04
2301-3020	S20U-TNER3	1.750	14	1.250	.875	29.75	50.6	TNSN-3B	M5X18	3	97.01
2301-3024	S24U-TNER3	2.000	14	1.500	1.000	35.1	50.6	TNSN-3B	M5X18	3	122.18

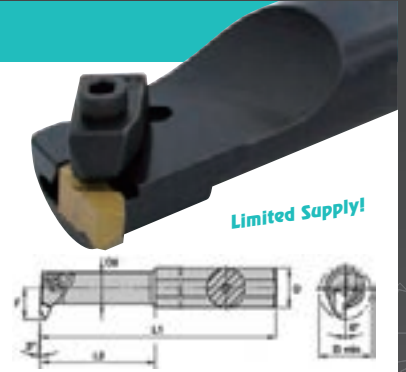

TOP NOTCH STYLE EXTERNAL THREADING & GROOVING TOOLHOLDERS

- Right hand.
- Excellent all-purpose system for threading and grooving.
- Very strong insert design and wide insert selection and range.
- Clamping system draws the insert consistently back into the pocket for superior repeatability.
- Fully interchangeable with other similar "notch" type tools and inserts.

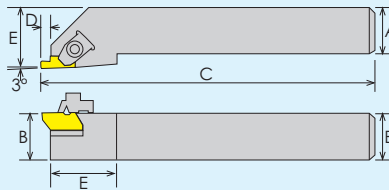

Right Hand Holder Use Right Hand Inserts

Item#	Holder #	A	B	C	(Inch) D	F	E	Clamp	Screw	Gage Insert Size	Shim	Shim Screw	Keys	Price (F)
2301-3108	TNSR08-2V	.50	.500	3.5	.138	.75	.75	TNSB-2B	M4x14	2	---	---	S2.5	37.01
2301-3112	TNSR12-2B	.75	.750	4.5	.138	1.00	.75	TNSB-2B	M4x14	2	TNSN-2Z	M2x4	S2.5 & T6	43.83
2301-3113	TNSR12-3B	.75	.750	4.5	.210	1.00	1.25	TNSB-3B	M5x18	3	TNSN-3A-3	M2.5x8	S3 & T8	45.55
2301-3116	TNSR16-3D	1	1.000	6.0	.210	1.25	1.25	TNSB-3B	M5x18	3	TNSN-3A	M2.5x8	S3 & T8	50.21
2301-3117	TNSR16-4D	1	1.000	6.0	.294	1.25	1.38	TNSB-3B	M5x18	4	TNSN-3A	M2.5x8	S3 & T8	52.30



NOTCH THREADING & GROOVING CARBIDE INSERTS

- Completely interchangeable with the *Kennametal TopNotch and the Teledyne Firth Notch systems.
- 60° Negative rake, natural.
- NT-600 parting profile general purpose threading inserts.
- NG-Grooving & Turning inserts.
- Grade: C5/TIC-65 coated, which is same as KENNAMETAL KC810, KC850, KC950, KC730
- Trademark of Kennametal.

GROOVING INSERTS

Grade C5/TIC 65

R=Right Hand
L=Left Hand



SPECIFICATIONS

Insert #	External TPI	Internal TPI
T/NT-2R/2L	8-36	7-20
T/NT-3R/3L	6-20	5-12
T/NT-4R/4L	4-20	4-12



THREADING INSERTS Grade C5/TIC 65

Item#	Insert #	R	B	(Inch) T	E	A	Gage Dia.	Price (F)
6062-5001	T/NT-2R	.003	.2661	.150	.075	.219	.1875	15.41
6062-5002	T/NT-2L	.005	.2661	.150	.075	.219	.1875	15.41
6062-5003	T/NT-3R	.005	.3999	.195	.098	.344	.3750	15.41
6062-5004	T/NT-3L	.008	.3999	.195	.098	.344	.3750	15.41
6062-5005	T/NT-4R	.005	.6293	.255	.128	.453	.3750	29.21
6062-5006	T/NT-4L	.008	.6293	.255	.128	.453	.3750	29.21

CLAMP

Item #	Style	Price (F)
2100-0011	TNSB-2B	7.15
2100-0010	TNSB-3B	7.15

Item#	Insert #	Groove Width R	W	B	(Inch) Depth of Cut T	E	A	Gage Dia.	Price (F)
6062-2030	T/NG-2031R	.002	.031	.2700	.150	.050	.219	.1875	13.54
6062-2031	T/NG-2031L	.005	.031	.2700	.150	.050	.219	.1875	13.54
6062-2046	T/NG-2047R	.002	.047	.2700	.150	.050	.219	.1875	13.54
6062-2047	T/NG-2047L	.005	.047	.2700	.150	.050	.219	.1875	13.54
6062-2061	T/NG-2062R	.005	.062	.2700	.150	.050	.219	.1875	13.54
6062-2062	T/NG-2062L	.010	.062	.2700	.150	.050	.219	.1875	13.54
6062-2093	T/NG-2094R	.005	.094	.2700	.150	.050	.219	.1875	13.54
6062-2094	T/NG-2094L	.010	.094	.2700	.150	.050	.219	.1875	13.54
6062-2124	T/NG-2125R	.005	.125	.2700	.150	.050	.219	.1875	13.54
6062-2125	T/NG-2125L	.010	.125	.2700	.150	.050	.219	.1875	13.54
6062-3046	T/NG-3047R	.005	.047	.4050	.195	.075	.344	.3750	14.98
6062-3047	T/NG-3047L	.010	.047	.4050	.195	.075	.344	.3750	14.98
6062-3061	T/NG-3062R	.005	.062	.4050	.195	.075	.344	.3750	14.98
6062-3062	T/NG-3062L	.010	.062	.4050	.195	.075	.344	.3750	14.98
6062-3077	T/NG-3078R	.005	.078	.4050	.195	.075	.344	.3750	14.98
6062-3078	T/NG-3078L	.010	.078	.4050	.195	.075	.344	.3750	14.98
6062-3087	T/NG-3088R	.005	.088	.4050	.195	.075	.344	.3750	14.98
6062-3088	T/NG-3088L	.010	.088	.4050	.195	.075	.344	.3750	14.98
6062-3093	T/NG-3094R	.005	.094	.4050	.195	.075	.344	.3750	14.98
6062-3094	T/NG-3094L	.010	.094	.4050	.195	.075	.344	.3750	14.98
6062-3124	T/NG-3125R	.005	.125	.4050	.195	.075	.344	.3750	14.98
6062-3125	T/NG-3125L	.010	.125	.4050	.195	.075	.344	.3750	14.98
6062-3155	T/NG-3156R	.005	.156	.4050	.195	.075	.344	.3750	14.98
6062-3156	T/NG-3156L	.010	.156	.4050	.195	.075	.344	.3750	14.98
6062-3188	T/NG-3189R	.005	.189	.4050	.195	.075	.344	.3750	14.98
6062-3189	T/NG-3189L	.010	.189	.4050	.195	.075	.344	.3750	14.98
6062-4124	T/NG-4125R	.005	.125	.6360	.255	.250	.453	.3750	29.62
6062-4125	T/NG-4125L	.010	.125	.6360	.255	.250	.453	.3750	29.62
6062-4188	T/NG-4189R	.020	.189	.6360	.255	.250	.453	.3750	29.62
6062-4189	T/NG-4189L	.025	.189	.6360	.255	.250	.453	.3750	29.62
6062-4249	T/NG-4250R	0.20	.250	.6360	.255	.250	.453	.3750	29.62
6062-4250	T/NG-4250L	.025	.250	.6360	.255	.250	.453	.3750	29.62

MINI-SYSTEM EXTERNAL GROOVING & CUT-OFF HOLDERS

INSERTS NOT INCLUDED

- Right hand shank external holder.
- Insert not included.
- Set Includes: 1pc- External Holder, 1pc-T10 Wrench, 1pc-Aluminum Case.
- Accepts NIKCOLE style inserts.
- For use with .019 to .125" thin inserts.
- Ideal for external grooving, threading, cut-off, turning & copying under .125" width.

RIGHT HAND HOLDER ONLY ACCEPT RIGHT HAND INSERTS

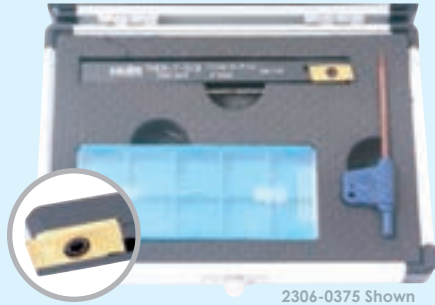

2306-0375 Shown

Limited Supply!



2306-0500 Shown



2306-0625 Shown

Item#	Toolholder Designation	Shank Dia (In)	OAL (In)	Use Insert	Screw	Tox Wrench	Price (F)
2306-0375	THE-7-3/8-R	3/8	4.5	GIE-7-SG-	M3x8mm	T10	45.38
2306-0500	THE-7-1/2-R	1/2	4.5	GIE-7-SG-	M3x8mm	T10	49.14
2306-0625	THE-75/8-R	5/8	5.0	GIE-7-SG-	M3x8mm	T10	60.50



2306-2000 Shown INSERTS NOT INCLUDED

MINI-SYSTEM INTERNAL GROOVING & CUT-OFF HOLDERS

- Right hand shank.
- Insert not included.
- Set Includes: 1pc- Internal Holder, 1pc-T10 Wrench, 1pc-Aluminum Case.
- Accepts NIKCOLE style inserts.
- For use with .019 to .125" thin inserts.
- Ideal for internal grooving, threading, cut-off, turning & copying under .125" width.

RIGHT HAND HOLDER ONLY ACCEPT RIGHT HAND INSERTS

*Limited Supply

Item#	Toolholder Designation	Shank Dia (In)	OAL (In)	Use Insert	Screw	Tox Wrench	Price (F)
2306-1750	THI-7-3/4-R	3/4	5.6	GIE-7-SG-	M3x8mm	T10	56.71
2306-2000*	THI-7-1-R	1	6.0	GIE-7-SG-	M3x8mm	T10	64.27

MINI-SYSTEM STANDARD CARBIDE GROOVING, CUT-OFF INSERTS-GRADE C6-PV

- Grade C6-PV-Coated grade recommended for machining steels, cutting off and grooving at higher speeds.
- Tolerance: Width: +.0009"/-.0000"
- Fits NIKCOLE style mini groove RH tool holders.

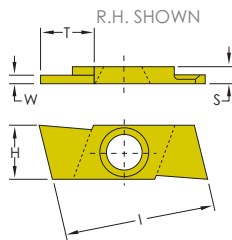

Item#	Insert #	Hand	Depth of Cut	Width of Cut	Price (E)
6061-0300	GIE-7-SG-05	R	.100" (2.54mm)	.019" (0.5mm)	39.22
6061-0301	GIE-7-SG-07	R	.100" (2.54mm)	.027" (0.7mm)	39.22
6061-0302	GIE-7-SG-08	R	.100" (2.54mm)	.031" (0.8mm)	39.22
6061-0303	GIE-7-SG-09	R	.100" (2.54mm)	.035" (0.9mm)	39.22
6061-0304	GIE-7-SG-1.1	R	.235" (6.0mm)	.043" (1.1mm)	39.22
6061-0305	GIE-7-SG-1.3	R	.235" (6.0mm)	.051" (1.3mm)	39.22
6061-0306	GIE-7-SG-1.6	R	.235" (6.0mm)	.063" (1.6mm)	39.22
6061-0307	GIE-7-SG-1.85	R	.235" (6.0mm)	.073" (1.85mm)	39.22
6061-0311	GIE-7-SG-07	L	.100" (2.54mm)	.027" (0.7mm)	39.22
6061-0312	GIE-7-SG-08	L	.100" (2.54mm)	.031" (0.8mm)	39.22
6061-0313	GIE-7-SG-09	L	.100" (2.54mm)	.035" (0.9mm)	39.22
6061-0314	GIE-7-SG-1.1	L	.235" (6.0mm)	.043" (1.1mm)	39.22
6061-0315	GIE-7-SG-1.3	L	.235" (6.0mm)	.051" (1.3mm)	39.22
6061-0316	GIE-7-SG-1.6	L	.235" (6.0mm)	.063" (1.6mm)	39.22
6061-0317	GIE-7-SG-1.85	L	.235" (6.0mm)	.073" (1.85mm)	39.22

TKEH EXTERNAL PARTING, GROOVING & TURNING TOOLHOLDERS

- Right hand.
- Tool holder design provides precision clamping & insert indexing accuracy.
- Ideal for external grooving, turning, part-off, relieving & profile machining.

Item#	Toolholder Designation	h=h1	b	F	L	L1	T	Dmax.	Use Insert	Screw	Key	Price (F)
2306-2375	TKEHR06-16C	3/8	3/8	3/8	5"	0.79	0.32	0.630	TKF16R	M4x9	T15	67.54
2306-2500	TKEHR08-16D	1/2	1/2	1/2	6"	-	0.32	0.630	TKF16R	M4x9	T15	71.42
2306-2625	TKEHR10-16D	5/8	5/8	5/8	6"	-	0.32	0.630	TKF16R	M4x9	T15	82.32

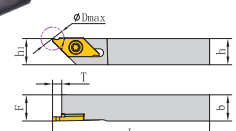

TKEH INSERTS: Grade WM125-Right Hand-AITin Coated

Item#	Insert	H	T	d	(mm) W	R	Ø	DMax	Price (F)
6061-1016	TKF16R100-S	9.5	4	5	1.0	0.05	0°	16	21.53
6061-1020	TKF16R150-S	9.5	4	5	1.5	0.05	0°	16	21.53
6061-1024	TKF16R200-S	9.5	4	5	2.0	0.05	0°	16	21.53

Limited Supply!



CUTTING & CARBIDE TOOLS

INDEXABLE PARTING & GROOVING TOOLS

MGEHR EXTERNAL PARTING GROOVING & TURNING TOOLHOLDERS

- Right hand.
- Tool holder design provides precision clamping & insert indexing accuracy.
- Ideal for external grooving, turning, part-off, relieving & profile machining.

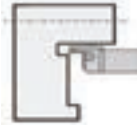

Item#	Toolholder Designation	Insert Width	Max. Cutting Depth	Shank Height	Shank Width	OAL	Use Insert	Screw	Hex Key	Price (F)
2207-0375	MGEHR06-2	0.079"	1/2"	3/8"	3/8"	3"	MGMN200	GB70-85-M4X12	S3	43.22
2207-0500	MGEHR08-2A	0.079"	1/2"	1/2"	1/2"	4"	MGMN200	GB70-85-M4X12	S3	43.22
2207-0625	MGEHR10-2B	0.079"	1/2"	5/8"	5/8"	4.5"	MGMN200	GB70-85-M5X14	S4	54.14
2207-0750	MGEHR12-2C	0.079"	1/2"	3/4"	3/4"	5"	MGMN200	GB70-85-M5X14	S4	54.14
2207-1000	MGEHR16-2D	0.079"	1/2"	1"	1"	6"	MGMN200	GB70-85-M6X20	S5	58.80

MGIV INTERNAL PARTING GROOVING & TURNING TOOLHOLDERS

- Right hand.
- Tool holder design provides precision clamping & insert indexing accuracy.
- Ideal for internal grooving, turning & profile machining.



Item#	Toolholder Designation	Insert Width W	Max. Cutting Depth T	Shank Dia. d	F	OAL L	Use Insert	Screw	Hex Key	Price (F)
2208-0625	S10K-MGIVR/L2	0.079"	0.197"	5/8"	1/2"	5"	MGMN200	GB70-85-M4X12	S3	69.72
2208-0750	S12M-MGIVR/L2	0.079"	0.197"	3/4"	5/8"	6"	MGMN200	GB70-85-M5X14	S4	82.92
2208-1000	S16R-MGIVR/L2	0.079"	0.197"	1"	3/4"	8"	MGMN200	GB70-85-M5X14	S4	98.50

EXTERNAL & INTERNAL GROOVING TOOL SETS

- Right hand.
- Suitable for varied external & internal grooving.
- Carbide inserts are included for semi-finishing/roughing machining.

Set Includes:

- 1-External tool holder (MGEHR)
- 1-Internal tool holder (S-MGIVR)
- 10 - TiN coated inserts
- 2 - Hex key
- 1 - Aluminium fitted case

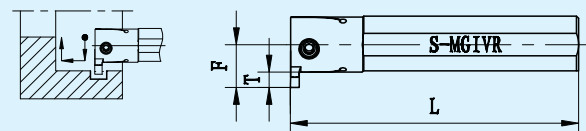
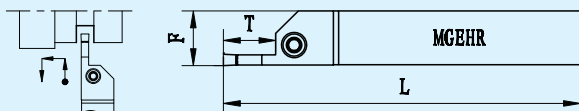
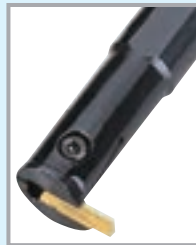

Dimensions

Item#	Shank Size	Holder Style	F	T	L	Screw	Hex Key	Insert Used	Price (E)
2208-0003	5/8"	MGEHR10-2B	0.64"	0.57"	4"	GB70-85-M4X10	S3	MGMN200	152.88
		S10K-MGIVR2	0.488"	0.2"	5"				
2208-0006	3/4"	MGEHR12-3C	0.803"	0.71"	5"	GB70-85-M4X12	S3	MGMN300	174.61
		S12M-MGIVR-3	0.614"	0.236"	6"				
2208-0009	1"	MGEHR16-4D	1"	0.71"	6"	GB70-85-M5X16	S4	MGMN400	194.85
		S16R-MGIVR4	0.744"	0.236"	8"				

MGMN INDEXABLE CUT-OFF AND GROOVING BLADES

- Right hand cutting.
- Double end.
- Use MGMN Inserts.

Limited Supply!



INSERT IS NOT INCLUDED

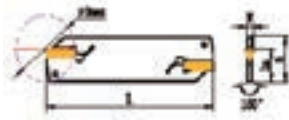

Item#	Width W	Dmax.	(Inch) h	h1	OAL L	Use Insert	Key	Price (F)
2209-0020	0.079	1.10	1.06	0.79	4.33	MGMN200	KD4	52.15
2209-0025	0.098	1.26	1.06	0.79	4.33	MGMN250	KD4	52.15
2209-0030	0.118	1.42	1.06	0.79	4.33	MGMN300	KD4	52.15
2209-0040	0.157	1.42	1.06	0.79	4.33	MGMN400	KD4	52.15
2209-0060	0.079	1.10	1.26	0.94	5.91	MGMN200	KD5	55.30
2209-0065	0.098	1.26	1.26	0.94	5.91	MGMN250	KD5	55.30
2209-0070	0.118	1.42	1.26	0.94	5.91	MGMN300	KD5	55.30
2209-0080	0.157	1.42	1.26	0.94	5.91	MGMN400	KD5	55.30

MGMN-G GROOVING CARBIDE INSERTS

MGMN-G

- Specially designed chip breaker allows narrower chips to promote better chip flow.
- Specifically designed for grooving applications.



10 PC PER PACKAGE

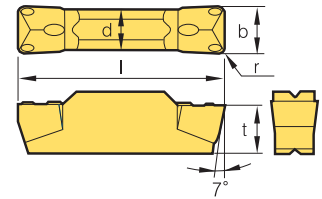

Item#	Insert No.	Cutting Width b	OAL L	(Inch) d	Cutting Edge Height t	r	Grade	Price (E)
6024-3021	MGMN-150-G	.059	.63	.047	.138	.006	BPS253-CVD	8.67
6024-3022	MGMN-200-G	.079	.63	.063	.138	1/128	BPS253-CVD	5.67
6024-3051	MGMN-200-G	.079	.63	.063	.138	1/128	BPG20B-PVD	5.67

MGMN-M GROOVING CARBIDE INSERTS

MGMN-M

- Specially designed chip breaker allows as smoother chip flow versus conventional flat top geometries through the use of a central chip breaker.
- Specially placed convex dots assists with chip control in external machining, for a smoother chip flow.
- Chip breaker designed for turning, grooving & parting applications.



10 PC PER PACKAGE

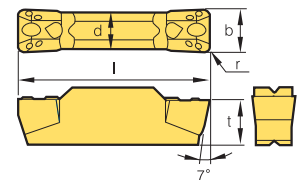

Item#	Insert No.	Cutting Width	OAL L	(Inch) d	Cutting Edge Height t	r	Grade	Price (F)
6024-3002	MGMN-250-M	.098	.73	.079	.152	1/128	BPS253-CVD	5.78
6024-3003	MGMN-300-M	.118	.83	.093	.189	1/64	BPS253-CVD	5.78
6024-3004	MGMN-400-M	.157	.83	.130	.189	1/64	BPS253-CVD	6.53
6024-3052	MGMN-250-M	.098	.73	.079	.152	1/128	BPG20B-PVD	5.78
6024-3053	MGMN-300-M	.118	.83	.093	.189	1/64	BPG20B-PVD	5.78

MRMN-M GROOVING CARBIDE INSERTS

MRMN-M

- Full radius geometry for applications that require profiling
- Available for relief machining

*Limited Supply



10 PC PER PACKAGE

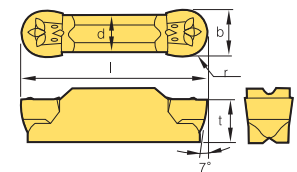

Item#	Insert No.	Cutting Width b	OAL L	(Inch) d	Cutting Edge Height t	r	PVD Grade	Price (E)
6024-3031	MRMN-200-M	.079	.630	.059	.079	3/64	BPS253	6.57
6024-3032	MRMN-300-M	.118	.827	.093	.118	1/16	BPS253	6.57
6024-3033	MRMN-400-M	.157	.827	.130	.157	5/64	BPS253	6.86
6024-3034*	MRMN-500-M	.197	1.024	.161	.197	3/32	BPS253	10.44
6024-3035	MRMN-600-M	.236	1.024	.197	.236	1/8	BPS253	11.66

GRADE COMPARISON

BPG253-CVD

CVD coated universal grade is suitable for steel and cast steel continuous cutting and interrupted cutting, finishing to roughing. With a wide range of application, Stainless steel continuous cutting and interrupted cutting.

BPG20B-PVD

PVD coated micro-grain carbide to use for a variety of stainless steel finishing at medium to low cutting speed. Excellent edge strength and high surface quality, provide the perfect ride cutting. High thermal shock resistance. Suitable for light interrupted cuts.

INDEXABLE CUT-OFF TOOLS

INDEXABLE CUT-OFF & GROOVING TOOLS & KITS - For Larger Tool Posts

All Tools Are Interchangeable With ISCAR & Other Fine Brands !

ISCAR TYPE CUT-OFF TOOLS

Kit includes:
Tool block, blade(s), C6 carbide inserts,
insert holder, Allen wrench and case.

16 PC 3/4" SHANK KIT
Item#3900-5361 Shown

Tool Block

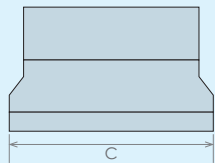
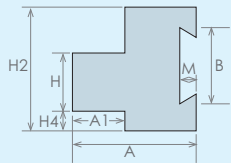

Cut-off Blade

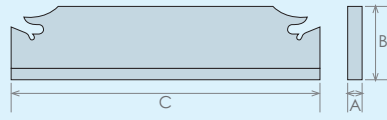

Item#	No. of Pieces	Tool Block Dimension (Inch)									Cut-off Blade Dimension (Inch)			Blade Fil	Insert	Price (E)
		H	A1	A	B	H2	H4	M	C	C	B					
3900-5359	15	SLTBN16-5	5/8"	0.750	1.50	1.02	1.71	.52	.21	3.47 (1 pc)	NCIH26-3	4-5/16	1-1/32 (1 pc)	26-3	GTN-3 (10 pcs)	119.88
3900-5361	16	SLTBN19-5	3/4"	0.750	1.45	1.02	1.70	.39	.21	3.47 (1 pc)	NCIH26-3	4-5/16	1-1/32 (1 pc)	26-3	GTN-3 (5 pcs)	159.96
											NCIH26-4	4-5/16	1-1/32 (1 pc)	26-4	GTN-4 (5 pcs)	
3900-5364	22	SLTBN25-6	1"	0.750	1.50	1.26	1.97	.30	.21	4.33 (1 pc)	NCIH32-3	5-7/8	1-1/4 (2 pcs)	32-3	GTN-3 (4 pcs)	274.93
											NCIH32-4	5-7/8	1-1/4 (2 pcs)	32-4	GTN-4 (4 pcs)	
											NCIH32-5	5-7/8	1-1/4 (2 pcs)	32-5	GTN-5 (4 pcs)	

INDEXABLE CUT-OFF & GROOVING TOOL KITS - For Smaller Tool Posts

All Tools Are Interchangeable With ISCAR & Other Fine Brands !

ISCAR TYPE CUT-OFF TOOLS

15 PC KIT INCLUDES:

- 1 - Tool Block (SLTBN)
- 1 - Cut-off Blade (NCIH)
- 10 - C-6 GTN Inserts (TiN Coated)
- 2 - Allen Wrench
- 1 - Fitted case

Tool Block

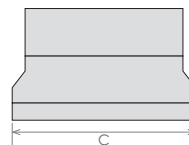
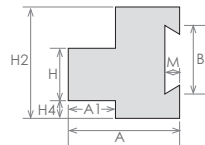

Cut-off Blade

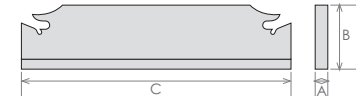

Item#		Tool Block Dimension (Inch)									Cut-off Blade Dimension (Inch)			Blade Fil	Insert (10pc)	Price (E)
		H	A1	A	B	H2	H4	M	C	C	B					
3900-5366	SLTBN0250-2	1/4	0.472	0.984	0.787	1.161	0.498	0.118	2.2	NCIH19-2	3.38	3/4	19-2	GTN-2	112.16	
3900-5367	SLTBN0312-2	5/16	0.472	0.984	0.787	1.161	0.435	0.118	2.2	NCIH19-2	3.38	3/4	19-2	GTN-2	109.67	
3900-5368	SLTBN0375-2	3/8	0.472	0.984	0.787	1.161	0.373	0.118	2.2	NCIH19-2	3.38	3/4	19-2	GTN-2	109.67	
3900-5369	SLTBN0500-2	1/2	0.472	0.984	0.787	1.161	0.248	0.118	2.2	NCIH19-2	3.38	3/4	19-2	GTN-2	104.75	

CARBIDE CUT-OFF INSERTS

GRADE
C-2 FOR CAST IRON AND GENERAL PURPOSE
C-6 FOR ALL STEEL AND GENERAL PURPOSE
TIN (C-6) FOR INCREASED PRODUCTIVITY

*Limited Supply

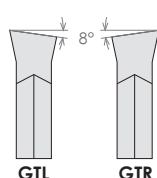
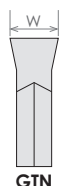

Insert Style	Insert Size (W) (In)	C-2 Item#	Price (F)	C-6 Item#	Price (F)	TiN Coated(C-6) Item#	Price (F)
GTN-2	.087	3900-5802	4.62	3900-5309	5.17	6024-2002	5.45
GTN-2.4	.094	6024-0002*	4.62	-----	-----	-----	-----
GTN-3	.120	-----	-----	6024-1003	5.00	6024-2003	7.23
GTN-4	.160	6024-0004	5.75	6024-1004	5.35	6024-2004	7.23
GTN-4.8	.187	6024-0008*	4.28	6024-1008*	12.43	6024-2008*	7.23
GTN-5	.200	6024-0005	5.51	6024-1005	5.51	6024-2005	7.65
GTR-4.8	.187	6024-1014*	5.51	6024-1015*	7.16	-----	-----
GTL-4.8	.187	6024-1024*	5.51	-----	-----	6024-2034*	7.23



INDEXABLE CUT-OFF BLADES

All Tools Are Interchangeable With ISCAR & Other Fine Brands !
ISCAR TYPE CUT-OFF TOOLS

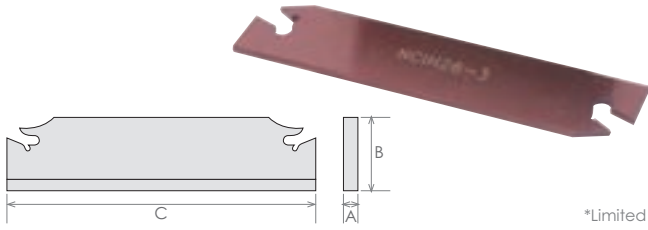

*Limited Supply

Item#	Insert Width A	Blade Style	C	B	Price (E)
3900-5313	.087&.094"	19-2	3.38	3/4	35.69
3900-5311	.087&.094"	26-2	4-5/16"	1-1/32	38.38
3900-5312	.120"	26-3	4-5/16"	1-1/32	38.38
3900-5314	.160"	26-4	4-5/16"	1-1/32	39.04
3900-5316	.187&.200"	26-5	4-5/16"	1-1/32	39.04
3900-5315*	.250"	26-6	4-5/16"	1.1/32	39.04
3900-5317	.120"	32-3	5-7/8"	1-1/4	42.71
3900-5318	.160"	32-4	5-7/8"	1-1/4	42.71
3900-5319	.187&.200"	32-5	5-7/8"	1-1/4	47.58
3900-5325	.250"	32-6	5-7/8"	1-1/4	47.58

INDEXABLE CUT-OFF TOOL BLOCKS

All Tools Are Interchangeable With ISCAR & Other Fine Brands !

ISCAR TYPE CUT-OFF TOOLS

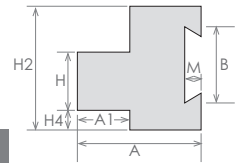

Clamping Height H (in)	Blade Height B (in)	Clamping Depth A1 (in)	Block Width A (in)	Block Height H2 (in)	Shoulder Depth H4 (in)	Blade Pocket M (in)	Block Length C (in)	Blade Fit	Item#	Price (E)
0.625	0.75	0.625	1.19	1.30	.16	.12	3.00	19-2	3900-5353	46.15
0.625	1.02	0.750	1.50	1.71	.52	.21	3.47	26-2, 26-3, 26-4, 26-5, 26-6	3900-5354	46.15
0.750	1.02	0.750	1.50	1.71	.39	.21	3.47	26-2, 26-3, 26-4, 26-5, 26-6	3900-5351	46.15
0.750	1.25	0.750	1.50	1.97	.55	.21	3.97	32-3, 32-4, 32-5, 32-6	3900-5352	52.40
1.000	1.25	0.750	1.50	1.97	.30	.21	4.33	32-3, 32-4, 32-5, 32-6	3900-5355	54.28
1.250	1.25	0.750	1.81	1.92	--	.21	4.33	32-3, 32-4, 32-5, 32-6	3900-5356	60.33

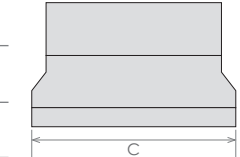

SGTH STYLE CUT-OFF TOOL HOLDERS

Accepts GTN Carbide Inserts



INSERT IS NOT INCLUDED

*Limited Supply

Holder Style	Shank Size	Insert Width	Use Insert	Max. Work Diameter	RH Item#	Price (F)
9.5-2	3/8 x 3/8"	.087 & .094"	GTN-2	1.10"	2203-0952	35.52
12.7-2	1/2 x 3/8"	.087 & .094"	GTN-2	1.18"	2203-1272	39.53
12.7-3	1/2 x 3/8"	.120"	GTN-3	1.26"	2203-1273*	38.10
16-4	5/8 x 1/2"	.160"	GTN-4	1.34"	2203-1640*	31.75
19-4	3/4 x 1/2"	.160"	GTN-4	1.38"	2203-1940	39.68
19-5	3/4 x 1/2"	.187 & .200"	GTN-5	1.38"	2203-1950	45.73

SLTH STYLE CUT-OFF TOOL HOLDERS

Accepts GTN Carbide Inserts



*Limited Supply

Holder Style	Shank Size	Insert Width	Use Insert	Max. Work Diameter	RH Item#	Price (F)
9.5-2	3/8 x 3/8"	.087 & .094"	GTN-2	1-7/64"	2201-0952	32.28
12.7-2	1/2 x 25/64"	.087 & .094"	GTN-2	1-11/64"	2201-1272	42.19
12.7-3	1/2 x 25/64"	.120"	GTN-3	1-17/64"	2201-1273*	37.03
16-3	5/8 x 15/32"	.120"	GTN-3	1-17/64"	2201-1630*	31.26
16-4	5/8 x 15/32"	.160"	GTN-4	1-21/64"	2201-1640*	36.89
19-4	3/4 x 15/32"	.160"	GTN-4	1-17/32"	2201-1940*	48.99

GROOVING INTEGRAL SHANK TOOL HOLDERS

Accepts GTN Carbide Inserts



INSERT IS NOT INCLUDED

Holder Style	Shank Size	Use Insert	Max. Depth	RH Item#	Price (F)
08R-25	1/2 x 1/2"	GTN-3	.79"	2204-0825	41.93
10R-25	5/8 x 5/8"	GTN-3	.79"	2204-1025	37.52
12R-30	3/4 x 3/4"	GTN-3	.79"	2204-1230	65.26
12R-40	3/4 x 3/4"	GTN-4	.79"	2204-1240	65.26
16R-30	1 x 1"	GTN-4	.98"	2204-1630	65.26

CUT-OFF TOOLS

RETROFIT GTN CUT-OFF AND GROOVING BLADES



INSERT IS NOT INCLUDED
See page 139 for inserts

*Limited Supply

- Used on Aloris and DORAIN Type Quick-Change Tool Holders
- High performance rates. No more re-grinding. Insert indexability.
- Also can use GTL, GTR inserts.

Item#	Fits Holder	HSS Blade Reference	Blade Height	Cutting Width	Overall Length	Use Insert	Price (F)
3900-5971	AXA-7	P2	1/2	.087 & .093"	4-11/32	GTN/R/L 2	49.40
3900-5973	BXA-7	P3N	11/16	.087 & .093"	4-11/32	GTN/R/L 2	57.72
3900-5975	BXA-7	P3, T3	11/16	.120"	4-11/32	GTN/R/L 3	59.40
3900-5977	CXA-7	P3W	3/4	.120"	4-11/32	GTN/R/L 3	65.26
3900-5979	CA-7	P5X	7/8	.120"	5-29/32	GTN/R/L 3	66.97
3900-5981*	CA-7	P5N	7/8	.160"	5-29/32	GTN/R/L 4	64.28

P-TYPE CUT-OFF BLADES

- Parallel style blades have continuous width of cutting edge throughout length of blade.
- Used with Aloris, DORIAN & KDK type quick-change tool holders.

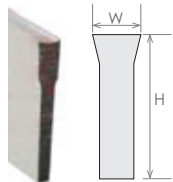
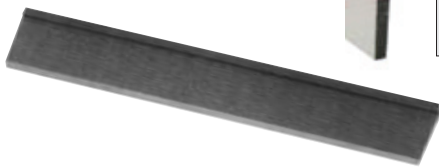

- **M2 HIGH SPEED STEEL** A fine general purpose ground tool bits show exceptional result on mild steel, alloys and tool steels. This tool bit makes a superior finishing tool.
- **COBALT M42 (8%)** Superior types of high speed steel which will work better where high heat is present. Used for heavy cuts in hard materials.

Parallel Style	Width W (in)	Height H (in)	Length (in)	HSS Item#	Price (F)	8% Cobalt Item#	Price (F)
P1N	.04	1/2	3-1/2	2000-6008	9.69	2000-7008	14.46
P1	1/16	1/2	4-1/2	2000-6010	10.56	2000-7010	17.11
P2	3/32	1/2	4-1/2	2000-6020	9.85	2000-7020	13.94
P2N	5/64	1/2	4-1/2	2000-6022	10.64	-----	-----
P3S	1/8	1/2	4-1/2	2000-6025	12.99	2000-7025	15.40
P3N	3/32	11/16	5	2000-6030	14.10	2000-7030	16.69
P3	1/8	11/16	5	2000-6035	14.46	2000-7035	20.83
P3W	1/8	3/4	5	2000-6050	14.43	2000-7050	19.68
P4	5/32	11/16	5	2000-6055	17.76	2000-7055	27.89
P5	3/16	7/8	6	2000-6064	28.32	-----	-----
P5X	1/8	7/8	6	2000-6065	23.79	2000-7065	31.32
P5N	5/32	7/8	6	2000-6066*	17.47	2000-7066	34.30
P6	1/4	7/8	6	2000-6070	31.54	-----	-----

*Limited Supply

CUT-OFF BLADES, BEVELED

- **M2 HIGH SPEED STEEL** A fine general purpose ground tool bits show exceptional result on mild steel, alloys and tool steels. This tool bit makes a superior finishing tool.
- **COBALT M35 (5%)** Superior types of high speed steel which will work better where high heat is present. Used for heavy cuts in hard materials.

- Used with Aloris, DORIAN & KDK type quick-change tool holders.
- 10° double beveled.



(Inch) Size (TxWxL)	HSS Item#	Price (F)	5% COBALT Item#	Price (F)
3/32 x 1/2 x 4-1/2	2000-1002	6.83	2000-1102	10.16
3/32 x 5/8 x 5	2000-1003	8.79	2000-1106	11.78
1/8 x 1/2 x 4-1/2	2000-1000	7.43	2000-1110	10.58
1/8 x 3/4 x 5	2000-1004	9.88	2000-1114	14.09
1/8 x 7/8 x 6	2000-1005	13.57	2000-1118	19.68



CUT-OFF TOOL HOLDERS For Use With Cut-Off Blades

- Machined to precise tolerances and carefully heat-treated, these cut-off tool holders support the blade over a wide area, reducing the chance of blade breakage. Blade can be adjusted to any desired clearance for greater versatility, and it is beveled on both sides and held at an angle, providing necessary side clearance and top rake for a clean smooth cut. These holders DO NOT hold parallel type cut-off blades.



Blade NOT Included

*Limited Supply

Holder Size	Cut-Off Blade Size	Item#	Price (F) Ea.
5/16 x 3/4 x 4-1/2"	3/32 x 1/2"	2205-0312*	29.87
3/8 x 7/8 x 5"	3/32 x 5/8"	2205-0375	38.83
1/2 x 1-1/8 x 6"	1/8 x 3/4"	2205-0500	43.84
5/8 x 1-3/8 x 7"	1/8 x 7/8"	2205-0625	48.40
3/4 x 1-5/8 x 8"	3/16 x 1"	2205-0750*	48.39

INDEXABLE TURNING & BORING TOOLS

7PC MINI TOOL HOLDER SET-Accept CCMT Inserts

- Use CCMT inserts
- Complete with fitted case.

*Limited Supply

Item#	Turn Shank	Bore Shank	Insert	Screw	Price (F)
2003-0250*	1/4"	5/16"	CCMT21.5	M2.5x6	133.98
2003-0375	3/8"	3/8"	CCMT21.5	M2.5x6	153.74
2003-0500	1/2"	1/2"	CCMT21.5	M2.5x6	163.87
2003-0625*	5/8"	5/8"	CCMT32.5	M4x10	205.54

- **Set includes:**
 - 6-Turning Holder (SCMCN, SDCDN, SCLCR, SCLCL, SCKCR & SCBCR)
 - 1-Boring Holder (SCLCR)
 - 1-T8 Torx Wrench

Inserts see page 172



5PC INDEXABLE CARBIDE TURNING TOOL SETS

5PC SETS

Item#	Square Shank	Insert I.C.	Set No.	Torx Wr.	Price (F)
2003-0001	1/4"	7/32"	ST-4	T6	43.92
2003-0002	3/8"	1/4"	ST-6	T8	46.11
2003-0003	1/2"	3/8"	ST-8	T15	50.22
2003-0004	5/8"	3/8"	ST-10	T15	52.41
2003-0005	3/4"	3/8"	ST-12	T15	62.82
2003-0006	1"	1/2"	ST-16	T20	96.93

5pc set includes:

- One of each - AR, AL, BR, BL & E Holder
- C-5 Inserts, TCMT style
- 5pc spare screws
- 2 Torx wrench
- Fitted case.

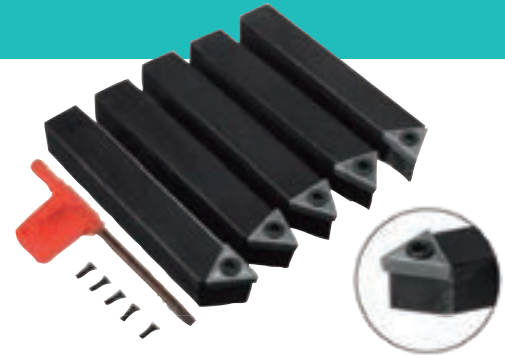

INDIVIDUAL (Insert & Torx Wrench Included)

Type	1/4 Shank 7/32 IC Insert		3/8 Shank, 1/4 IC Insert		1/2 Shank, 3/8 IC Insert		5/8 Shank, 3/8 IC Insert		3/4 Shank, 3/8 IC Insert		1 Shank, 1/2 IC Insert	
	Item#	Price (F)	Item#	Price (F)	Item#	Price (F)	Item#	Price (F)	Item#	Price (F)	Item#	Price (F)
AR	2003-0101	9.49	2003-0111	10.86	2003-0121	12.85	2003-0131	13.88	2003-0141	15.92	2003-0151	20.92
AL	2003-0102	9.49	2003-0112	10.86	2003-0122	12.85	2003-0132	13.88	2003-0142	15.92	2003-0152	20.92
BR	2003-0103	9.49	2003-0113	10.86	2003-0123	12.85	2003-0133	13.88	2003-0143	15.92	2003-0153	20.92
BL	2003-0104	9.49	2003-0114	10.86	2003-0124	12.85	2003-0134	13.88	2003-0144	15.92	2003-0154	20.92
E	2003-0105	9.49	2003-0115	10.86	2003-0125	12.85	2003-0135	13.88	2003-0145	15.92	2003-0155	20.92

REPLACEMENT INSERTS

Fit Shank	Insert I.C.	Insert No.	TIN (C-6)	
			Item#	Price (F)
1/4"	7/32	TCMT090204	6004-9020	6.00
3/8"	1/4	TCMT110204	6004-9021	5.76
1/2, 5/8 & 3/4"	3/8	TCMT16T304	6004-9031	5.83
1"	1/2	TCMT220408	6004-6142	10.55



10 PC PER PACKAGE

REPLACEMENT SCREWS

Screw	For Set	Item#	Price (F)
M2.5	1/4, 3/8"	2003-0012	1.68
M4	1/2, 5/8 & 3/4"	2100-0074	5.39
M5	1"	2100-0076	5.28

See page 185 for more inserts

5PC INDEXABLE TURNING & BORING TOOL SETS-Accepts TCMT Inserts

- Use TCMT inserts
- Set comes with 4 turning tools, 1 boring tool, inserts & torx wrenches
- Complete with fitted aluminium case.



Inserts see page 185

*Limited Supply

Item #	Shank	Style in Set	Insert	Screw	Price (E)
2003-0031	5/16	STACR05-1.8	TCMT090204	M2.2x6	81.07
		STDCR05-1.8	TCMT090204	M2.2x6	
		STNCR05-1.8	TCMT090204	M2.2x6	
		STECN05-1.8	TCMT090204	M2.2x6	
		S05H-STFCR1.8	TCMT090204	M2.2x6	
2003-0032	3/8	STACR06-2	TCMT110204	M2.5x6	85.03
		STDCR06-2	TCMT110204	M2.5x6	
		STNCR06-2	TCMT110204	M2.5x6	
		STECN06-2	TCMT110204	M2.5x6	
		S06M-STFCR2	TCMT110204	M2.5x6	
2003-0033	1/2	STACR08-2	TCMT110204	M2.5x6	88.20
		STDCR08-2	TCMT110204	M2.5x6	
		STNCR08-2	TCMT110204	M2.5x6	
		STECN08-2	TCMT110204	M2.5x6	
		S08Q-STFCR2	TCMT110204	M2.5x6	
2003-0034*	5/8	STACR10-3	TCMT16T304	M4x10	125.88
		STDCR10-3	TCMT16T304	M4x10	
		STNCR10-3	TCMT16T304	M4x10	
		STECN10-3	TCMT16T304	M4x10	
		S10R-STFCR3	TCMT16T304	M4x8	
2003-0035*	3/4	STACR12-3	TCMT16T304	M4x10	150.79
		STDCR12-3	TCMT16T304	M4x10	
		STNCR12-3	TCMT16T304	M4x10	
		STECN12-3	TCMT16T304	M4x10	
		S12S-STFCR3	TCMT16T304	M4x10	

INDEXABLE TURNING & BORING TOOLS

6PC 1/2" SHANK INDEXABLE TURNING TOOL SETS

- Made of 40Cr alloy steel.
- Screw down style.
- Tin coated inserts included.
- Complete with fitted aluminium case.

6 PC SET
3/8" SHANK
2003-0701
\$114.46
(F)



6 PC SET
1/2" SHANK
2003-0705
\$129.24
(F)

Holder Style	Shank	Holder	OAL	Use Insert	Use Torx Wr.	Use Screw
SVJCR06-2	3/8"	Turning	3	VCMT21.51	T-8	M2.5x7
SVJCL06-2	3/8"	Turning	3	VCMT21.51	T-8	M2.5x7
SCLCR06-2	3/8"	Boring	3	CCMT21.51	T-8	M2.5x7
SSDCN06-2J	3/8"	Turning	3	SCMT21.51	T-8	M2.5x7
S06H-SCLCR2	3/8"	Boring	4	CCMT21.51	T-8	M2.5x6
(1/2x1/2 with 3/8"Hole)	3/8"	Adapter	2.75	--	--	---

Shank No.	Center Height	Shank Dia.	OAL	Insert	Screw	Torx Wr.
SVJCR08-2A	1/2"	-	4"	VCMT21.51	M2.5x7	T8
SVJCL08-2A	1/2"	-	4"	VCMT21.51	M2.5x7	T8
SCLCR08-2A	1/2"	-	4"	CCMT21.51	M2.5x7	T8
SSDCN08-2A	1/2"	-	4"	SCMT21.51	M2.5x7	T8
S06K-SCLCR2	-	1/2"	5"	CCMT21.51	M2.5x6	T8
ADAPTER 1/2" I.D.	-	-	-	-	-	-

INSERTS - Replacement

Item #	Size	Price (F)
6053-0111	CCMT21.51	7.11
6004-3030	SCMT21.51	5.38
6005-3403	VCMT21.51	5.83

SCREWS - Replacement

Item #	Size	Price (F)
2100-0070	M2.5x6	3.63
2100-0066	M2.5x7	3.63

TORX WRENCH - Replacement

Item #	Size	Price (F)
2100-0092	T8	3.10

INDEXABLE CUT OFF AND TURNING TOOL SETS

- Carbide inserts and Allen wrench included.
- Multi-purpose Indexable tools
- Complete with fitted case.

7PC SET INCLUDES:

- (A) Right Hand 90°
- (B) Right Hand 93°
- (C) Right Hand 95°
- (D) Right Hand 62.5°
- (E) Left Hand 95°
- (F) External Threading
- (G) Cut-off tool

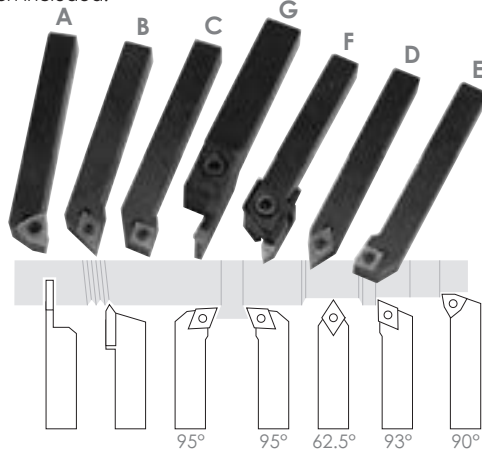

7PC SETS

Item#	Shank	Price (F)
2002-0010	1/4"	137.76
2002-0012	3/8"	137.76
2002-0013	1/2"	150.94
2002-0014	5/8"	210.99
2002-0015	3/4"	228.58

C-6 REPLACEMENT INSERTS

Item#	Style	For Shank	Insert No.	Price (F)
6003-2021	C, E	1/4, 3/8 & 1/2"	CCMT060204	6.00
2002-0104	B, D	1/4, 3/8 & 1/2"	DCMT070202	6.72
2002-0105	F	1/4, 3/8 & 1/2"	JCL-15-120	3.65
2002-0106	G	All	JCQ3	3.65
2002-0107	A	1/4, 3/8 & 1/2"	WCMX50308	6.00
6003-5031	C, E	5/8 & 3/4"	CCMT09T304	8.25
6004-0031	B, D	5/8 & 3/4"	DCMT11T304	9.18
2002-0127	F	5/8 & 3/4"	JCL20-120A	5.14
2002-0128	A	5/8 & 3/4"	WCMT06T308	6.06
2002-0126	A	5/8 & 3/4"	WCMT06T304	6.79
2002-0130	A	1/4, 3/8 & 1/2"	WCMT050308	5.57

REPLACEMENT SCREWS (7pc Set)

Item#	For Shank	Price (F)
2002-0122	1/4, 3/8 & 1/2"	22.28
2002-0142	5/8, & 3/4"	17.26

9PC INDEXABLE TURNING & BORING TOOL SETS

- Complete with fitted aluminium case.
- Set includes:** Turning Holders, Boring Tools Holders, Inserts & Torx Wrenches

Item #	Shank	Style in Set	Insert	Screw	Price (E)
2002-0212	3/8	SSSCR3/8-3	SCMT09T3	M4x10	253.09
		SSBCR3/8-3	SCMT09T3	M4x10	
		SWGCR3/8-3	WCMT06T3	M4x10	
		S-SSSCR5/16H3	SCMT060204	M2.5x6	
		S-SSKCR5/16H3	SCMT060204	M2.5x6	
		S-SWUCR5/16"H3	WCMT06T3	M4x8	
		SER0375F11	11ERA60	M2.5x6	
		S3/8H-S1R11	11IRA60	M2.5x6	
		MGEHR3/8-02	MGMN200	GB70-85/M4x12	
		2002-0213	1/2	SSSCR1/2-3	
SSBCR1/2-3	SCMT09T3			M4x10	
SWGCR1/2-3	WCMT06T3			M4x10	
S-SSSCR3/8J3	SCMT09T3			M4x10	
S-SSKCR3/8J3	SCMT09T3			M4x10	
S-SWUCR3/8J3	WCMT06T3			M4x10	
SER0500H11	11ERA60			M2.5x6	
S1/2J-STR11	11IRA60			M2.5x6	
MGEHR1/2-02	MGMN200			GB70-85/M4x12	

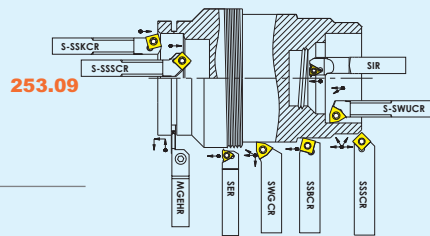
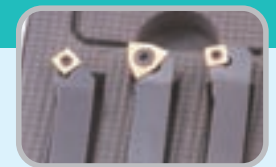
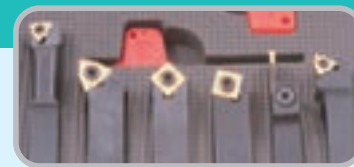

INSERTS - Replacement

Item#	Insert No.	Coated Grade	Price (F)
6004-3031	SCMT09T304	XAB749	8.70
2002-0128	WCMT06T308	TIN	6.06
6004-3030	SCMT060204	TIN	5.38

Pro-Series 7PC INDEXABLE TURNING TOOL SETS



- Complete with fitted aluminium case.
- **Set includes:** Turning Holders, Inserts & Torx Wrenches

Item #	Shank	Style in Set	Insert	Screw	Price (E)
2002-0112	3/8	MGEHR3/8-02 (CUT OFF BLADE)	MGMN200	GB70-85/M4x12	161.74
		SER3/8-11	11ERA60	M2.5x6	
		SWGCR3/8-05	WCMT050308	M3x8	
		SCLCR3/8-2	CCMT060204	M2.5x6	
		SCLCL3/8-2	CCMT060204	M2.5x6	
		SDNCR3/8-2	DCMT070204	M2.5x6	
2002-0113	1/2	MGEHR1/2-02 (CUT OFF BLADE)	MGMN200	GB70-85/M4x12	173.16
		SER1/2-11	11ERA60	M2.5x6	
		SWGCR1/2-05	WCMT050308	M3x8	
		SCLCR1/2-2	CCMT060204	M2.5x6	
		SCLCL1/2-2	CCMT060204	M2.5x6	
		SDNCR1/2-2	DCMT070204	M2.5x6	
2002-0114	5/8	MGEHR5/8-03 (CUT OFF BLADE)	MGMN300	GB70-85/M5x14	202.40
		SER5/8-16	16ERA60	M3.5x11	
		SWGCR5/8-06	WCMT06T308	M4x8	
		SCLCR5/8-3	CCMT09T304	M4x10	
		SCLCL5/8-3	CCMT09T304	M4x10	
		SDNCR5/8-3	DCMT11T304	M4x10	
2002-0115	3/4	MGEHR3/4-03 (CUT OFF BLADE)	MGMN300	GB70-85/M5x14	242.37
		SER3/4-16	16ERA60	M3.5x11	
		SWGCR3/4-06	WCMT06T308	M4x10	
		SCLCR3/4-3	CCMT09T304	M4x10	
		SCLCL3/4-3	CCMT09T304	M4x10	
		SDNCR3/4-3	DCMT11T304	M4x10	

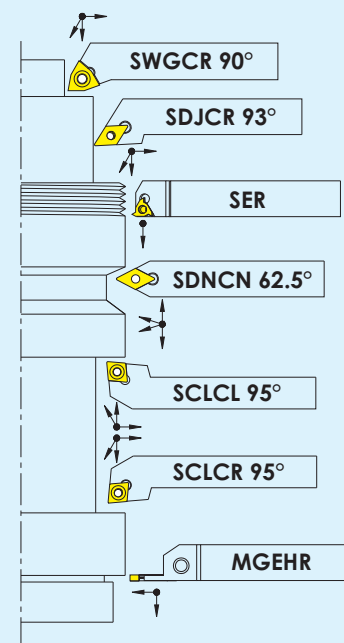

REPLACEMENT CARBIDE INSERTS

- For 7pc Indexable Tools Sets.
- Coated.



Item#	Insert No.	Coated Grade	Price (F)
6024-3022	MGMN-200-G	BPS253CVD	5.67
6007-0004	11ERA60	TiN	10.20
6015-0005	WCMT050308	XAF799	8.73
6003-2021	CCMT060204	TiN	6.00
6004-0021	DCMT070204	XAB749	6.72
6024-3003	MGMN300-M	BPS-253CVD	5.78
6007-0012	16ERA60	TiN	10.20
6015-0008	WCMT06T304	XAF799	10.41
6003-2032	CCMT09T304	TiN	7.18
6004-0032	DCMT11T304	XAB749	9.18

REPLACEMENT CARBIDE INSERTS-TCMT

- For 5pc Indexable Tools Sets.
- Tin Coated.

Item#	Insert No.	Grade	Price (F)
6004-9020	TCMT090204	TiN	6.00
6004-9021	TCMT110204	TiN	5.76
6004-9031	TCMT16T304	TiN	5.83



SCREWS



Item#	Style	Price (F)
2100-0065	M2.2x6	3.63
2100-0070	M2.5x6	3.63
2100-0003	M3x8	4.41
2100-0083	M3.5x11	3.97
2100-0069	M4x8	4.40
2100-0074	M4x10	5.39
2100-0082	GB70-85 M4x12	3.97
2100-0087	GB70-85 M5x14	4.36

INDEXABLE BORING BARS

INDEXABLE BORING BAR IDENTIFICATION SYSTEM

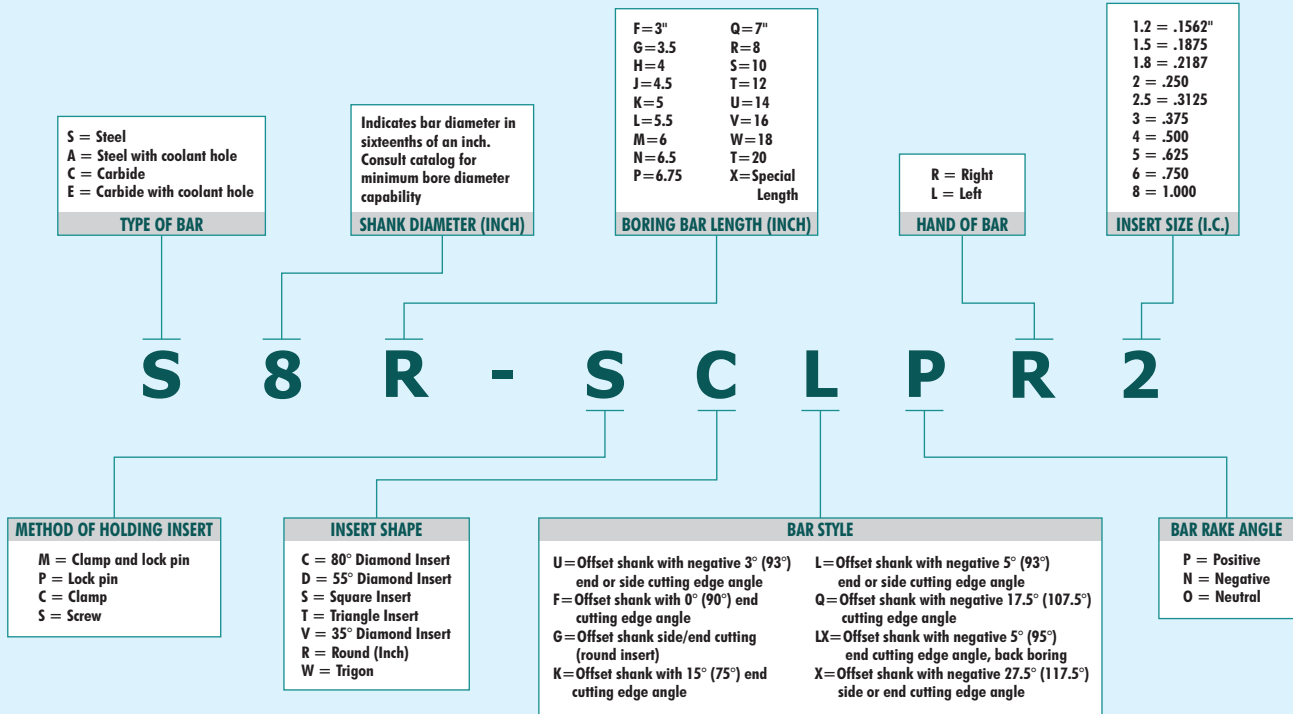

SCLCR INDEXABLE BORING BARS & SETS

SCLCR

- Utilize CCMT 80° diamond inserts.
- 7° Relief angle.
- Negative 5° Lead angle for boring.
- 3° Side & end cutting edge angle.
- Torx wrench included.
- CCMT insert included.

Application:

- Profiling bars for semi-finishing and finishing operations

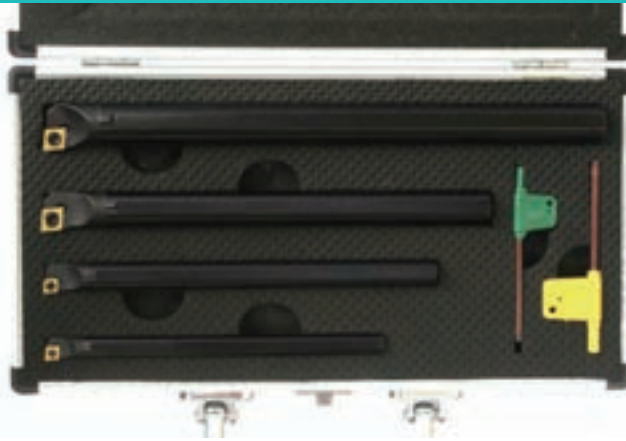

3 PC SET
 Style A, B, C
1001-0020
\$120³⁸
 (F)
 5/16, 3/8 & 1/2

3 PC SET
 Style C, E, F
1001-0021
\$136¹⁵
 (F)
 1/2, 5/8 & 3/4"

4 PC SET
 Style B, D, E, F
1001-0054
\$199⁴³
 (F)
 3/8, 1/2, 5/8 & 3/4"

5 PC SET
 Style A, B, C, E, F
1001-0023
\$223⁷⁸
 (F)
 5/16, 3/8, 1/2, 5/8 & 3/4"

INDIVIDUALS

Item#	SET/Style	Dia. x OAL	Min. Bore	Insert	Screw	Torx Wrench	Price (F)
1001-0025	A	5/16 x 4"	.415"	CCMT-21.5	M2.5x5	T-8	39.06
1001-0026	B	3/8 x 6"	.480"	CCMT-21.5	M2.5x6	T-8	39.06
1001-0024	C	1/2 x 8"	.600"	CCMT-21.5	M2.5x6	T-8	41.04
1001-0027	D	1/2 x 7"	.600"	CCMT-32.5	M4x8	T-15	41.85
1001-0028	E	5/8 x 8"	.770"	CCMT-32.5	M4x8	T-15	50.34
1001-0029	F	3/4 x 10"	.945"	CCMT-32.5	M4x10	T-15	56.00
1001-0030	G	1 x 12"	1.250"	CCMT-32.5	M4x10	T-15	64.29
1001-0031	H	1 x 12"	1.250"	CCMT-432	M5x12	T-20	77.35

See page 172 for carbide inserts. Spare parts shown on pages 165-166.

INSERTS - Replacement

Item #	Size	Price (F)
6053-0111	CCMT21.51	7.11
6053-0112	CCMT21.52	7.11
6053-0222	CCMT32.52	8.25
6053-0432	CCMT432	10.98

SCREWS - Replacement

Item #	Size	Price (F)
2100-0070	M2.5x6	3.63
2100-0069	M4x8	4.40
2100-0074	M4x10	5.39
2100-0076	M5x12	5.28

TORX WRENCHES - Replacement

Item #	Size	Price (F)
2100-0092	T8	3.10
2100-0095	T15	3.10
2100-0096	T20	3.10

SCLCR COOLANT-THRU INDEXABLE BORING BARS & SETS

SCLCR

- Utilizes CCMT 80° diamond inserts.
- 7° Relief angle.
- Negative 5° Lead angle for boring.
- Torx wrench included.
- CCMT insert included.

4pc Set Includes:

- (4) Indexable Boring Bars.
- (2) Torx wrenches.
- (14) CCMT inserts



**COOLANT-THRU
4PC SET
1001-0699**
\$239.50
(F)
5/16, 3/8, 1/2 & 5/8"

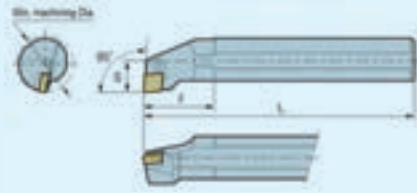

Application:

- Profiling bars for semi-finishing and finishing operations
- The coolant hole allows the cutting edge to cool and removes chips.

See pages 171-172 for carbide inserts.
Spare parts shown on pages 165-166.

INDIVIDUAL

Dimension Style	(Inch) Dia. x OAL	Min. Bore	Insert	Screw	Torx Wrench	Item#	Price (F)
A05H-SCLCR2	5/16 x 4	0.415"	CCMT-21.5	M2.5x5	T-8	1001-0312	52.58
A06J-SCLCR2	3/8 x 4-1/2	0.48"	CCMT-21.5	M2.5x6	T-8	1001-0375	49.82
A08K-SCLCR2	1/2 x 5	0.6"	CCMT-21.5	M2.5x6	T-8	1001-0500	49.82
A10M-SCLCR2	5/8 x 6	0.77"	CCMT-21.5	M2.5x6	T-8	1001-0625	58.80

SCLPR INDEXABLE BORING BARS-SCREW ON STYLE Negative 5-Degree Lead Angle for Boring and Profiling, 11° Relief

SCLPR

- Use for boring & facing

Boring Bar Style	Shank	(Inch) Min. Bore	OAL	Insert Style	Screw	Torx Wrench	Item#	Price (F)
6M-2	0.375	0.480	6	CPMT-21.51	M2.5x6	T-8	1009-0375	33.94
8R-2	0.500	0.600	8	CPMT-21.51	M2.5x6	T-8	1009-0500	33.94
10S-3	0.625	0.770	10	CPMT-32.52	M4x8	T-15	1009-0625	41.93
12S-3	0.750	.0945	10	CPMT-32.52	M4x10	T-15	1009-0750	43.92
16T-4	1.000	1.250	12	CPMT-432	M5x12	T-20	1009-1000	55.49
18S-09	18mm	22mm	250mm	CPMT09T304	M4x9	T15	1009-1018*	42.71

See page 175 for carbide inserts. Spare parts shown on pages 165-166.



INSERT NOT INCLUDED

*Limited Supply

SDJCR INDEXABLE BORING BARS - SCREW ON Negative 3-Degree Lead Angle, 7° Relief

SDJCR-RH

- Use DCMT 55° rhombic positive inserts

Application: Profiling and copying boring bar for semi finishing

Boring Bar Style	Shank	(Inch) Min. Bore	OAL	Use Insert	Screw	Torx Wrench	Item#	Price (F)
8-2	1/2	.780	8	DCMT-21.52	M2.5x6	T-8	1010-0500	31.94
10-2	5/8	.840	10	DCMT-21.52	M2.5x6	T-8	1010-0625	45.42
12-3	3/4	1.125	10	DCMT-32.52	M4x10	T-15	1010-0750	46.73
16-3	1	1.500	12	DCMT-32.52	M4x10	T-15	1010-1000	53.09

See pages 175-176 for carbide inserts. Spare parts shown on pages 165-166.



INSERT NOT INCLUDED

SDUCR INDEXABLE BORING BARS - SCREW ON STYLE Negative 3-Degree Lead Angle for Boring and Profiling, 7° Relief Offset shank with negative 3° (93°) end or side cutting edge

SDUCR

- Use DCMT 55° rhombic positive inserts

Application: Profiling and copying boring bar for semi finishing

Boring Bar Style	Shank	(Inch) Min. Bore	OAL	Use Insert	Screw	Torx Wrench	Item#	Price (F)
6-2	0.375	0.520	6	DCMT-21.51	M2.5x6	T-8	1003-2375	36.31
8-2	0.500	0.640	6	DCMT-21.51	M2.5x6	T-8	1003-2500	41.93
10-2	0.625	0.770	8	DCMT-21.51	M2.5x6	T-8	1003-2625	44.30
12-3	0.750	0.945	10	DCMT-32.52	M4x10	T-15	1003-2750	46.73

See page ??? for carbide inserts. Spare parts shown on pages ???.



INSERT NOT INCLUDED

INDEXABLE BORING BARS

STFCR INDEXABLE BORING BARS-SCREW ON STYLE 0-Degree Lead Angle for Boring and Profiling, 7° Relief

STFCR

- Use TCGT or TCMT inserts

Boring Bar Style	Shank	Min. Bore	OAL	Use Insert	Screw	Torx Wrench	Item#	Price (F)
6-2	0.375"	0.480"	6"	TCMT-21.51	M2.5x6	T-8	1004-2375	33.28
8-2	0.500"	0.600"	8"	TCMT-21.51	M2.5x6	T-8	1004-2500	31.94
10-2	0.625"	0.770"	10"	TCMT-21.51	M2.5x6	T-8	1004-2625	41.76
12-3	0.750"	0.945"	10"	TCMT-32.52	M4x10	T-15	1004-2750	43.48
18S-16	18mm	22mm	250mm	TCMT16T304	M4x8	T-15	1004-3018*	34.17



INSERT NOT INCLUDED

See page 185 for carbide inserts. Spare parts shown on pages 165-166.

*Limited Supply

MTFNR3 INDEXABLE BORING BARS - CLAMP ON - COOLANT-THRU 0-Degree Lead Angle

MTFNR3

Uses TNMG, TNMM, TNMA Inserts

Limited Supply!

INSERT NOT INCLUDED



Boring Bar Style	Shank	(Inch) Min. Bore	OAL	Use Insert	Shim	Lock Pin	Clamp	Hex Wrench	Clamp Screw	Item#	Price (F)
A20T	1-1/4	1.57	14	TN...-33.	T1603B	NL-0414	CL-6	2.5mm	XNS-0520	1007-1250	90.10
A24T	1-1/2	2.00	14	TN...-33.	T1603B	NL-0414	CL-6	2.5mm	XNS-0520	1007-1500	130.45

See pages 186-188 for carbide inserts. Spare parts shown on pages 165-166.

STFPR INDEXABLE BORING BARS - SCREW ON 0-Degree Lead Angle For Boring and Facing, 11° Relief

STFPR

- Use TPMT inserts

Boring Bar Style	Shank	Min. Bore	OAL	Use Insert	Screw	Torx Wrench	Item#	Price (F)
6M-2	3/8"	0.480"	6"	TPMT-21.51	M2.5x6	T-8	1021-0375	31.09
8R-2	1/2"	0.600"	8"	TPMT-21.51	M2.5x6	T-8	1021-0500	31.09
10S-2	5/8"	0.770"	10"	TPMT-21.51	M2.5x6	T-8	1021-0625	37.94
12S-3	3/4"	0.945"	10"	TPMT-32.52	M4x10	T-15	1021-0750	49.92
16T-3	1"	1.250"	12"	TPMT-32.52	M4x10	T-15	1021-1000	64.49
18S-16	18mm	22	250mm	TPMT16T304	M4x8	T-15	1021-1018*	47.11



INSERT NOT INCLUDED

See page 189 for carbide inserts. Spare parts shown on pages 165-166.

*Limited Supply

CTFPR INDEXABLE BORING BARS - CLAMP ON 0-Degree Lead Angle For Boring and Facing

MCTFPR

- Use TPG inserts

Boring Bar Style	Shank	Min. Bore	OAL	Use Insert	Clamp	Clamp Screw	Hex Wrench	Item#	Price (F)
12S-3	3/4"	0.945"	10"	TPG-32.	CTFPN-5	CTFP-M5	3.0mm	1023-0750	59.88
16T-3	1"	1.250"	12"	TPG-32.	CTFPN-5	CTFP-M5	3.0mm	1023-1000	59.88
20U-3	1-1/4"	1.570"	14"	TPG-32.	CL-20	XNS-620	3.0mm	1023-1250	57.13
24U-4	1-1/2"	2.000"	14"	TPG-43.	CL-20	XNS-620	3.0mm	1023-1500	78.38



Limited Supply!

INSERT NOT INCLUDED

See page 189 for carbide inserts. Spare parts shown on pages 165-166.

MCLNR INDEXABLE BORING BARS - CLAMP ON Negative 5-Degree Lead Angle

MCLNR

- Use CNMG inserts

INSERT NOT INCLUDED

Boring Bar Style	Shank	Min. Bore	OAL	Use Insert	Lock Pin	Shim	Clamp	Clamp Screw	Hex Wrench	Item#	Price (F)
20T-4	1-1/4"	1.57"	12"	CNMG-432	NL-0617	C1203B	CL-6	XNS0520	2.5mm	1024-1250	101.83
24U-4	1-1/2"	2.00"	14"	CNMG-432	NL-0617	C1203B	CL-6	XNS0520	2.5mm	1024-1500	135.74
28U-4	1-3/4"	2.03"	14"	CNMG-432	NL-0617	C1203B	CL-6	XNS0520	2.5mm	1024-1750*	173.71



See pages 173-175 for carbide inserts. Spare parts shown on pages 165-166.

*Limited Supply

HARLINGEN® MCLNR INDEXABLE BORING BARS -CLAMP ON - COOLANT THRU

MCLNR

- 5-degree lead angle for turning, profiling or facing.
- Uses CNMG432 insert.
- Coolant through.

INSERT NOT INCLUDED

Up to 30% Higher Productivity & Profitability!

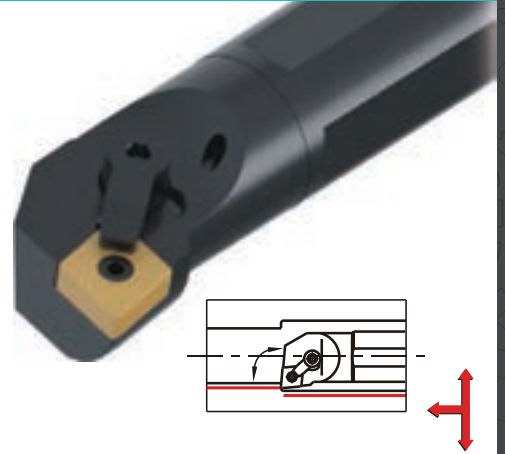
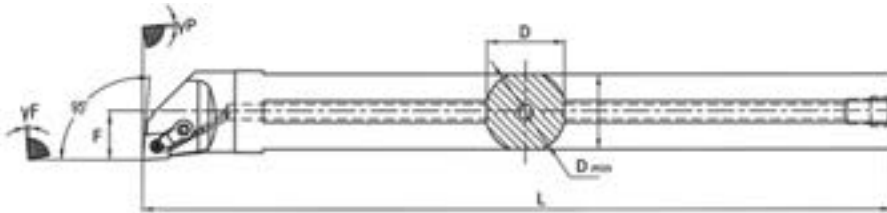

Item#	Tool Holder Style	Dimensions						Shim	Lock Pin	Clamp	Clamp Screw	Hex Wrench	Price (F)
		F	P	D	D min	L	F						
9710-0008	A24-4	-12°	-5°	1.453"	1.5"	14"	89/100"	ICSN-433	NL-46	CK-20	SCT-20	S3/32,S1/8	151.11

See pages 173-175 for carbide inserts. Spare parts shown on pages 165-166.

MTFNR INDEXABLE BORING BARS - CLAMP ON 0-Degree Lead Angle

MTFNR

Uses TNMG, TNMM, TNMA Inserts

Limited Supply!

INSERT NOT INCLUDED



Boring Bar Style	Shank	(Inch) Min. Bore	OAL	Lock Pin	Hex Wrench	Shim	Use Insert	Hex Wrench	Clamp	Clamp Screw	Item#	Price (F)
12-3	3/4	0.945	10	NL-0410	2mm	----	TN..-33.	2.5mm	CL-6	XNS0520	1025-0750	80.04
20-3	1-1/4	1.570	14	NL-0410	2mm	T-1603B	TN..-33.	2.5mm	CL-6	XNS0520	1025-1250	56.68
24-3	1-1/2	2.00	14	NL-0410	2mm	T-1603B	TN..-33.	2.5mm	CL-6	XNS0520	1025-1501	99.01
24-4	1-1/2	2.00	14	NL-0617	2.5mm	T-2203B	TN..-43.	4mm	CL-12	XNS0829	1025-1500	91.67

See pages 186-188 for carbide inserts. Spare parts shown on pages 165-166.

MVUR INDEXABLE BORING BARS - CLAMP ON Negative 3-Degree Lead Angle

MVUR

Uses VNMG, VNMM, VNMA,VBMT Inserts

INSERT NOT INCLUDED

Boring Bar Style	Shank	Min. Bore	OAL	Use Insert	Clamp	Lock Pin	Clamp Screw	Hex Wrench	Item#	Price (F)
16T-3	1"	1.30"	12"	VBMT-332	CL-20	NL-0410	XNS0620	2mmx3mm	1026-1000	71.86

See page 191 for carbide inserts. Spare parts shown on pages 165-166.



MWLNR INDEXABLE BORING BARS - CLAMP ON Negative 5-Degree Lead Angle, 0° Relief

MWLNR

Uses WNMG, WNMA Inserts

INSERT NOT INCLUDED

Boring Bar Style	Shank	Min. Bore	OAL	Hex Wrench	Use Insert	Lock Pin	Shim	Clamp	Clamp Screw	Hex Wrench	Item#	Price (F)
12S-3	3/4"	0.945"	10"	2mm	WNMG-332	NL-0410	---	CL-6	XNS0520	2.5mm	1028-0750	60.86
16T-4	1"	1.250"	12"	2mm	WNMG-432	NL-0611	---	CL-20	XNS0620	2.5mm	1028-1001	72.82
20U-3	1-1/4"	1.540"	14"	2mm	WNMG-332	NL-0414	W0603B	CL-6	XNS0520	2.5mm	1028-1250	74.90
20U-4	1-1/4"	1.57"	14"	2mm	WNMG-432	NL-0617	W0803B	CL-20	XNS0620	2.5mm	1028-1251	110.84

See pages 194-195 for carbide inserts. Spare parts shown on pages 165-166.

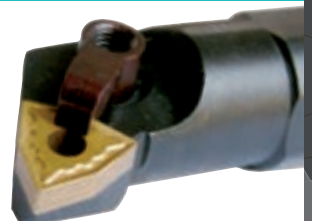

INDEXABLE BORING BARS

TBB INDEXABLE BORING BARS

Use TPGH, TPMM, TPGW Inserts, 11° Relief



Limited Supply!

INSERT NOT INCLUDED

See page 191 for carbide inserts. Spare parts shown on pages 165-166.

Boring Bar Style	Shank	(Inch) Min. Bore	OAL	Use Insert	Angle Enter	Screw	Torx Wrench	Item#	Price (F)
S6-2	1/2	.430	5	TPG.-22.	91°	M2.5x6	T-8	1029-0500	18.85
S8	1/2	.700	6	TPG.-32.	91°	M4x8	T-15	1029-0503	26.13
L8	1/2	.700	6	TPG.-32.	85°	M4x8	T-15	1029-0504	26.13
N8	1/2	.700	6	TPG.-32.	95°	M4x8	T-15	1029-0505	26.13
L10	5/8	.710	7	TPG.-32.	85°	M4x8	T-15	1029-0626	34.22
N10	5/8	.710	7	TPG.-32.	95°	M4x8	T-15	1029-0627	28.03
S12-3	3/4	.845	10	TPG.-32.	91°	M4x10	T-15	1029-0750	37.92

TPBN INDEXABLE BORING BAR SETS

Use TPGW Inserts

Features:

- Small hole capacity to a minimum of .430"
- Insert pocket has been scientifically designed to eliminate vibration and maximize the depth of cut.
- Bars made of heat treated, precision ground alloy steel.
- Clearance angle of the insert, in relation to cutting edge, gives best micro finish.
- The positive insert with advanced chip breaker design allows for heavier cuts.



1001-0727 Shown

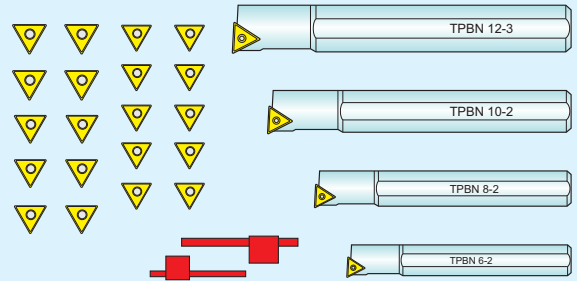
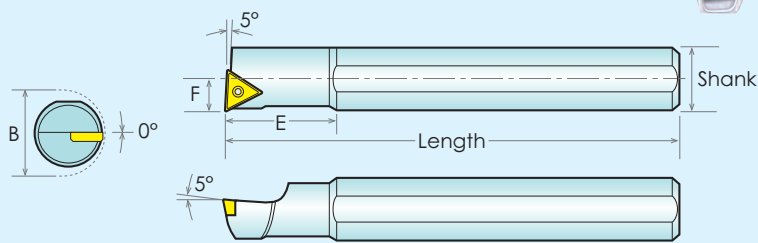

27 PC SET
1001-0727
\$551²⁶
 (F)
 Includes: 8pc of each Boring Bars, Carbide Inserts, & Torx Screws, 3pc Torx Keys, Fitted Case

27pc Set Includes:

Boring Bar Style	Shank	(Inch) Min. Bore	OAL	Screw	Torx Wr.	Use Insert
6-2	1/2	.430	5	M2.5x6	T8	TPGW-21.5
8-2	1/2	.590	6	M2.5x6	T8	TPGW-21.5
10-2	5/8	.682	8	M2.5x6	T8	TPGW-21.5
12-3	3/4	.845	10	M4x8	T15	TPGW-32.
16-3	1	1.115	12	M4x10	T15	TPGW-32.
20-3	1-1/4	1.370	12	M4x10	T15	TPGW-32.
20-4	1-1/4	1.370	12	M5x12	T20	TPGW-43.
24-4	1-1/2	1.680	12	M5x12	T20	TPGW-43.

31 PC SET
1001-0731
\$281⁵²
 (F)
 Includes: 4 pc Boring Bars, 20 pc Carbide Inserts, & 4 pc Torx Screws, 2 pc Torx Keys, Fitted Case

31pc Set Includes:

Boring Bar Style	Shank	Min. Bore	OAL	Screw	Torx Wr.	Use Insert
6-2	1/2"	.430"	5"	M2.5x6	T8	TPGW-21.5
8-2	1/2"	.590"	6"	M2.5x6	T8	TPGW-21.5
10-2	5/8"	.682"	8"	M2.5x6	T8	TPGW-21.5
12-3	3/4"	.845"	10"	M4x8	T15	TPGW-32.

See page 190 for carbide inserts. Spare parts shown on pages 165-166.

BBN/BBS INDEXABLE BORING BARS

Use TPGH, TPMM, TPGW Inserts • Positive Rake • 11° Relief

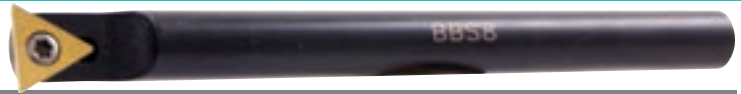

Boring Bar Style	Shank	Min. Bore	OAL	Use Insert	Lead Angle	Screw	Torx Wrench	Item#	Price (F)
S8	1/2"	.700"	6"	TP..-32.	-1	M4x10	T-15	1030-0500	31.15
N8	1/2"	.700"	6"	TP..-32.	-5	M4x10	T-15	1030-0502*	31.94
S10	5/8"	.710"	7"	TP..-32.	-1	M4x10	T-15	1030-0625*	41.32
N10	5/8"	.710"	7"	TP..-32.	-5	M4x10	T-15	1030-0627	38.74
N12-3	3/4"	.845"	10"	TP..-32.	-5	M4x10	T-15	1030-0750	46.73
S12-3	3/4"	.845"	10"	TP..-32.	-1	M4x10	T-15	1030-0751*	30.04

See page 191 for carbide inserts. Spare parts shown on pages 165-166.

*Limited Supply

MINI INDEXABLE BORING BARS

Use CCMT Inserts, 7° Relief



- Screw down style

See page 171 for carbide inserts. Spare parts shown on pages 165-166

Boring Bar Style	Shank	Min. Bore	OAL	Neck Dia.	Neck Length	Use Insert	Screw	Torx	Item#	Price (F)
S05 SCLCR06	5/16"	.415"	4.00"	.236"	.985"	CCMT-21.5	M2.5x5	T-8	1031-0312	34.61
S06 SCLCR06	3/8"	.472"	4.33"	.315"	1.26"	CCMT-21.5	M2.5x6	T-8	1031-0375	34.61
S08 SCLCR06	1/2"	.552"	5.00"	.393"	1.50"	CCMT-21.5	M2.5x6	T-8	1031-0500	34.61
S10 SCLCR06	5/8"	.708"	5.90"	.472"	1.97"	CCMT-21.5	M2.5x6	T-8	1031-0625	34.61

INDIVIDUAL ROUND SHANK INDEXABLE BORING BARS

Use TCMT Inserts • Positive Rake 90° Lead, 7° Relief

- Negative 3° lead angle.
- Uses TCMT insert.
- Screw down style.
- Includes TiN coated insert.



Item#	Shank Dia.	Length	Bore Depth	Min. Bore	Insert	Screw	Torx Wr.	Price (F)	Item#	Shank Dia.	Length	Bore Depth	Min. Bore	Insert	Screw	Torx Wr.	Price (F)
1001-0741	1/2	2-3/4	1-1/4	7/16	TCMT21.51	M2.5x5	T-8	28.54	1001-0761*	5/8	4-5/8	2-7/8	9/16	TCMT221	M2.5x6	T-8	27.69
1001-0743	1/2	3-5/8	2-1/8	7/16	TCMT21.51	M2.5x5		25.56	1001-0771	3/4	3-3/8	1-3/8	7/16	TCMT21.51	M2.5x5		37.01
1001-0745	1/2	3	1-1/2	1/2	TCMT21.51	M2.5x6		28.54	1001-0773	3/4	4-1/4	2-1/4	7/16	TCMT21.51	M2.5x5		37.01
1001-0747	1/2	4	2-1/2	1/2	TCMT21.51	M2.5x6		28.54	1001-0775	3/4	3-5/8	1-5/8	1/2	TCMT21.51	M2.5x6		37.01
1001-0751	5/8	3	1-1/4	7/16	TCMT21.51	M2.5x5		30.94	1001-0777	3/4	4-5/8	2-5/8	1/2	TCMT21.51	M2.5x6		37.01
1001-0753*	5/8	3-7/8	2-1/8	7/16	TCMT21.51	M2.5x5		27.69	1001-0779	3/4	3-7/8	1-7/8	9/16	TCMT221	M2.5x6		37.01
1001-0755*	5/8	3-1/4	1-1/2	1/2	TCMT21.51	M2.5x6		33.02	1001-0781	3/4	5	3	9/16	TCMT221	M2.5x6		37.01
1001-0757	5/8	4-1/4	2-1/2	1/2	TCMT21.51	M2.5x6		27.69	1001-0783*	3/4	4-1/4	2-1/4	11/16	TCMT221	M2.5x7		37.01
1001-0759	5/8	3-1/2	1-3/4	9/16	TCMT221	M2.5x6		27.69	1001-0785	3/4	5-1/2	3-1/2	11/16	TCMT221	M2.5x7		37.01

See page 185 for carbide inserts. Spare parts shown on pages 165-166.

*Limited Supply

7PC 18MM ROUND SHANK INDEXABLE BORING BAR SET

Use TCMT Inserts • Positive Rake 90° Lead, 7° Relief

- Negative 3° lead angle.
- TCMT21-5. insert fits all bars.
- Made of 40Cr alloy steel.
- Screw down style.
- Includes C-6 inserts.
- Furnished with fitted aluminium case.

Shank No.	Dc Min.	Shank dm	L	Lc	Insert	Screw	Torx Wr.
SBJ1810-40TC06	10	18	88	40	TCMT06T104L	M2x5	T6
SBJ1812-53TC09	12	18	100	53	TCMT090204L	M2.5x6	T8
SBJ1816-68TC09	16	18	113	68	TCMT090204L	M2.5x6	T8
SBJ1820-83TC11	20	18	123	83	TCMT110304L	M3x7	T10
SBJ1825-90TC11	25	18	130	90	TCMT110304L	M3x7	T10
SBJ1830-90TC11	30	18	130	90	TCMT110304L	M3x7	T10
SBJ18F-108TC11	110	18	108	-	TCMT110340L	M3x7	T10

See page 185 for carbide inserts. Spare parts shown on pages 165-166.



7PC SET
1001-0718
\$261⁴⁶
(F)

INDEXABLE BORING BARS

7PC 1/2" ROUND SHANK INDEXABLE BORING BAR SET Uses TCMT Inserts, 7° Relief

- Made of 40Cr steel.
- Use TC __ Style inserts.
- Screw down style.
- Includes inserts.
- Complete with fitted aluminum case.

7PC SET
1001-0705
\$20275
(F)

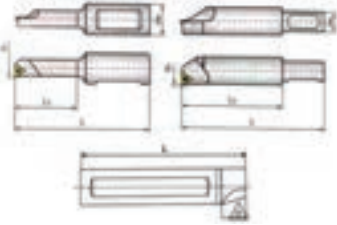

Shank dm	Min. Bore Dc.	Bore Depth Lc	OAL L	Use Insert	Use Torx Wr.	Use Screw	Bar Style Code
1/2"	5/16	1.25	2.75	TCMT06T-104L	T-6	M2x4	SBJ0805-1.25TC52
	3/8	1.57	3.00	TCMT06T-104L	T-6	M2x5	SBJ0806-1.57TC52
	1/2	2.09	3.42	TCMT090204L	T-8	M2.5x6	SBJ0808-2.09TC73
	5/8	2.68	3.94	TCMT090204L	T-8	M2.5x6	SBJ0810-2.68TC73
	3/4	3.25	4.53	TCMT110304L	T-10	M3x8	SBJ0812-3.25TC22
	1	3.54	4.80	TCMT110304L	T-10	M3x8	SBJ0816-3.54TC22
	3	-	2.75	TCMT110304L	T-10	M3x7	SBJ08F-2.75TC22

See page 185 for carbide inserts. Spare parts shown on pages 165-166.

4PC 1/2" ROUND SHANK INDEXABLE BORING BAR SET Use TCMT Inserts • Positive Rake 90° Lead, 7° Relief

- Negative 3° lead angle.
- TCMT21-5. insert fits all bars.
- Screw down style.
- Includes inserts.



4PC SET
1/2" SHANK
1001-0704
\$11779
(F)

Set	Shank	Min. Bore	(Inch) OAL	Bore Depth	Use Insert	Use Torx Wr.	Use Screw
4	1/2	7/16	2-3/4	1-1/4	TCMT21-51	T-8	M2.5x5
	1/2	7/16	3-5/8	2-1/8			M2.5x5
	1/2	1/2	3	1-1/2			M2.5x6
	1/2	1/2	4	2-1/2			M2.5x6

See page 185 for carbide inserts. Spare parts shown on pages 165-166.

6PC 5/8" ROUND SHANK INDEXABLE BORING BAR SET Use TCMT Inserts • Positive Rake 90° Lead, 7° Relief

- Negative 3° lead angle.
- TCMT21-5. insert fits all bars.
- Screw down style.
- Includes inserts.
- Includes fitted case.



6PC SET
5/8" SHANK
1001-0711
\$18924
(F)

Set	Shank	Min. Bore	(Inch) OAL	Bore Depth	Use Insert	Use Torx Wr.	Use Screw
6	5/8	7/16	3	1-1/4	TCMT21-51	T-8	M2.5x5
		7/16	3-7/8	2-1/8			M2.5x5
		1/2	3-1/4	1-1/2			M2.5x6
		1/2	4-1/4	2-1/2	M2.5x6		
		9/16	3-1/2	1-3/4	TCMT221		M2.5x6
		9/16	4-5/8	2-7/8			M2.5x6

See page 185 for carbide inserts. Spare parts shown on pages 165-166.

8PC 3/4" ROUND SHANK INDEXABLE BORING BAR SET Use TCMT Inserts • Positive Rake 90° Lead, 7° Relief

- Negative 3° lead angle.
- TCMT21-5. insert fits all bars.
- Screw down style.
- Includes inserts.
- Includes fitted case.

8PC SET
3/4" SHANK
1001-0708
\$29148
(F)



Set	Shank	Min. Bore	(Inch) OAL	Bore Depth	Use Insert	Use Torx Wr.	Use Screw
8	3/4	7/16	3-3/8	1-3/8	TCMT21-51	T-8	M2.5x5
		7/16	4-1/4	2-1/4			M2.5x5
		1/2	3-5/8	1-5/8			M2.5x6
		1/2	4-5/8	2-5/8			M2.5x6
		9/16	3-7/8	1-7/8	TCMT221		M2.5x6
		9/16	5	3			M2.5x6
		11/16	4-1/4	2-1/4			M2.5x7
		11/16	5-1/2	3-1/2			M2.5x7

See page 185 for carbide inserts. Spare parts shown on pages 165-166.

ADVANTAGES OF T-STYLE TOOL HOLDERS - RIGID CLAMP DESIGN

- New clamping mechanism allows clamping force to be applied not only downward but also pulling inward towards the tool body.
- Unique feature improves clamping rigidity and position accuracy which in turn will extend insert tooling life.
- Locating pin on the front of the clamp makes an arc contact with the inner wall of insert hole, resulting in an evenly distributed clamping force that is more secure and rigid.
- Locating lug on the back of the clamp matches with the slot on the tool body to guide the clamp to be seated repetitively which will improve the clamping accuracy.

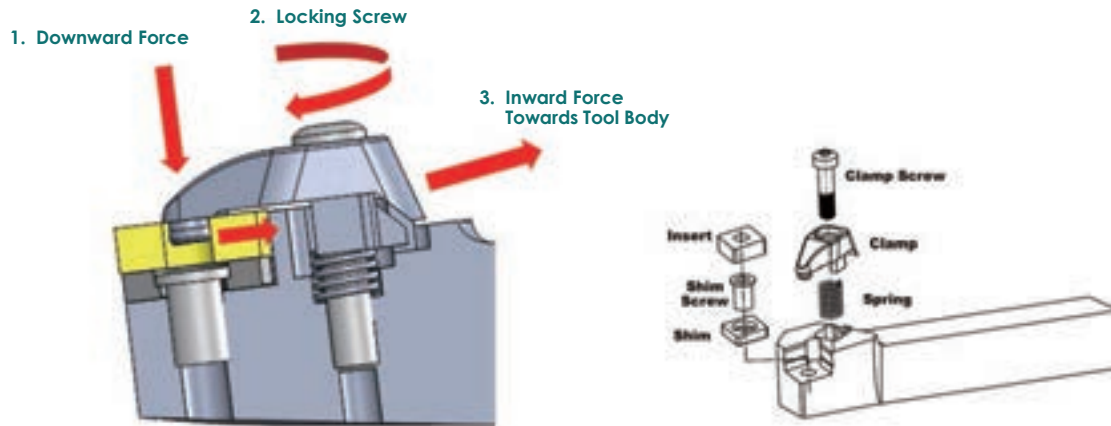

HARLINGEN® HIGH QUALITY INDEXABLE TURNING TOOL HOLDERS - ADVANTAGES

- Superior edge toughness.
- Excellent wear and depth-of-cut notch resistance.
- For use in all finishing, medium, and roughing applications.

• SURFACE FINISHING

Each tool holder is black oxidized. The ultra smooth surface is rust proof and extremely durable.

• 100% INSERT SEATING CONTROL

Using a .02mm feeler gage, each tool is qualified to assure the gap between the insert and pocket base is <0.02mm. We guarantee the Gap is <.02mm

Up to 30% Higher Productivity & Profitability!

• TOOL HOLDER HARDNESS HRC 45

High grade alloy steel provides outstanding strength and rigidity delivering higher productivity, stability, and longer tool life.

• CHAMFERS

All the chamfers are processed by CNC machines to ensure uniformity.

INSERT BASE, NOSE HEIGHT, EDGE TO TIP, LENGTH OF TOOL HOLDER.

Each dimension is 100% inspected by testing with specific inspection insert according to ISO standard.

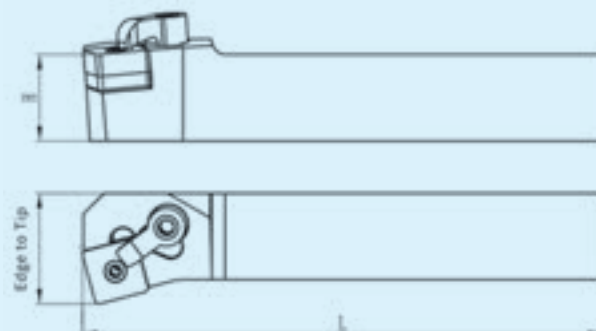

INDEXABLE TURNING TOOL HOLDERS

CTAPR TOP CLAMP STYLE TOOL HOLDERS 0° LEAD ANGLE • RIGHT HAND

CTAPR

- 11° Relief
- For turning and facing.

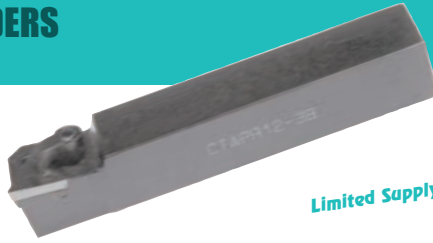
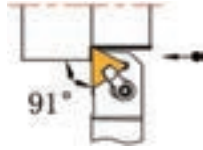

Limited Supply!

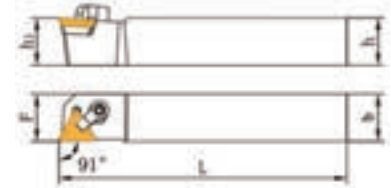

90° RIGHT HAND

See pages 165-166 for spare parts. Replacement inserts shown on page 189.

INSERTS NOT INCLUDED

Item#	Industry Ref. No.	Dimensions				Insert	Shim	Shim Screw	Clamp	Clamp Screw	Key	Price (F)
		h=h1	Shank Dia. b	Offset F	OAL L							
2016-2102	CTAPR10-2B	5/8"	5/8"	.63"	4-1/2"	TP...22-	T11D	M2.5x6	CL-6	XNS-0520	T8 S2.5	38.49
2016-2163	CTAPR16-3D	1"	1"	1.00"	6"	TP...32-	T16D	M3x8-D5	CL-6	XNS-0520	S2 S2.5	42.58

CTFPR TOP CLAMP STYLE TOOL HOLDERS 0° LEAD ANGLE • RIGHT HAND

CTFPR

- 11° Relief

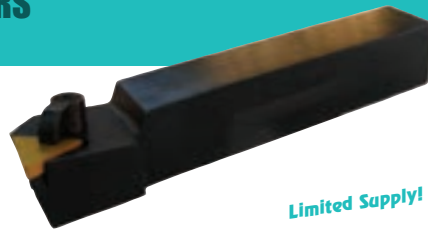
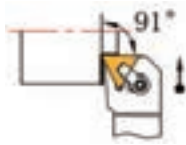

Limited Supply!

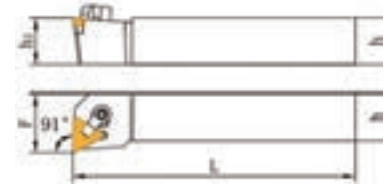

90° RIGHT HAND

INSERTS NOT INCLUDED

See pages 165-166 for spare parts. Replacement inserts shown on page 189.

Item#	Industry Ref. No.	Dimensions				Insert	Shim	Shim Screw	Clamp	Clamp Screw	Key	Price (F)
		h=h1	Shank Dia. b	Offset F	OAL L							
2031-0124	CTFPR12-3B	3/4"	3/4"	1.00"	4-1/2"	TP...32-	T16D	M3x8-D5	CL-6	XNS-0520	S2 S2.5	34.69
2031-0164	CTFPR16-4D	1"	1"	1.25"	6"	TP...43-	T22D	M3x8-D5	CL-12	XNS-0829	S2 S4	49.63
2031-0204	CTFPR20-4D	1-1/4"	1-1/4"	1.50"	6"	TP...43-	T22D	M3x8-D5	CL-12	XNS-0829	S2 S4	46.23

CTGPR TOP CLAMP STYLE TOOL HOLDERS 0° LEAD ANGLE • RIGHT HAND

CTGPR

- 11° Relief

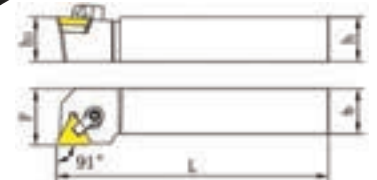

90° RIGHT HAND

INSERTS NOT INCLUDED

See pages 165-166 for spare parts. Replacement inserts shown on page 189.

Item#	Industry Ref. No.	Dimensions				Insert	Shim	Shim Screw	Clamp	Clamp Screw	Key	Price (F)
		h=h1	Shank Dia. b	Offset F	OAL L							
2015-1103	CTGPR12-3B	5/8"	5/8"	.75"	4-1/2"	TP...32-	T16D	M3x8-D5	CL-6	XNS-0520	S2 S2.5	52.68
2015-1123	CTGPR16-4D	3/4"	3/4"	1.00"	4-1/2"	TP...43-	T22D	M3x8-D5	CL-12	XNS-0229	S2 S2.5	89.28
2015-1163	CTGPR20-4D	1"	1"	1.25"	6"	TP...43-	T22D	M3x8-D5	CL-12	XNS-0229	S2 S2.5	60.76

DCLNR TOP & HOLE CLAMP STYLE TOOL HOLDERS -5° LEAD ANGLE • RIGHT HAND

DCLNR

- 0° Relief

Limited Supply!

RIGHT HAND



INSERTS NOT INCLUDED

See pages 165-166 for spare parts. Replacement inserts shown on pages 173-174.

Tool Holder Style	Shank	(Inch) OAL	Offset	Insert Style	Shim	Lock Pin	Clamp	Clamp Screw	Item#	Price (F)
20-4E	1-1/4	7	1-1/2	CN...43-	C1203B	THT0706	DLM4	LE06	2017-0204	56.94
20-5E	1-1/4	7	1-1/2	CN...54-	C1604B	THT0907	DLM4	LE06	2017-0205	59.57

INDEXABLE TURNING TOOL HOLDERS

DDJNR TOP & HOLE CLAMP STYLE TOOL HOLDERS -3° LEAD ANGLE • RIGHT HAND

DDJNR

- 0° Relief

INSERTS NOT INCLUDED

RIGHT HAND

Limited Supply!



See pages 165-166 for spare parts. Replacement inserts shown on pages 176-178.

Tool Holder Style	(Inch)			Insert Style	Shim	Lock Pin	Clamp	Clamp Screw	Item#	Price (F)
	Shank	OAL	Offset							
20-4E	1-1/4	7	1-1/2	DNM.-43.	D1504B	THT0706	DLM4	LE06	2018-0204	57.99

DTGNR TOP & HOLE CLAMP STYLE TOOL HOLDERS 0° LEAD ANGLE • RIGHT HAND

DTGNR

- 0° Relief

INSERTS NOT INCLUDED

Limited Supply!

RIGHT HAND



See pages 165-166 for spare parts. Replacement inserts shown on pages 186-188.

Tool Holder Style	(Inch)			Insert Style	Shim	Lock Pin	Clamp	Clamp Screw	Item#	Price (F)
	Shank	OAL	Offset							
12-3C	3/4	4-1/2	1	TNM.-32.	T1603B	THT0505	DLM3	LE05	2019-0123	37.87
16-3D	1	6	1-1/4	TNM.-32.	T1603B	THT0505	DLM3	LE05	2019-0163	44.14
16-4D	1	6	1-1/4	TNM.-43.	T2203B	THT0706	DLM4	LE06	2019-0164	46.89
20-4E	1-1/4	7	1-1/2	TNM.-43.	T2203B	THT0706	DLM4	LE06	2019-0204	59.03

DTJNR TOP & HOLE CLAMP STYLE TOOL HOLDERS -3° LEAD ANGLE • RIGHT HAND

DTJNR

- 0° Relief

INSERTS NOT INCLUDED

Limited Supply!

RIGHT HAND



See pages 165-166 for spare parts. Replacement inserts shown on pages 186-188.

Tool Holder Style	(Inch)			Insert Style	Shim	Lock Pin	Clamp	Clamp Screw	Item#	Price (F)
	Shank	OAL	Offset							
12-3C	3/4	5	1	TNM.-32.	T1603B	THT0505	DLM3	LE05	2020-0123	37.87
16-3D	1	6	1-1/4	TNM.-32.	T1603B	THT0505	DLM3	LE05	2020-0163	44.14
16-4D	1	6	1-1/4	TNM.-43.	T2203B	THT0706	DLM4	LE06	2020-0164	46.89
20-4E	1-1/4	7	1-1/2	TNM.-43.	T2203B	THT0706	DLM4	LE06	2020-0204	59.03

MCGNR PIN & CLAMP STYLE TOOL HOLDERS 90° Lead Angle • RIGHT HAND

MCGNR

- -5° Negative Rake

INSERTS NOT INCLUDED

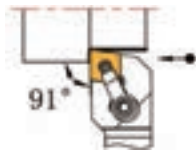

Limited Supply!

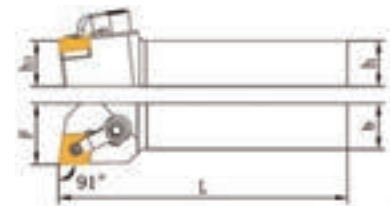

Item#	Industry Ref. No.	Dimensions				Insert	Shim	Lock Pin	Clamp	Clamp Screw	Key	Price (F)
		h=h1	Shank Dia. b	Offset F	OAL L							
2010-1124	MCGNR12-4C	3/4"	3/4"	1"	5"	CN..43.	C1203B	NL-0617	CL-12	XNS-0829	S2.5 S4	42.24
2010-1165	MCGNR16-5D	1"	1"	1-1/4"	6"	CN..54.	C1604B	NL-0822	CL-12	XNS-0829	S3 S4	52.06
2010-1204	MCGNR20-4D	1-1/4"	1-1/4"	1-1/2"	6"	CN..54.	C1604B	NL-0617	CL-20	XNS-0829	S3 S4	62.64
2010-1206	MCGNR20-5E	1-1/4"	1-1/4"	1-1/2"	7"	CN..54.	C1604B	NL-0822	CL-12	XNS-0829	S3 S4	65.51

See pages 165-166 for spare parts. Replacement inserts shown on pages 173-174.

INDEXABLE TURNING TOOL HOLDERS

MCLNR PIN & CLAMP STYLE TOOL HOLDERS -5° LEAD ANGLE • RIGHT HAND

MCLNR

- 0° Relief
- For turning and facing.

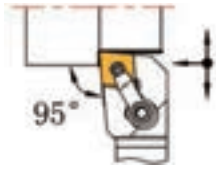

Limited Supply!

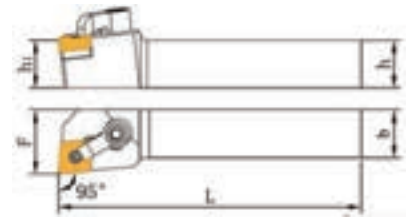

INSERTS NOT INCLUDED

See pages 165-166 for spare parts.

Item#	Industry Ref. No.	Dimensions				Insert	Shim	Lock Pin	Clamp	Clamp Screw	Key	Price (F)
		h=h1	Shank Dia. b	Offset F	OAL L							
2011-1204	MCLNR20-4D	1-1/4"	1-1/2"	1.50"	6"	CH...43..	C1203B	NL-0617	CL-12	XNS-0829	S2.5 S4	62.64
2011-1205	MCLNR20-5E	1-1/4"	1-1/4"	1.50"	7"	CH...54..	C1604B	NL-0822	CL-12	XNS-0829	S4	65.51

HARLINGEN® MCLNR PIN & CLAMP STYLE TOOL HOLDERS -5° LEAD ANGLE • RIGHT HAND

MCLNR

- 0° Relief
- For turning and facing.

Up to 30% Higher Productivity & Profitability!

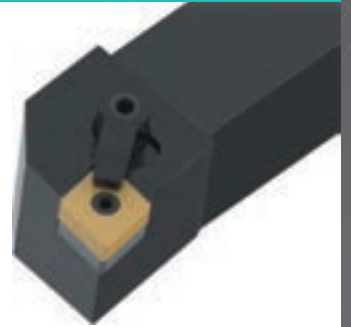
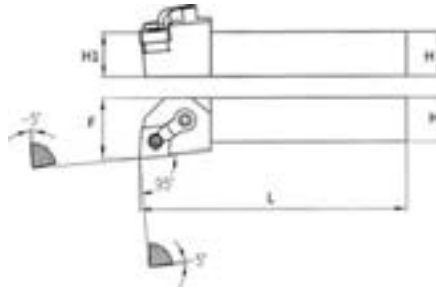
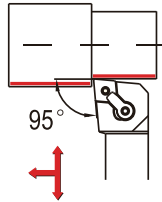

See pages 165-166 for spare parts. Replacement inserts shown on pages 173-174.

INSERTS NOT INCLUDED

Item#	Industry Ref. No.	Dimensions				Insert	Shim	Lock Pin	Clamp	Clamp Screw	Torx Wrench	Price (F)
		h=h1	Shank Dia. b	Offset F	OAL L							
9710-0109	MCLNR12-4B	3/4"	3/4"	1"	4-1/2"	CNMG4...	ICSN-433	NL-46	CK-20	STC-20	S3/32 S1/8	62.97
9710-0104	MCLNR16-4D	1"	1"	1-1/4"	6"	CNMG4...	ICSN-433	NL-46	CK-20	STC-20	S3/32 S1/8	68.28

MCLNR TOOL HOLDERS - RIGID CLAMP DESIGN -5° LEAD ANGLE • RIGHT HAND

TMCLNR

- 0° Relief

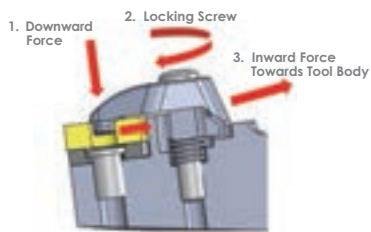

New Design!

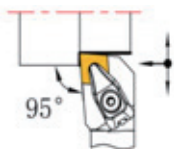

INSERTS NOT INCLUDED

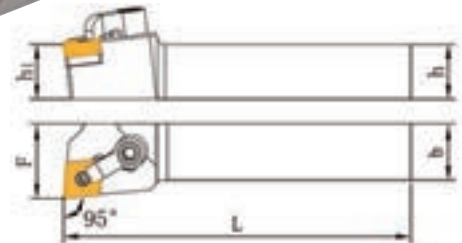

See page 152 for advantages.

See pages 165-166 for spare parts. Replacement inserts shown on pages 173-174.

Item #	Industry Ref. No.	Dimensions				Insert	Shim	Shim Screw	Clamp	Clamp Screw	Spring	Key	Price (F)
		h=h1	Shank Dia. b	Offset F	OAL L								
2011-1122	TMCLNR12-4B	3/4"	3/4"	1.00"	4.5"	CN...43..	C0903B	LYM0610	TP-2	MS0523	YB6512	S3	64.56
2011-1162	TMCLNR16-4D	1"	1"	1.25"	6"	CN...43..	C0903B	LYM0610	TP-2	MS0523	YB6512	S3	75.10
2011-1167	TMCLNR16-5D	1"	1"	1.25"	6"	CN...54..	C1604B	LYM0810	TP-4	MS0523	YB6512	S3	83.73
2011-1202	TMCLNR20-5E	1-1/4"	1-1/4"	1.50"	7"	CN...54..	C1604B	LYM0810	TP-4	MS0523	YB6512	S4	104.33

INDEXABLE TURNING TOOL HOLDERS

MDJNR PIN & CLAMP STYLE TOOL HOLDERS 3° LEAD ANGLE • RIGHT HAND

MDJNR

- 0° Relief
- For profiling and facing.

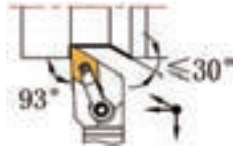

Limited Supply!



INSERTS NOT INCLUDED

See pages 165-166 for spare parts. Replacement inserts shown on pages 176-178.

Item#	Industry Ref. No.	Dimensions				Insert	Shim	Lock Pin	Clamp	Clamp Screw	Key	Price (F)
		h=h1	Shank Dia. b	Offset F	OAL L							
2012-1204	MDJNR20-4E	1-1/4"	1-1/4"	1.50"	7"	DN..43.	D1504B	NL-0617	CL-30	XNS-0829	S2.5 S4	67.87

HARLINGEN® MDJNR PIN & CLAMP STYLE TOOL HOLDERS 3° LEAD ANGLE • RIGHT HAND

MDJNR

- 0° Relief
- For turning and profiling.

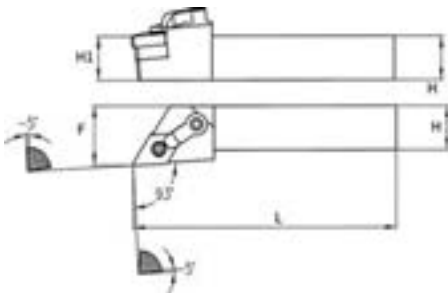

Up to 30% Higher Productivity & Profitability!

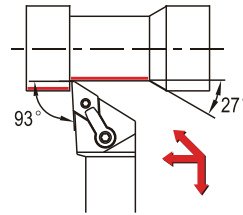

INSERTS NOT INCLUDED

See pages 165-166 for spare parts. Replacement inserts shown on pages 176-178.

Item#	Industry Ref. No.	Dimensions				Insert	Shim	Lock Pin	Clamp	Clamp Screw	Torx Wrench	Price (F)
		h=h1	Shank Dia. b	Offset F	OAL L							
9710-0110	MDJNR12-4B	3/4"	3/4"	1"	4-1/2"	DN..43.	ISDN-443	NL-46L	CK-23	STC-20	S3/32 S1/8	64.87

MDJN TOOL HOLDERS - RIGID CLAMP DESIGN 3° LEAD ANGLE • RIGHT HAND

TMDJNR

- 0° Relief
- For profiling and facing.

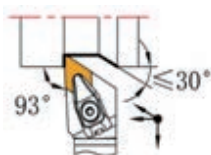
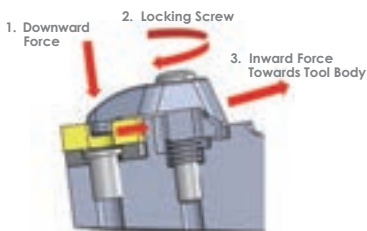

New Design!

INSERTS NOT INCLUDED

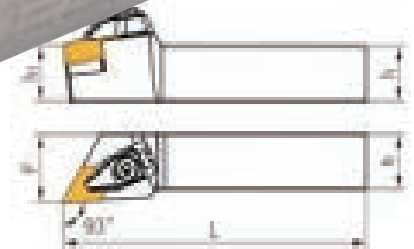

See page 152 for advantages.

See pages 165-166 for spare parts. Replacement inserts shown on pages 176-178.

Item#	Industry Ref. No.	Dimensions				Insert	Shim	Shim Screw	Clamp	Clamp Screw	Spring	Key	Price (F)
		h=h1	Shank Dia. b	Offset F	OAL L								
2012-1122	TMDJNR12-4B	3/4"	3/4"	1"	4-1/2"	DN..43.	D1504B	LYM0610	TP-2	MS0523	YB6512	S3	67.18
2012-1162	TMDJNR16-4D	1"	1"	1-1/4"	6"	DN..43.	D1504B	LYM0610	TP-2	MS0523	YB6512	S3	78.70

INDEXABLE TURNING TOOL HOLDERS

MDPNN PIN & CLAMP STYLE TOOL HOLDERS 27.5° LEAD ANGLE • NEUTRAL

MDPNN

- 0° Relief
- For turning and profiling.

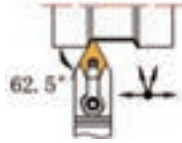

Limited Supply!

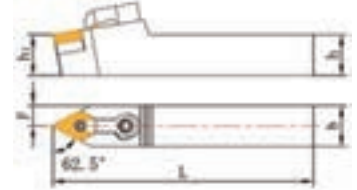

INSERTS NOT INCLUDED

See pages 165-166 for spare parts. Replacement inserts shown on pages 176-178.

Item#	Industry Ref. No.	Dimensions				Insert	Shim	Lock Pin	Clamp	Clamp Screw	Key	Price (F)
		h=h1	Shank Dia. b	Offset F	OAL L							
2024-0165	MDPNN16-5D	1"	1"	.50"	6"	DN...53.	D1904B	NL-0822	CL-30	XNS-0829	S2.5 S5	42.29
2024-0204	MDPNN20-4D	1-1/4"	1-1/4"	.63"	6"	DN...43.	D1504B	NL-0617	CL-30	XNS-0829	S2.5 S4	50.45

MRGNR PIN & CLAMP STYLE TOOL HOLDERS 0° LEAD ANGLE • RIGHT HAND

MRGNR

- 0° Relief
- For turning and profiling.

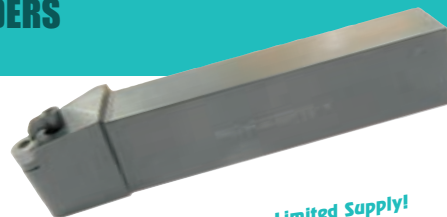
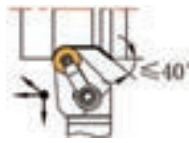

Limited Supply!

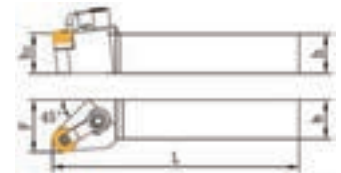

INSERTS NOT INCLUDED

See pages 165-166 for spare parts. Replacement inserts shown on page 179.

Item#	Industry Ref. No.	Dimensions				Insert	Shim	Lock Pin	Clamp	Clamp Screw	Key	Price (F)
		h=h1	Shank Dia. b	Offset F	OAL L							
2026-0123	MARGNR12-10B	3/4"	3/4"	1"	4-1/2"	RN...10T3MO	R1003B	NL-0413	CL-12	XNS-0829	S2 S4	37.62
2026-0163	MARGNR16-12D	1"	1"	1-1/4"	6"	RN...32.	R1203B	NL-0617	CL-12	XNS-0829	S2.5 S4	38.41

MARGNR PIN & CLAMP STYLE TOOL HOLDERS - RIGID CLAMP DESIGN 0° LEAD ANGLE • RIGHT HAND

TMRGNR

- 0° Relief

New Design!

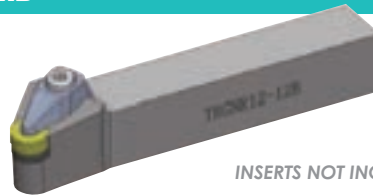

INSERTS NOT INCLUDED

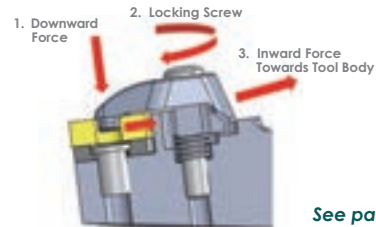

NEW

See pages 165-166 for spare parts. Replacement inserts shown on page 179.

See page 152 for advantages.

Item#	Industry Ref. No.	Dimensions				Insert	Shim	Shim Screw	Clamp	Clamp Screw	Spring	Key	Price (F)
		h=h1	Shank Dia. b	Offset F	OAL L								
2026-0120	TMRGNR12-10B	3/4"	3/4"	1"	4-1/2"	RN...10T3MO	R1003B	LYM0508	TP-1	MS0422	YB5512	S3	42.54
2026-0122	TMRGNR12-12B	3/4"	3/4"	1"	4-1/2"	RN...1204MO	R1203B	LYM0610	TP-2	MS0523	YB6512	S3	43.97
2026-0161	TMRGNR16-12D	1"	1"	1-1/4"	6"	RN...1204MO	R1203B	LYM0610	TP-2	MS0523	YB6512	S3	45.40

MSDNN PIN & CLAMP STYLE TOOL HOLDERS 45° LEAD ANGLE • NEUTRAL

MSDNN

- 0° Relief



INSERTS NOT INCLUDED

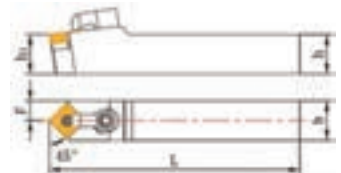

See pages 165-166 for spare parts. Replacement inserts shown on pages 181-183.

Item#	Industry Ref. No.	Dimensions				Insert	Shim	Lock Pin	Clamp	Clamp Screw	Key	Price (F)
		h=h1	Shank Dia. b	Offset F	OAL L							
2027-0083	MSDNN08-3A	1/2"	1/2"	.25"	4"	SN...32.	S0903B	NL-0412	CL-6	XNS-0520	S2, S2.5	49.10

INDEXABLE TURNING TOOL HOLDERS

MSDNN TOOL HOLDERS - RIGID CLAMP DESIGN 45° LEAD ANGLE • NEUTRAL HAND

TMSDNN

- 0° Relief

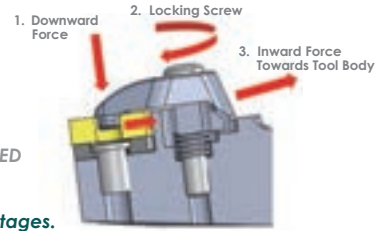
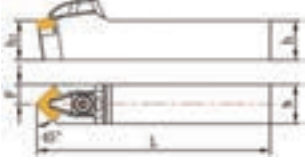

New Design!
INSERTS NOT INCLUDED

See pages 165-166 for spare parts. Replacement inserts shown on pages 181-183.

See page 152 for advantages.

Item#	Industry Ref. No.	Dimensions				Insert	Shim	Shim Screw	Clamp	Clamp Screw	Spring	Key	Price (F)
		h=h1	Shank Dia. b	Offset F	OAL L								
2027-0101	TMSDNN10-3B	5/8"	5/8"	0.31"	4-1/2"	SN...32	S0903B	LYM0508	TP-1	MS0422	YB5512	S3	54.00
2027-0121	TMSDNN12-4B	3/4"	3/4"	0.38"	4-1/2"	SN...43	S1203B	LYM0610	TP-2	MS0523	YB6512	S3	46.64
2027-0161	TMSDNN16-4D	1"	1"	0.5"	6"	SN...43	S1203B	LYM0610	TP-2	MS0523	YB6512	S3	71.81

MSKNR INDEXABLE TOOL HOLDERS- CLAMP ON 15° LEAD ANGLE • RIGHT HAND

MSKNR

- 0° Relief

Limited Supply!



INSERTS NOT INCLUDED

See pages 165-166 for spare parts. Replacement inserts shown on pages 181-183.

Tool Holder Style	Shank	OAL (Inch)	Offset	Insert Style	Shim	Lock Pin	Clamp	Clamp Screw	Item#	Price (F)
12-4C	3/4	5	1	SN...43	S1203B	NL-0617	CL-12	XNS-0829	2021-0124	42.12
16-4D	1	6	1-1/4	SN...43	S1203B	NL-0617	CL-12	XNS-0829	2021-0164	49.13
16-5D	1	6	1-1/4	SN...54	S1504B	NL-0822	CL-12	XNS-0829	2021-0165	52.06

MSRNR INDEXABLE TOOL HOLDERS- CLAMP ON 15° LEAD ANGLE • RIGHT HAND

MSRNR

- 0° Relief

Limited Supply!



INSERTS NOT INCLUDED

See pages 165-166 for spare parts. Replacement inserts shown on pages 181-183.

Tool Holder Style	Shank (Inch)	OAL	Offset	Insert Style	Shim	Lock Pin	Clamp	Clamp Screw	Item#	Price (F)
12-4B	3/4	4-1/2	.880	SN...43	S1203B	NL-0617	CL-12	XNS-0829	2028-0124	33.57
16-4D	1	6	1.130	SN...43	S1203B	NL-0617	CL-12	XNS-0829	2028-0164	45.34
16-5D	1	6	1.103	SN...54	S1504B	NL-0822	CL-12	XNS-0829	2028-0165	42.94
20-4D	1-1/4	6	1.353	SN...54	S1203B	NL-0617	CL-12	XNS-0829	2028-0204	53.53

MSRNR TOOL HOLDERS - RIGID CLAMP DESIGN 15° LEAD ANGLE • RIGHT HAND

TMSRNR

- 0° Relief

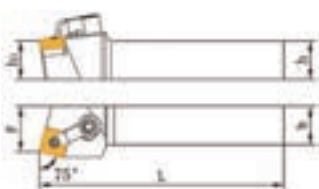

New Design!
INSERTS NOT INCLUDED

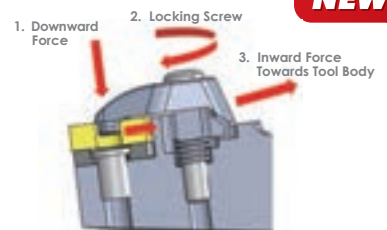

See pages 165-166 for spare parts. Replacement inserts shown on pages 181-183.

See page 152 for advantages.

Item#	Industry Ref. No.	Dimensions				Insert	Shim	Shim Screw	Clamp	Clamp Screw	Spring	Key	Price (F)
		h=h1	Shank Dia. b	Offset F	OAL L								
2028-0121	TMSRNR12-3B	3/4"	3/4"	0.88"	4-1/2"	SN...32	S0903B	LYM0508	TP-1	MS0422	YB5512	S3	41.68

INDEXABLE TURNING TOOL HOLDERS

MTENN PIN & CLAMP STYLE TOOL HOLDERS 60° LEAD ANGLE • NEUTRAL

MTENN

- 0° Relief

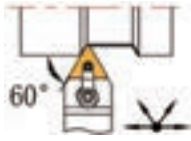

INSERTS NOT INCLUDED



Item#	Industry Ref. No.	Dimensions				Insert	Shim	Lock Pin	Clamp	Clamp Screw	Key	Price (F)
		h=h1	Shank Dia. b	Offset F	OAL L							
2029-0082	MTENN08-2A	1/2"	1/2"	0.25"	4"	TN...22	---	M-ZX0410	CL-6	XNS-0520	S2 S2.5	48.31
2029-0123*	MTENN12-3B	3/4"	3/4"	0.38"	4-1/2"	TN...33	T1603B	NL-0414	CL-6	XNS-0520	S2 S2.5	28.73
2029-0124	MTENN12-4B	3/4"	3/4"	0.38"	4-1/2"	TN...43	T2203B	NL-0617	CL-12	XNS-0829	S2.5 S4	55.70
2029-0205*	MTENN20-5E	1-1/4"	1-1/4"	0.63"	7"	TN...54	T2704B	NL-0822	CL-12	XNS-0829	S3 S4	49.12

See pages 165-166 for spare parts. Replacement inserts shown on pages 186-188.

*Limited Supply

MTENN TOOL HOLDERS - RIGID CLAMP DESIGN 60° LEAD ANGLE • NEUTRAL

TMTENN

- 0° Relief

New Design!

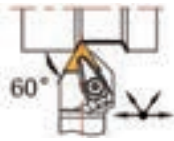

INSERTS NOT INCLUDED

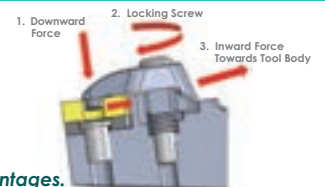

See pages 165-166 for spare parts. Replacement inserts shown on pages 186-188.

See page 152 for advantages.

Item#	Industry Ref. No.	Dimensions				Insert	Shim	Shim Screw	Clamp	Clamp Screw	Spring	Key	Price (F)
		h=h1	Shank Dia. b	Offset F	OAL L								
2029-0120	TTENN12E-3B	3/4"	3/4"	0.45"	4-1/2"	TN...33	T1603B	LYM0508	TP-1	MS0422	YB5512	S3	39.31
2029-0161	TTENN16E-4D	1"	1"	0.58"	6"	TN...43	T2203B	LYM0610	TP-2	MS0523	YB6512	S3	73.34

MTFNR PIN & CLAMP TOOL HOLDERS 0° LEAD ANGLE • RIGHT HAND

MTFNR

- 0° Relief

INSERTS NOT INCLUDED

See pages 165-166 for spare parts. Replacement inserts shown on pages 186-188.



Limited Supply!

Tool Holder Style	Shank (Inch)	OAL	Offset	Insert Style	Shim	Lock Pin	Clamp	Clamp Screw	RH Item#	Price (F)
8-2A	1/2	4	1/2	TN...22	---	NL-0409	CL-6	XNS-0520	2022-0082	39.93
10-2B	5/8	4-1/2	5/8	TN...22	---	NL-0409	CL-6	XNS-0520	2022-0102	37.43
10-3B	5/8	4-1/2	5/8	TN...33	T1603B	NL-0414	CL-6	XNS-0520	2022-0103	44.77
12-3C	3/4	5	3/4	TN...33	T1603B	NL-0414	CL-6	XNS-0520	2022-0123	41.55
16-3D	1	6	1-1/4	TN...33	T1603B	NL-0414	CL-6	XNS-0520	2022-0163	48.56
16-4D	1	6	1-1/4	TN...43	T2203B	NL-0617	CL-12	XNS-0829	2022-0164	51.49
20-4E	1-1/4	7	1-1/2	TN...43	T2203B	NL-0617	CL-12	XNS-0829	2022-0204	64.94

MTFNR TOOL HOLDERS - RIGID CLAMP DESIGN 0° LEAD ANGLE • RIGHT HAND

TMTFNR

- 0° Relief



INSERTS NOT INCLUDED

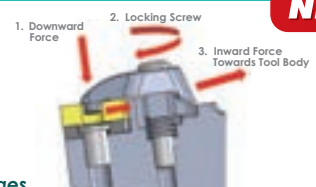

NEW

See pages 165-166 for spare parts. Replacement inserts shown on pages 186-188.

See page 152 for advantages.

Item#	Industry Ref. No.	Dimensions				Insert	Shim	Shim Screw	Clamp	Clamp Screw	Spring	Key	Price (F)
		h=h1	Shank Dia. b	Offset F	OAL L								
2022-0100	TMTFNR 10-3B	5/8"	5/8"	0.75"	4-1/2"	TN...33	T1603B	LYM0508	TP-1	MS0422	YB5512	S3	52.91

INDEXABLE TURNING TOOL HOLDERS

MTGNR PIN & CLAMP STYLE TURNING TOOL HOLDERS 0° LEAD ANGLE • RIGHT HAND

MTGNR

- 0° Relief
- For turning to square shoulders.



Limited Supply!

Tool Holder Style	Shank	(Inch) OAL	Offset	Insert Style	Shim	Lock Pin	Clamp	Clamp Screw	Item#	Price (F)
8-2A	1/2	4	0.630	TNMG-22.	-----	M-7X0418	CL-6	XNS-0520	2013-1082	39.93
10-2B	5/8	4-1/2	0.750	TNMG-22.	-----	M-7X0440	CL-6	XNS-0520	2013-1102	37.43
10-3B	5/8	4-1/2	0.750	TNMG-33.	T1603B	NL-0414	CL-6	XNS-0520	2013-1103	44.77
12-3B	3/4	4-1/2	1	TNMG-33.	T1603B	NL-0414	CL-6	XNS-0520	2013-1123	50.27
85-4E	1-1/4	7	1-1/4	TNMG-43.	T2203B	NL-0617	CL-12	XNS-0829	2013-1854	64.94
20-4E	1-1/4	7"	1-1/2	TNMG-43.	T2203B	NL-0617	CL-12	XNS-0829	2013-1204	64.94

INSERTS NOT INCLUDED

See pages 165-166 for spare parts. Replacement inserts shown on pages 186-188.

MTGNR TOOL HOLDERS - RIGID CLAMP DESIGN 0° LEAD ANGLE • RIGHT HAND

TMTGNR

- 0° Relief
- For turning to square shoulders.

New Design!



INSERTS NOT INCLUDED

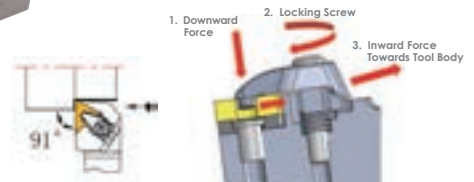

See pages 165-166 for spare parts. Replacement inserts shown on pages 186-188.

See page 152 for advantages.

Item#	Industry Ref. No.	Dimensions				Insert	Shim	Shim Screw	Clamp	Clamp Screw	Spring	Key	Price (F)
		h=h1	Shank Dia. b	Offset F	OAL L								
2013-1101	TMTGNR10-3B	5/8"	5/8"	1"	4-1/2"	TN...33.	T1603B	LYM0508	TP-1	MS0422	YB5512	S3	52.91
2013-1121	TMTGNR12-3B	3/4"	3/4"	1"	4-1/2"	TN...33.	T1603B	LYM0508	TP-1	MS0422	YB5512	S3	56.86
2013-1160	TMTGNR16-3D	1"	1"	1-1/4"	6"	TN...33.	T1603B	LYM0508	TP-1	MS0422	YB5512	S3	74.21
2013-1161	TMTGNR16-4D	1"	1"	1-1/4"	6"	TN...43.	T2203B	LYM0610	TP-2	MS0523	YB6512	S3	79.49

MTJNR PIN & CLAMP TOOL HOLDERS 0° LEAD ANGLE • RIGHT HAND

MTJNR

- 0° Relief

Limited Supply!



INSERTS NOT INCLUDED

See pages 165-166 for spare parts. Replacement inserts shown on pages 186-188.

Tool Holder Style	Shank	(Inch) OAL	Offset	Insert Style	Shim	Lock Pin	Clamp	Clamp Screw	Item#	Price (F)
16-3D	1	6	1-1/4	TN...33.	T1603B	NL-0414	CL-6	XNS-0520	2023-0163	56.23
16-4D	1	6	1-1/4	TN...43.	T2203B	NL-0617	CL-12	XNS-0829	2023-0164	51.49
20-4E	1-1/4	7	1-1/2	TN...43.	T2203B	NL-0617	CL-12	XNS-0829	2023-0204	64.94

MTJNR TOOL HOLDERS - RIGID CLAMP DESIGN -3° LEAD ANGLE • RIGHT HAND

TMTJNR

- 0° Relief

New Design!

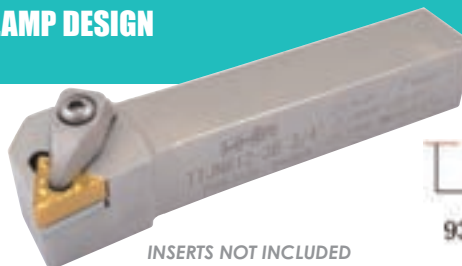
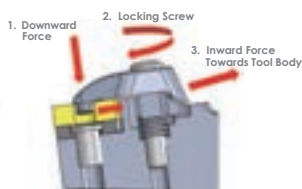

INSERTS NOT INCLUDED



See page 152 for advantages.

See pages 165-166 for spare parts. Replacement inserts shown on pages 186-188.

Item#	Industry Ref. No.	Dimensions				Insert	Shim	Shim Screw	Clamp	Clamp Screw	Spring	Key	Price (F)
		h=h1	Shank Dia. b	Offset F	OAL L								
2023-0120	TMTJNR12-3B	3/4"	3/4"	1"	4-1/2"	TN...33.	T1603B	LYM0508	TP-1	MS0422	YB5512	S3	63.50
2023-0160	TMTJNR16-3D	1"	1"	1-1/4"	6"	TN...33.	T1603B	LYM0508	TP-1	MS0422	YB5512	S3	66.46
2023-0161	TMTJNR16-4D	1"	1"	1-1/4"	6"	TN...43.	T2203B	LYM0610	TP-2	MS0523	YB6512	S3	70.46

INDEXABLE TURNING TOOL HOLDERS

MVJNR PIN & CLAMP TOOL HOLDERS -3° LEAD ANGLE • RIGHT HAND

MVJNR



INSERTS NOT INCLUDED

- 0° Relief
- For turning and profiling.

Tool Holder Style	(Inch)		Offset	Insert Style	Shim	Lock Pin	Clamp	Clamp Screw	Item#	Price (F)
	Shank	OAL								
16-4D	1	6	1-1/4	VNMG-43.	V2203B	NL-0617	CL-30	XNS-0829	2014-1164	81.50
20-3E	1-1/4	7	1-1/2	VNMG-33.	V1603B	NL-0414	CL-30	XNS-0829	2014-1203*	62.59
20-4E	1-1/4	7	1-1/2	VNMG-43.	V2203B	NL-0617	CL-30	XNS-0829	2014-1204*	66.69

See pages 165-166 for spare parts. Replacement inserts shown on pages 192-193.

*Limited Supply

HARLINGEN® MVJNR PIN & CLAMP TOOL HOLDERS -3° LEAD ANGLE • RIGHT HAND

MVJNR

- 3-Degree Lead Angle for Turning or Profiling
- USE VNMG332 INSERT

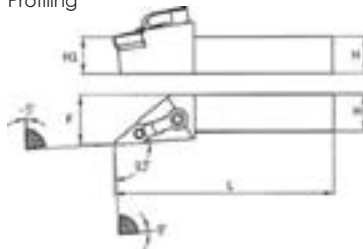
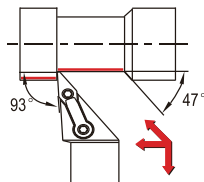

Up to 30% Higher Productivity & Profitability!



INSERTS NOT INCLUDED

See pages 165-166 for spare parts. Replacement inserts shown on pages 192-193.

Item#	Industry Ref. No.	Dimensions				Insert	Shim	Lock Pin	Clamp	Clamp Screw	Torx Wrench		Price (F)
		h=h1	Shank Dia. b	Offset F	OAL L						S5/64	S5/32	
9710-0195	MVJNR12-3B	3/4"	3/4"	1"	4-1/2"	VN...33.	IVSN-322	NL-34L	CK-43	STC-4	S5/64	S5/32	76.21

MVJNR TOOL HOLDERS - RIGID CLAMP DESIGN -3° LEAD ANGLE • RIGHT HAND

TMVJNR

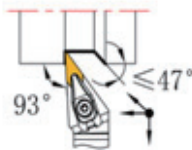
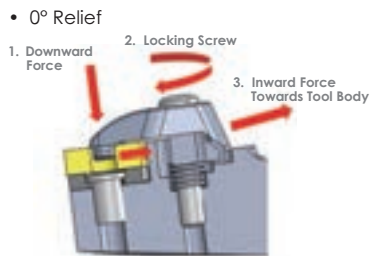

New Design!

INSERTS NOT INCLUDED

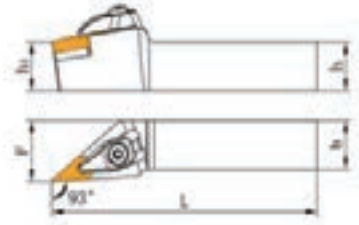

See page 152 for advantages.

See pages 165-166 for spare parts. Replacement inserts shown on pages 192-193.

Item #	Industry Ref. No.	Dimensions				Insert	Shim	Shim Screw	Clamp	Clamp Screw	Spring	Key	Price (F)
		h=h1	Shank Dia. b	Offset F	OAL L								
2014-1120	TMVJNR12-3B	3/4"	3/4"	1.00"	4-1/2"	VN...33.	V1603B	LYM0508	TP-3	MS0422	YB5512	S3	68.15
2014-1160	TMVJNR16-3D	1"	1"	1.25"	6"	VN...33.	V1603B	LYM0508	TP-3	MS0422	YB5512	S3	82.32

MVVNN PIN & CLAMP TOOL HOLDERS -17.5° LEAD ANGLE • NEUTRAL

MVVNN

- 0° Relief

Limited Supply!



INSERTS NOT INCLUDED

See pages 165-166 for spare parts. Replacement inserts shown on pages 192-193.

Tool Holder Style	(Inch)		Insert Style	Shim	Lock Pin	Clamp	Clamp Screw	Item#	Price (F)
	Shank	OAL							
16-4D	1	6	VNMG-43.	V2203B	NL-0617	CL-30	XNS-0829	2030-0164	61.90

INDEXABLE TURNING TOOL HOLDERS

Celebrating
2022

MVVNN TOOL HOLDERS - RIGID CLAMP DESIGN 17.5° LEAD ANGLE • NEUTRAL HAND

TMVVNN

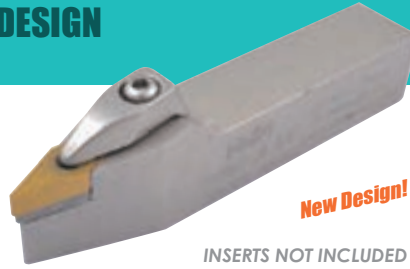
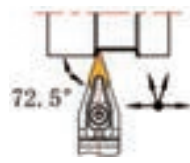
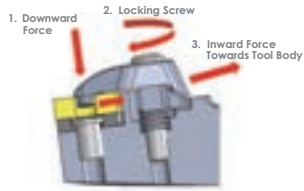

INSERTS NOT INCLUDED

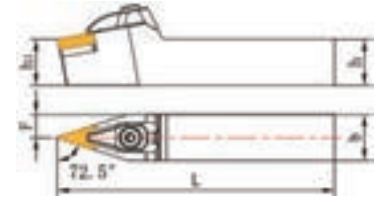

See page 152 for advantages.

See pages 165 for spare parts. Replacement inserts shown on pages 192-193.

Item#	Industry Ref. No.	Dimensions				Insert	Shim	Shim Screw	Clamp	Clamp Screw	Spring	Key	Price (F)
		h=h1	Shank Dia. b	Offset F	OAL L								
2030-0120	TMVVNN12-3B	3/4"	3/4"	0.38"	4-1/2"	VN...33.	V1603B	LYM0508	TP-3	MS0422	YB5512	S3	62.52
2030-0160	TMVVNN16-3D	1"	1"	0.50"	6"	VN...33.	V1603B	LYM0508	TP-3	MS0422	YB5512	S3	72.55

MWLN R INDEXABLE TOOL HOLDERS- CLAMP ON -5° LEAD ANGLE • RIGHT HAND

MWLN R

Limited Supply!

See pages 165-166 for spare parts. Replacement inserts shown on pages 194-195.

INSERTS NOT INCLUDED

Tool Holder Style	Shank (Inch)	OAL	Insert Style	Shim	Lock Pin	Clamp	Clamp Screw	Item#	Price (F)
16-3C	1	5	WNM.-32.	W0603B	NL-0414	CL-6	XNS-0520	2025-0162	53.69
16-3D	1	6	WNM.-32.	W0603B	NL-0414	CL-6	XNS-0520	2025-0163	61.90
16-4D	1	6	WNM.-43.	W0803B	NL-0617	CL-12	XNS-0829	2025-0164	48.40

HARLINGEN® MWLN R PIN & CLAMP TOOL HOLDERS -5° LEAD ANGLE • RIGHT HAND

MWLN R

- 5-Degree Lead Angle for Turning or Profiling
- USE WNMG332 INSERT

Up to 30% Higher Productivity & Profitability!

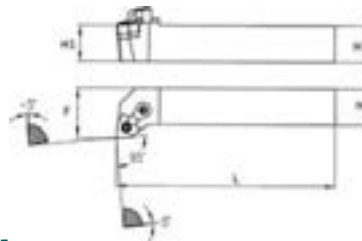
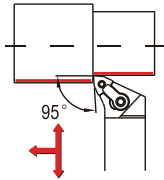

INSERTS NOT INCLUDED

See pages 165-166 for spare parts. Replacement inserts shown on pages 194-195.

Item#	Industry Ref. No.	Dimensions				Insert	Shim	Lock Pin	Clamp	Clamp Screw	Torx Wrench	Price (F)
		h=h1	Shank Dia. b	Offset F	OAL L							
9710-0205	MWLN R12-3B	3/4"	3/4"	1"	4-1/2"	WN...33.	IWSN-322	NL-34L	CK-6	STC-5	S5/64 S5/32	62.97

MWLN R TOOL HOLDERS - RIGID CLAMP DESIGN -5° LEAD ANGLE • RIGHT HAND

TMWLN R

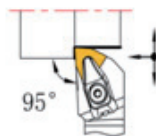
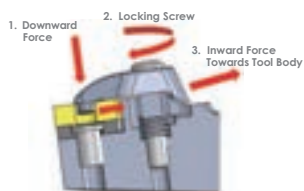

INSERTS NOT INCLUDED



See page 152 for advantages.

See pages 165-166 for spare parts. Replacement inserts shown on pages 194-195.

Item #	Industry Ref. No.	Dimensions				Insert	Shim	Shim Screw	Clamp	Clamp Screw	Spring	Key	Price (F)
		h=h1	Shank Dia. b	Offset F	OAL L								
2025-0100	TMWLN R10-3B	5/8"	5/8"	0.75"	4-1/2"	WN...33.	W0603B	LYM0508	TP-1	MS0422	YB5512	S3	54.79
2025-0121	TMWLN R12-4B	3/4"	3/4"	1"	4-1/2"	WN...43.	W0803B	LYM0610	TP-2	MS0523	YB6512	S3	64.35
2025-0166	TMWLN R16-4D	1"	1"	1-1/4"	6"	WN...43.	W0803B	LYM0610	TP-2	MS0523	YB6512	S3	71.81

CUTTING & CARBIDE TOOLS

INDEXABLE TURNING TOOL HOLDERS

SCLCR SCREW TYPE TOOL HOLDERS -5° LEAD ANGLE • RIGHT HAND

SCLCR

- 7° Relief



INSERTS NOT INCLUDED



See pages 165-166 for spare parts. Replacement inserts shown on page 172.

Item#	Industry Ref. No.	Dimensions				Insert	Clamp Screw	Key	Price (F)
		h=h1	Shank Dia. b	Offset F	OAL L				
2039-0083	SCLCR8-3A	1/2"	1/2"	0.63"	4"	CC...33.5.	M4 x 10	T15	32.74
2039-0103	SCLCR10-3B	5/8"	5/8"	0.75"	4-1/2"	CC...33.5.	M4 x 10	T15	34.10
2039-0123	SCLCR12-3B	3/4"	3/4"	1"	4-1/2"	CC...33.5.	M4 x 10	T15	40.35
2039-0164	SCLCR16-4D	1"	1"	1-1/4"	6"	CC...43.	M5 x 12	T20	43.92

HARLINGEN® SCLCR SCREW TYPE TOOL HOLDERS -5° LEAD ANGLE • RIGHT HAND

SCLCR

- 5-Degree Lead Angle for Turning, Profiling or facing
- USE CCMT32.52 INSERT

Up to 30% Higher Productivity & Profitability!

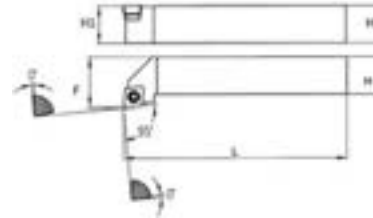
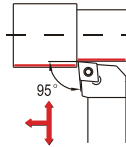

INSERTS NOT INCLUDED

See pages 165-166 for spare parts. Replacement inserts shown on page 172.

Item#	Industry Ref. No.	Dimensions				Insert	Shim	Shim Screw	Insert Screw	Torx Wrench	Price (F)
		h=h1	Shank Dia. b	Offset F	OAL L						
9710-0018	SCLCR12-3B	3/4"	3/4"	1"	4-1/2"	CC...32...	SKCP-343	SRS-3	MS-1156	S3.5 T15	53.30

SDJCR SCREW TYPE TOOL HOLDERS -3° LEAD ANGLE • RIGHT HAND

SDJCR

- 7° Relief

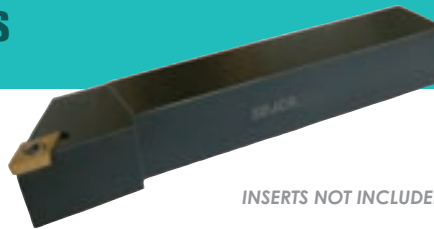

INSERTS NOT INCLUDED

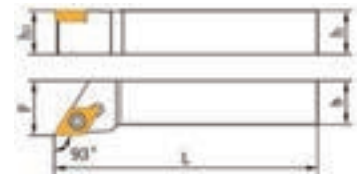

See pages 165-166 for spare parts. Replacement inserts shown on pages 175-176.

Item#	Industry Ref. No.	Dimensions				Insert	Clamp Screw	Key	Price (F)
		h=h1	Shank Dia. b	Offset F	OAL L				
2033-0062	SDJCR06-2J	3/8"	3/8"	0.50"	3-1/2"	DC...21.5.	M2.5 x 6	T8	31.94
2033-0083	SDJCR08-3A	1/2"	1/2"	0.63"	4"	DC...32.5.	M4 x 10	T15	25.54
2033-0103	SDJCR10-3B	5/8"	5/8"	0.75"	4-1/2"	DC...32.5.	M4 x 10	T15	43.51
2033-0123	SDJCR12-3B	3/4"	3/4"	1"	4-1/2"	DC...32.5.	M4 x 10	T15	47.90

SDNCR SCREW TYPE TOOL HOLDERS -27.5° LEAD ANGLE • RIGHT HAND

SDNCR

- 7° Relief

Limited Supply!



INSERTS NOT INCLUDED

Tool Holder Style	Shank	(Inch) OAL L	Offset	Insert Style	Screw	Item#	Price (F)
6-2J	3/8	3-1/2	3/16	DCMT-21.5	M2.5X6	2032-0062	24.49
10-3B	5/8	4-1/2	5/16	DCMT-32.5	M4X10	2032-0103	26.25
16-4D	1	6	1/2	DCMT-43.	M5X12	2032-0164	33.26

See pages 165-166 for spare parts. Replacement inserts shown on pages 175-176.

INDEXABLE TURNING TOOL HOLDERS

SRDCN SCREW TYPE TOOL HOLDERS 0° LEAD ANGLE • NEUTRAL

- 7° Relief



INSERTS NOT INCLUDED

See pages 165-166 for spare parts. Replacement inserts shown on page 179.

Item#	Industry Ref. No.	Dimensions				Insert	Clamp Screw	Key	Price (F)
		h=h1	Shank Dia. b	Offset F	OAL L				
2037-0106	SRDCN06-6A	3/8"	3/8"	3/16"	4"	RC...0602	M2.5 x 6	T8	33.94
2037-1210	SRDCN08-08A	1/2"	1/2"	1/4"	4"	RC...0803MD	M3 x 8	T8	32.52
2037-1612	SRDCN10-10B	5/8"	5/8"	.31"	4-1/2"	RC...1013MD	M4 x 10	T15	38.74

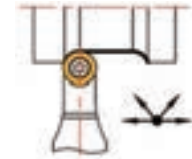

SRGCR SCREW TYPE TOOL HOLDERS 0° LEAD ANGLE • RIGHT HAND

- 7° Relief



Limited Supply!

INSERTS NOT INCLUDED

Tool Holder Style	(Inch)			Insert Style	Screw	Item#	Price (F)
	Shank	OAL	Offset				
12-2B	3/4	4-1/2	1	RCMT-22.	M2.5x6	2038-0122	32.45
16-3D	1	6	1-1/4	RCMT-32.5	M4x10	2038-0163	39.01
20-2D	1-1/4	6	1-1/2	RCMT-22.	M2.5x6	2038-0202	38.72
20-3D	1-1/4	6	1-1/2	RCMT-32.5	M4x10	2038-0203	40.52

See pages 165-166 for spare parts. Replacement inserts shown on page 179.

STGCR SCREW TYPE TOOL HOLDERS 0° LEAD ANGLE • RIGHT HAND



INSERTS NOT INCLUDED

Item#	Industry Ref. No.	Dimensions				Insert	Clamp Screw	Key	Price (F)
		h=h1	Shank Dia. b	Offset F	OAL L				
2036-0062	STGCR06-2J	3/8"	3/8"	0.50"	2-1/2"	TC...21-5.	M2.5 x 6	T8	34.05
2036-0082	STGCR08-2J	1/2"	1/2"	0.63"	3-1/2"	TC...21-5.	M2.5 x 6	T8	32.69
2036-0103	STGCR10-3B	5/8"	5/8"	0.75"	4-1/2"	TC...32-5.	M4 x 10	T15	39.34
2036-0123*	STGCR12-3B	3/4"	3/4"	1"	4-1/2"	TC...32-5.	M4 x 10	T15	28.22

See pages 165-166 for spare parts. Replacement inserts shown on page 185.

*Limited Supply

SVJBR SCREW TYPE TOOL HOLDERS -3° LEAD ANGLE • RIGHT HAND

- 5° Relief

INSERTS NOT INCLUDED

Item#	Industry Ref. No.	Dimensions				Insert	Clamp Screw	Key	Price (F)
		h=h1	Shank Dia. b	Offset F	OAL L				
2034-0062	SVJBR06-2J	3/8"	3/8"	0.50"	3-1/2"	VB...21.5.	M2.5 x 6	T8	33.94
2034-0082	SVJBR08-2A	1/2"	1/2"	0.63"	4"	VB...21.5.	M2.5 x 6	T8	32.52
2034-0083	SVJBR08-3A	1/2"	1/2"	0.63"	4"	VB...33.	M4 x 10	T15	36.60
2034-0102	SVJBR10-2B	5/8"	5/8"	0.75"	4"	VB...21.5.	M4 x 10	T15	47.11
2034-0123	SVJBR12-3B	3/4"	3/4"	1"	4-1/2"	VB...33.	M4 x 10	T15	49.92
2034-0163	SVJBR16-3D	1"	1"	1-1/4"	6"	VB...33.	M4 x 10	T15	62.30

See pages 165-166 for spare parts. Replacement inserts shown on page 191.

SVVBN SCREW TYPE TOOL HOLDERS -17.5° LEAD ANGLE • NEUTRAL

- 5° Relief

Limited Supply!

INSERTS NOT INCLUDED



See pages 165-166 for spare parts. Replacement inserts shown on page 191.

Tool Holder Style	(Inch)			Insert Style	Screw	Item#	Price (F)
	Shank	OAL	Offset				
6-2J	3/8	3-1/2	1/2	VBMT-22.	M2.5x6	2035-0062	21.16
8-3A	1/2	4	5/8	VBMT-33.	M4X10	2035-0083	21.16
10-2B	5/8	4-1/2	3/4	VBMT-22.	M2.5x6	2035-0102	25.08
12-3B	3/4	4-1/2	1	VBMT-33.	M4x10	2035-0123	28.73
16-3D	1	6	1-1/4	VBMT-33.	M4x10	2035-0163	36.30
16-4D	1	6	1-1/2	VBMT-43.	M5x12	2035-0164	36.30

SPARE PARTS FOR INDEXABLE TOOLS

SCREWS FOR INDEXABLE TOOLING METRIC THREAD

Item#	Style	Size	Wrench Used	Price (F)
2100-0060	M2 x 4	M2 x 4	T6	3.63
2100-0061	M2 x 5	M2 x 5	T6	3.63
2100-0065	M2.2 x 6	M2.2 x 6	T6	3.63
2100-1066	M2.5 x 3.5	M2.5 x 3.5	T8	3.63
2100-0067	M2.5 x 5	M2.5 x 5	T8	3.63
2100-0070	M2.5 x 6	M2.5 x 6	T8	3.63
2100-0066	M2.5 x 7	M2.5 x 7	T8	3.63
2100-0072	M2.5 x 8	M2.5 x 8	T8	4.13
2100-0063	M3 x 7	M3 x 7	T10	4.40
2100-0003	M3.0 x 8	M3.0 x 8	T10	4.41
2100-0073	M3.5 x 8	M3.5 x 8	T15	4.13
2100-1080	M3.5 x 10	M3.5 x 10	T16	4.40
2100-0083	M3.5 x 11	M3.5 x 11	T15	3.97
2100-0084	M3.5 x 12	M3.5 x 12	T15	4.36
2100-0069	M4.0 x 8	M4.0 x 8	T15	4.40
2100-0071	M4.0 x 9	M4.0 x 9	T15	4.03
2100-0074	M4.0 x 10	M4.0 x 10	T15	5.39
2100-0064	M4.0 x 11	M4.0 x 11	T15	5.28
2100-0075	M5.0 x 10	M5.0 x 10	T20	5.39
2100-0076	M5.0 x 12	M5.0 x 12	T20	5.28
2100-0077	M5.0 x 14	M5.0 x 14	T20	6.01
2100-1078	M5.0 x 16	M5.0 x 16	T20	6.01
2100-0088*	M5.0 x 18	M5.0 x 18	T20	6.01
2100-0026	M6.0 x 20	M6.0 x 20	S4	3.77
2100-0078	CTFP-M5	M5.0 x 13	S3	3.08
2100-0027	DLS5 M6 x 26	M6 x 26	S4	4.37
2100-0082	GB70-85 M4 x 12	M4 x 16	S3	3.97
2100-0087	GB70-85 M5 x 14	M5 x 19	S4	4.36
2100-0026	GB/T70.2 M6 x 20	M6 x 25	S5	3.77
2100-1070	I86M 4 x 7	M4X7	T15	4.03
2100-0071	I86M 4 x 9	M4X9	T15	4.03



*Limited Supply

Item#	Style	Size	Wrench Used	Price (F)
2100-4301	LYM0308			4.32
2100-4300	LYM0508			4.32
2100-4303	LYM0610			4.32
2100-4305	LYM0810			4.32
2100-0005	LE05	M5 x 23	S3	2.56
2100-0007	LE06	M6 x 26	S4	2.56
2100-0089	M3x6.5-D5	M3 x 6.5	S2	3.60
2100-0070	MLD-M25	M2.5 x 6	T8	3.63
2100-0084	MLD-M35	M3.5 x 12	T15	4.36
2100-0074	MLD-M40	M4 x 10	T15	5.39
2100-0076	MLD-M50	M5 x 12	T20	5.28
2100-4350	MS0422		S3	4.32
2100-4353	MS0523		S3	4.32
5820-2001	PM4 x 8	M4.0 x 12	S3	3.77
2100-0105	PM5 x 8	M5.0 x 12	S3	5.48
2100-0106	PM6 x 12	M6.0 x 17	S4	5.48
2100-0107	PM8 x 12	M8.0 x 17	S5	5.48
2100-0108	PM8 x 16	M8.0 x 21	S5	5.48
2100-0008	SDN535	M5 (Ext.) M3.5 (Int.)		4.92
2100-0009	SDN850	M8 (Ext.) M5 (Int.)		4.92
2100-0051	SM815.18L	M8 x 1 x 18	S4	5.48
2100-0052	SM81018.22L	M8 X 1 X 22	S4	5.48
2109-0031	SRS-3			5.48
2109-0158	STC-4			5.48
2109-0154	STC-5			5.48
2109-0150	STC-20			5.48
2100-0001	XNS-0520	M5X20		4.13
2100-0004	XNS-0620	M6X20		4.13
2100-0002	XNS-0829	M8X20		4.13
2100-0089	M3X6.5 D5	M3X6.5	S2	3.60



XNS STYLE SCREWS:

XNS-0520 Shown

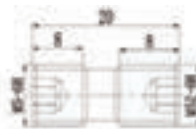

XNS-0620 Shown

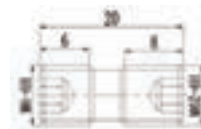

XNS-0820 Shown

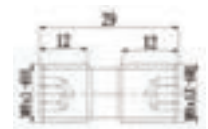

HEX KEY WRENCHES



Item#	Style	Size	Price (F)	Item#	Style	Size	Price (F)
2100-1085	S5/64	5/64	3.20	2100-0086	S2.5	2.5mm	3.20
2100-1092	S3/32	3/32	3.20	2100-1084	S3	3mm	3.20
2100-1094	S5/32	5/32	3.20	2100-1088	S3.5	3.5mm	3.20
2100-1095	S1/8	1/8	3.20	2100-1089	S4	4mm	3.20
2100-0085	S2	2mm	3.20	2100-1090	S5	5mm	3.20

TORX WRENCHES

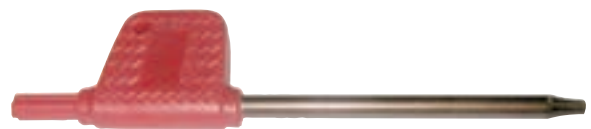

Item#	Size	Price (F)	Item#	Size	Price (F)
2100-0091	T-6	3.10	2100-0095	T-15	3.10
2100-0092	T-8	3.10	2100-0096	T-20	3.10
2100-0093	T-9	3.10	2100-0097	T-25	3.10
2100-0094	T-10	3.10			

SPARE PARTS FOR INDEXABLE TOOLS

CLAMPS FOR INDEXABLE TOOLING METRIC THREAD

Item#	Style	Price (F)
2109-0100	CK-20	9.08
2109-0110	CK-23	9.08
2109-0108	CK-43	9.08
2100-0006	CL-6	9.08
2100-0012	CL-12	9.08
2100-0020	CL-20	9.08
2100-0030	CL-30	9.08
2100-0031	CTF-5/CTFPN-5	6.50
2100-0032	DLM2	6.96
2100-0033	DLM3/TP-1	6.96
2100-0034	DLM4/TP-3	6.96



Item#	Style	Price (F)
2100-0015	MTH0820	7.01
2100-0011	TNSB-2B	7.15
2100-0010	TNSB-3B	7.15
2100-2901	TP-1	7.15
2100-2902	TP-2	7.15
2100-2903	TP-3	7.15
2100-2904	TP-4	7.15



SHIMS FOR INDEXABLE TOOLING

Item#	Style	Price (F)
2100-0903	C0903B	6.44
2100-1203	C1203B	4.52
2100-1604	C1604B	4.52
2100-1904	C1904B	4.46
2100-1103	D1103B	2.13
2100-1504	D1504B	4.52
2100-1905*	D1904B	1.41
2109-0002	IDSN-443	5.00
2109-0001	ICSN-433	5.00
2100-1630	LT16R-30	4.52
2100-2204	LT22R-4B	6.44
2100-0904	R0903B	4.54
2100-1003	R1003B	4.52
2100-1204	R1203B	3.86
2100-0905	S0903B	2.56
2100-1205	S1203B	4.18
2100-1505	S1504B	3.90
2100-1906	S1904B	3.90

Item#	Style	Price (F)
2100-4200	SE1203X	4.52
2100-0903	SKCP-343	6.44
2100-1051	SM815.182	6.00
2100-1102	TP11D	5.38
2100-1100	TP16D	5.38
2100-1101	TP22D	6.96
2100-1603	T1603B	4.52
2100-2203	T2203B	5.74
2100-2703	T2703B	5.85
2100-2210	TNSN-2A	4.52
2100-2212	TNSN-3A-3	4.52
2100-2214	TNSN-3A	4.52
2109-1602	V1603B	4.52
2100-2202	V2203B	4.52
2109-0008	IVSN-322	5.00
2100-0603	W0603B	4.52
2100-0803	W0803	8.53
2109-0004	IWSN-322	5.00

*Limited Supply

SHIM PINS

Item#	Style	Price (F)
2100-0055	THT0505	4.38
2100-0056	THT0706	4.38
2100-0057	THT0907	4.38
2100-0058	THT1212	4.38



SPRINGS FOR INDEXABLE TOOLING

Item#	Style	Price (F)
2100-0100	MTH0610	3.46
2100-4380	YB5512	3.46
2100-4384	YB6512	3.46



LOCK PINS FOR INDEXABLE TOOLING METRIC THREAD

Item#	Style	Price (F)
2100-0800	M-ZX0410	4.00
2109-0014	NL-34L	4.00
2109-0010	NL-46L	4.00
2109-0016	NL-46L	4.00



Item#	Style	Price (F)
2100-0409	NL-0409	6.44
2100-0410	NL-0410	9.08
2100-0414*	NL-0414	9.08
2100-0611	NL-0611	9.08
2100-0412	NL-412	9.08
2100-0617*	NL-0617	9.08
2100-0822	NL-0822	9.04
2100-0823*	NL-0823	9.04

* Use a shim

TOOL HOLDER TECHNICAL INFORMATION

EXTERNAL TURNING TOOLHOLDERS IDENTIFICATION SYSTEM (INCH)

P	S	B	N	R	16		-	4	D
1	2	3	4	5	6	7		8	9

1	METHOD OF HOLDING
C	Top clamping
M	Top and hole clamping
P	Pin only
S	Screw clamping
T	Double clamping
W	Wedge clamping

2	INSERT SHAPE
C	
D	
K	
R	
S	
T	
V	
W	

3 TOOL STYLE OR LEAD ANGLE				
A	B	C	D	E
F	G	J	K	L
M	O	P	Q	R
S	T	U	V	W

6	SHANK SIZE
	For square shank, the number represents the of sixteenths (1/16) of width and height. 6=3/8" Square 8=1/2" Square 10=5/8" Square 12=3/4" Square 16=1" Square 20=1-1/4" Square 24=1-1/2" Square
	For rectangular shanks, the first digit represents the number of eights (1/8) of width and the second digit represents the number of quarters of height. 64=3/4" x 1" 85=1" x 1-1/4" 86=1" x 1-1/2"

8	INSERT SIZE (I.C.)
	Number of eights (1/8) of I.C. (Inscribed Circle) Insert less than 1/4" I.C. 5=5/32" 6=3/16" 7=7/32"
	Insert 1/4" I.C. and over (in) 2=1/4" 2.5=5/16" 3=3/8" 4=1/2" 5=5/8" 6=3/4"

4	INSERT CLEARANCE ANGLE
B	
C	
D	
E	
N	
P	

5	CUTTING DIRECTION
R	
N	
L	

7	ADDITIONAL CODES
	D=Extended+1mm E=Extended+2mm F=Neutral, no offset

9	HOLDER LENGTH		
Q	2"	B	4.5"
P	2.5"	C	5"
N	2.75"	D	6"
M	3"	E	7"
K	3.15"	F	8"
J	3.5"	G	10"
A	4"	H	12"

INSERT DESIGNATION - ANSI

SHAPE

A = K = R =
 B = L = S =
 C = M = T =
 D = O = V =
 E = P = W =
 H =

CLEARANCE

N = D =
 A = E =
 B = F =
 C = G =
 P =

I.C.

Number of 1/16's on inserts less than 1/4" I.C.
 Number of 1/8's on inserts 1/4" I.C. and over
 Rectangle and parallelogram inserts require two digits:
 -1st, Number of 1/8's in width
 -2nd, Number of 1/4's in length
 2 = 1/4" 5 = 5/8"
 3 = 3/8" 6 = 3/4"
 4 = 1/2" 8 = 1"

CORNER

0 = Sharp Corner 4 = 1/16" radius
 1 = 1/64" radius 6 = 3/32" radius
 2 = 1/32" radius 8 = 1/8" radius
 3 = 3/64" radius 12 = 3/16" radius
 A = Square w/45° chamfer
 D = Square w/30° chamfer
 E = Square w/15° chamfer
 K = Square w/15° double chamfer
 N = Truncated triangle insert
 P = Flattened corner triangle

C N M G . 4 3 2

TOLERANCE

d	m	t
A = ± .0010	± .0002	± .001
F = ± .0005	± .0002	± .001
C = ± .0010	± .0005	± .001
H = ± .0005	± .0005	± .001
E = ± .0010	± .0010	± .001
G = ± .0010	± .0010	± .005
**J = ± .002 to ± .006	± .0002	± .001
**K = ± .002 to ± .006	± .0005	± .001
**L = ± .002 to ± .006	± .0010	± .001
**M = ± .002 to ± .006	± .003 to ± .008	± .005
**N = ± .002 to ± .006	± .003 to ± .008	± .001
**U = ± .003 to ± .010	± .005 to ± .015	± .005

GEOMETRY

A = H = Q =
 B = J = R =
 C = *K = T =
 *D = *L = U =
 *E = M = W =
 F = N = X = Special Design
 G =

THICKNESS

Number of 1/32's on inserts less than 1/4" IC
 Number of 1/16's on inserts 1/4" IC and over
 1 = 1/16" 4 = 1/4"
 2 = 1/8" 5 = 5/16"
 3 = 3/16" 6 = 3/8"

Geometry:
 B, C, H, J - countersink is between 70-90 degrees.
 Q, T, U, W - countersink is between 40-60 degrees.
 * Smaller than 1/4" I.C.
 ** Exact tolerance is determined by the size of the insert.

INSERT DESIGNATION - ISO

SHAPE

A = K = R =
 B = L = S =
 C = M = T =
 D = O = V =
 E = P = W =
 H =

CLEARANCE

N = D =
 A = E =
 B = F =
 C = G =
 P =

LENGTH OF CUTTING EDGE

If less than 10 use 0 in first place.
 Example: 9.525 = 09

CORNER

00 = Round Insert 12 = 1.2mm
 00 = Sharp Corner 16 = 1.6mm
 02 = 0.2mm 24 = 2.4mm
 04 = 0.4mm 32 = 3.2mm
 08 = 0.8mm 40 = 4.0mm
 A = Square w/45° chamfer
 D = Square w/30° chamfer
 E = Square w/15° chamfer
 K = Square w/15° double chamfer
 N = Truncated triangle insert
 P = Flattened corner triangle

C N M G . 12 04 08

TOLERANCE

d	m	t
A = ± 0.025	± 0.005	± 0.025
F = ± 0.013	± 0.005	± 0.025
C = ± 0.025	± 0.013	± 0.025
H = ± 0.013	± 0.013	± 0.025
E = ± 0.025	± 0.025	± 0.025
G = ± 0.025	± 0.025	± 0.130
*J = ± 0.05 to ± 0.15	± 0.005	± 0.025
*K = ± 0.05 to ± 0.15	± 0.013	± 0.025
*L = ± 0.05 to ± 0.15	± 0.025	± 0.025
*M = ± 0.05 to ± 0.15	± 0.08 to ± 0.20	± 0.130
*N = ± 0.05 to ± 0.15	± 0.08 to ± 0.20	± 0.025
*U = ± 0.08 to ± 0.25	± 0.13 to ± 0.38	± 0.130

GEOMETRY

A = H = R =
 B = J = T =
 C = M = U =
 F = N = W =
 G = Q = X = Special Design

THICKNESS

If less than 10 use 0 in first place.
 Example: 3.18 = 03

Geometry:
 B, C, H, J - countersink is between 70-90 degrees.
 Q, T, U, W - countersink is between 40-60 degrees.
 * Exact tolerance is determined by the size of the insert.

GRADE COMPARISON

C-2	General purpose-for cast iron and non-ferrous materials.	XAB848	Comprised of thick TiCN and Al ₂ O ₃ coatings makes it suitable for finishing and semi-finishing at high speed. It upgrades abrasive resistance greatly on the premise of increasing toughness. The cutting speed can increase more than 25% and the life will be improved more than 30% at the same cutting speed.
C-5	For heavy roughing to semi finishing of all steels.	XAB849	Substrate with excellent wear-resistance, in combination with MT-TiCN, thick layer Al ₂ O ₃ TiN coating. It is an ideal grade for finishing steel, cast steel and stainless steel under high speed and dry machining.
C-6	Designed for heavy roughing to semi finishing of steels.	XAC849	CVD all round coated cemented carbide. Optimized for steel milling, but also a good solution for nodular cast iron. This grade provides good economy in medium to long series production.
BPG253-CVD	CVD coated universal grade is suitable for steel and cast steel continuous cutting and interrupted cutting, finishing to roughing.	XAC898	CVD coated grade, which is the combination of hard substrate and coating(thick Al ₂ O ₃ + thick TiCN), shows excellent wear resistance and impact resistance when machining nodular cast iron at high speed.
BPG20B-PVD	PVD coated micro-grain carbide to use for a variety of stainless steel finishing at medium to low cutting speed. Excellent edge strength and high surface quality, provides the perfect ride cutting. High thermal shock resistance. Suitable for light interrupted cuts.	XAF795	Unique grade material with near perfect wear resistance and high temperature resistance. The nc-TiAlN coating, ultrafine grain substrate, and unique surface treatment make this grade suitable for high precision cutting of "difficult to machine" materials, such as stainless steel, etc.
TiN Coated	For turning and milling carbon and alloy steels, tool steel and stainless steel. Provides longer life than uncoated grades. For high heat & wear resistance on alloys, stainless steel & ductile iron	XAF798	A combination of 2-4 um nc-TiAlN coating and ultrafine grain carbide substrate with high strength and toughness. Suitable for light to medium milling, and boring of all kinds of materials. Recommended for finish and semi-finish turning of stainless steel and roughing turning of high-temperature alloys of steel from finishing to roughing. Under the same cutting conditions, the cutting speed can be increased by more than 25%, while the tool life can be 30% longer under the same cutting speed.
XAB599	CVD all round coated cemented carbide. Optimized for medium to rough steel milling, but also a good solution for nodular cast iron.	XAF799	PVD TiN coated carbide grade with good toughness and wear resistance. It is good for threading and drilling (both peripheral and central inserts) low carbon steel, stainless steel and heat resistance for steel and cast irons.
XAB649	A secure all around CVD coated grade for high productive P30 applications. It is tough enough for the most difficult steel machining. Use in dry and wet machining and interruptions. A grade you can rely on when the going gets tough.	XAL649	Substrate with good toughness and strength, in combination with TiCN, thin layer Al ₂ O ₃ , TiN coating. It is a premium grade for semi-finishing to light roughing milling of stainless steel at continuous and intermittent milling conditions.
XAB698	Possesses an excellent thermal and chemical stability with an optimized combination of high performance Nano coating and a highly tough substrate of ultra fine grains aimed at materials hard to machine, such as stainless steel, heat resistant alloys, titanium alloys, high temperature alloys, etc. It is especially suitable for finishing and semi-finishing applications.	XAL749	A very all around CVD coated cemented carbide grade optimized for medium machining to roughing of stainless steel in both continuous and interrupted cuts. The grade has an excellent resistance to both thermal and mechanical shock.
XAB699	CVD all round coated cemented carbide. Optimized for steel milling, but also a good solution for nodular cast iron. This grade provides an economic solution in medium to long series production.	XC899	With fine size grain. Good for fine and semi-finishing machining of cast iron and nonferrous metal. Particularly for machining of aluminum.
XAB748	Comprising of thick TiCN and Al ₂ O ₃ coating has high anti-plastic yield and cutting edge strength and is the preferred universal grade from steel finishing to roughing. It behaves steady in wicked cutting conditions and can realizes environmental dry-cutting. The cutting speed can increase more than 25% at the same cutting condition and the life will be improved more than 30% at the same cutting speed.	XMF849	TiCN based cermet, with fine resistant thermoplastic transmutation and resistant built-up. It is suitable for semi-finishing and finishing of steel, stainless steel and cast iron.
XAB749	The cutting edge has special strength and toughness, in an optimal combination with MT-TiCN, thick layer Al ₂ O ₃ TiN coating. It is a suitable grade for a wide variety of applications. It is good for finishing, semi-finishing and light roughing of steel, cast steel, stainless steel and cast iron.		

CARBIDE GRADE INFORMATION/COMPARISON

GRADE	MITSUBISHI	SANDVIK	SECO	KENAMETAL	VALENITE	KORLOY	WALTER	TaeguTec
XAB849	UE6005/UE6010	GC4015	TX110	KC9110/KC935			WTL41/WTA33	
XAB848	F7010	GC4215	TX110	KC9010/KC910	SV305	NC310	WTA21	TT1500
XAB749	UC6010/EU6020	GC4020	TP200	KC725M/KC9125	SV410		WTA31/WXK15/WQM25/WTL82	TT3500
XAB748	UC6025/F620	GC4025	T250M/T25M	KC9040/KC625M	SV325	NC310	WAP20/WTN43	
XAB699	UP20M/AP20M	GC4030/GC4035	CP20TP200	KC850/CM4KC7025/KC7215	SV935	NC320/NC330	WXM15/WTA41	TT7200
XAB698								
XAB649	UE6035	GC4125	CP30	CD4/KC7020	SV330	NC320	WXP25/WTA61/WTL71/WTL14	
XAB599	UE6035	GC1120	TP40	CS3[KC7030]	SM245	NC330	WQM35/WTP30	TT8020
XAC849	UC6010/EU6020	GC3015/GC3115	TP100	KC625M/KC631M	SV305		WAK15	
XAF799	UP10H	GC1020/GC1120	TX150	KC992M/KC7215/KC9315/KC7225	SV415	NC315K	WAK20/WTA43/WTA33/WTA/41	
XAF798	AP20M	GC3040	F25M	KC9025/KC631M		NCM325	WXP20/WTP20	
XAF797								
XAF960	AP15TF	GC3040		CS3[KC7030]	SV515		WAP35	TT8020
XAL849		GC2015		KC510M			WAM10/WAP10	TT9030
XAL749	F620	GC2025	CP50	KC9225/KC7020	SV415	NC325S	WAM20/WTA43	TT5100
XAL748	F620	GC2025	CP50	KC9225/KC7020	SV415	NC325S	WAM20/WTA43	TT5100
XAL649	F730	GC2035	CP50	KC9040/KC7020		NCM335	WTP35/WTA51	TT8020
XB970R								
XMF849								

CHIP-BREAKER INFORMATION

Characteristics	Description
-DF	Recommended for finishing steel materials. With a satisfactory flow of chips and an excellent surface quality.
-DM	Recommended for semi-finishing steel materials. With a light cutting force and a wide range of chipping, it can achieve better results in machining alloyed steel with a high adhesiveness.
-DR	Recommended for quasi-roughing steel materials. It is the first option for roughing operations under general working conditions. It can achieve a high rate of metal removal and economy.
-EF	Recommended for finishing materials heat-resistant steel. A specially designed rake angle and an inclined edge angle aimed at machining highly adhesive and plastic material hard to machine, like stainless steel. The edges are sharp making the cutting light and smooth, getting a good control of the chips and obtaining an excellent surface quality, which makes it most suitable for ultra fine and fine machining of such materials.
-EM	Recommended for 300 series stainless steels. Impact resistance of the cutting edge is strengthened for interrupted cutting. The sharp cutting edges function to shear low machinability rated metals while resisting edge-build-up.
-HF	Recommended for finishing of universal applications. Suitable for finishing internal and peripheral operations in machining steel and cast iron. Fine finishing of surface can be achieved with a slow feed rate.
-HM	Recommended for semi-finishing of universal applications. With sharp wave cutting edges to reduce cutting force. Suitable for semi-finishing internal and peripheral operations of steel and cast iron. It is the first choice for semi-finishing of internal holes and allows chips to flow smoothly.
-HR	Recommended for roughing operations. With tough cutting edge. Suitable for internal and peripheral machining of steel, stainless steel and cast iron with irregular surface.
-LH	Recommended for aluminum alloy. Suitable machining aluminum alloy with larger cutting depth and higher feed rate.
-PF	Recommended for finishing steel materials. Suitable for finishing operations under unstable cutting conditions with a light cutting force.
-PM	Recommended for semi-finishing steel materials. With a stronger edge than -DM. Suitable for semi-finishing operations under unstable cutting conditions and for machining cast iron as well with a light cutting force.
-PR	Recommended for roughing of steel. With a high safety of cutting edges. It can achieve a high rate of metal removal with a low cutting force under working conditions of deep cuts and fast feed rates.

CARBIDE INSERTS

ANGX CARBIDE INSERTS

ANGX

- Double-sided insert provides 4-cutting edges, has a bigger depth of cut providing value and economy.
- High precision cutting edges are more aggressive & they have twice the cutting edges of APKT.
- Designed to improve shoulder milling surface finish.



10 PC PER PACKAGE

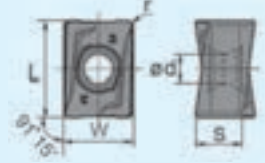

Item#	ANSI Insert No.	L	W	S	d	r	Grade	Price (F)
6064-0011	ANGX110508 PNR-GM	0.467"	0.331"	0.224"	0.138"	0.031"	XAF795	21.30
6064-0015	ANGX150608 PNR-GM	0.608"	0.433"	0.287"	0.173"	0.031"	XAF795	24.68

APKT-SQUARE SHOULDER MILLING CARBIDE INSERT (10MM) Positive Rake Angle

APKT

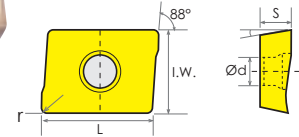

10 PC PER PACKAGE

Item#	ANSI Insert No.	I.W.	L	S	d	r	Grade	Price (E)
6010-4203	APKT-1003PDER	.265"	.441"	.137"	.110"	1/64"	XAF798	12.45

APKT/PF CARBIDE SHOULDER MILLING INSERTS (11MM, 16MM) 11° Relief Clearance

APKT-PF

PF - Excellent Surface Finishing

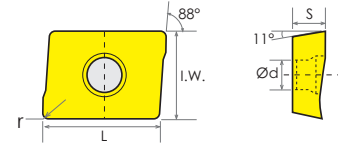

10 PC PER PACKAGE

Item#	ANSI Insert No.	I.W.	(Inch) L	S	d	r	Grade	Price (F)
6010-3002	APKT-11T304-PF	.256	.482	.142	.110	.0157	XAB699	13.71
6010-3312*	APKT-11T312-PF	.256	.482	.142	.110	.0472	XAF798	7.68

*Limited Supply

APKT/PM CARBIDE SHOULDER MILLING INSERTS (11MM, 16MM) 11° Relief Clearance

APKT-PM

PM - With stronger cutting edge, it is better for intermittent cutting than -DM, with wider cutting zone of steel materials.

PM - Suitable for Mixed Production

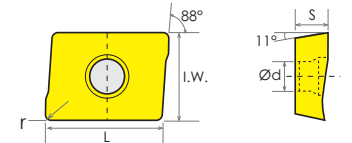

10 PC PER PACKAGE

Item#	ANSI Insert No.	I.W.	(Inch) L	S	d	r	Grade	Price (F)
6010-4002	APKT-11T304-PM	.256	.482	.142	.110	.0157	XAB699	13.71
6010-4308	APKT-11T308-PM	.256	.482	.142	.110	.0315	XAF798	13.71
6010-4608*	APKT-11T308-PM	.256	.482	.142	.110	.0315	XAL649	7.68
6010-4316*	APKT-11T316-PM	.256	.482	.142	.110	.0630	XAF798	9.77
6010-4003	APKT-160408-PM	.363	.704	.227	.173	.0315	XAB699	16.23

*Limited Supply

CCGX/LH CARBIDE INSERTS FOR ALUMINUM ALLOY

CCGX-LH

LH Chip-Breaker is more suitable for machining aluminum alloy with larger cutting depth and higher feed rate

Limited Supply!

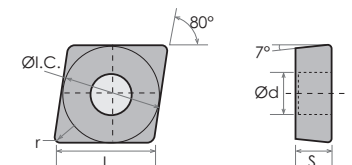

10 PC PER PACKAGE

Item#	ANSI Insert No.	ISO Insert No.	I.C.	L	(Inch) S	d	r	Grade	Price (F)
6054-0110	CCGX2(1.5)0-LH	CCGX060202-LH	1/4	.252	3/32	.110	.008	XC899	6.62
6054-0112	CCGX2(1.5)2-LH	CCGX060208-LH	1/4	.252	3/32	.110	.031	XC899	6.62
6054-0221	CCGX3(2.5)1-LH	CCGX09T304-LH	3/8	.382	5/32	.173	.016	XC899	6.86
6054-0222	CCGX3(2.5)2-LH	CCGX09T308-LH	3/8	.382	5/32	.173	.031	XC899	6.86
6054-0431	CCGX-431-LH	CCGX120404-LH	1/2	.508	3/16	.219	.016	XC899	7.35
6054-0432	CCGX-432-LH	CCGX120408-LH	1/2	.508	3/16	.219	.031	XC899	7.35

CCMT 80° DIAMOND - POSITIVE RAKE CARBIDE INSERTS

CCMT

- Use for turning.
- 7° relief angle.
- Single sided.
- Use for light cuts.

TiN(C-5) Coated

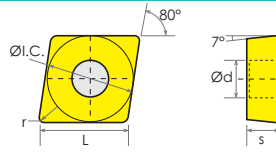

10 PC PER PACKAGE

Item#	ANSI Insert No.	ISO Insert No.	I.C.	L	(Inch) S	d	r	Grade	Price (F)
6003-2021	CCMT-21.51	CCMT060204	1/4	1/4	3/32	7/64	.0157	TiN(C5)	6.00
6003-2022	CCMT-21.52	CCMT060208	1/4	1/4	3/32	7/64	.0315	TiN(C5)	6.00
6003-2031	CCMT-32.50	CCMT09T302	3/8	3/8	5/32	0.17	.0157	TiN(C5)	7.18
6003-2032	CCMT-32.51	CCMT09T304	3/8	3/8	5/32	0.17	.0315	TiN(C5)	7.18

CCMT/EM 80° DIAMOND - POSITIVE RAKE CARBIDE INSERTS

CCMT-EM

EM - Semi-Finishing Geometry. Stainless Steel Material

EM -Single-side chipbreaker with M-class tolerance serves to reduce cutting force and workpiece adhesion when machining stainless steel. Possesses higher feed and depth of cut capability than EF chipbreaker.

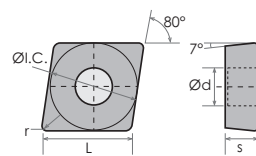
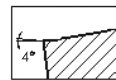

10 PC PER PACKAGE

Item#	ANSI Insert No.	ISO Insert No.	I.C.	L	(Inch) S	d	r	Grade	Price (F)
6053-0111	CCMT-21.51-EM	CCMT060204EM	1/4	1/4	3/32	7/64	.0157	XAF798	7.11
6053-0112	CCMT-21.52-EM	CCMT060208EM	1/4	1/4	3/32	7/64	.0315	XAF798	7.11
6053-0221	CCMT-32.51-EM	CCMT09T304EM	3/8	3/8	5/32	0.17	.0157	XAF798	8.25
6053-0222	CCMT-32.52-EM	CCMT09T308EM	3/8	3/8	5/32	0.17	.0315	XAF798	8.25
6053-0432*	CCMT-432-EM	CCMT120408EM	1/2	1/2	3/16	7/32	.0315	XAF798	10.98

*Limited Supply

CCMT/HM 80° DIAMOND-POSITIVE RAKE CARBIDE INSERTS

CCMT-HM

HM - Medium Geometry. Periphery Ground Insert. Mixed Production

HM - With a sharp wave cutting edge to reduce cutting force, it is the first choice for semi-finishing of internal holes and allows chips to flow smoothly.

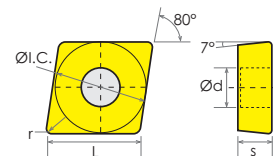

10 PC PER PACKAGE

Item#	ANSI Insert No.	ISO Insert No.	I.C.	L	(Inch) S	d	r	Grade	Price (F)
6003-5021	CCMT-21.51-HM	CCMT060204HM	1/4	1/4	3/32	7/64	.0157	XAB749	7.11
6003-5022*	CCMT-21.52-HM	CCMT060208HM	1/4	1/4	3/32	7/64	.0315	XAB749	5.08
6003-5031	CCMT-32.51-HM	CCMT09T304HM	3/8	3/8	5/32	0.17	.0157	XAB749	8.25
6003-5032	CCMT-32.52-HM	CCMT09T308HM	3/8	3/8	5/32	0.17	.0315	XAB749	8.25
6003-5431*	CCMT-431-HM	CCMT120404HM	1/2	1/2	3/16	7/32	.0157	XAB749	6.73
6003-5432*	CCMT-432-HM	CCMT120408HM	1/2	1/2	3/16	7/32	.0315	XAB749	7.81
6003-5433*	CCMT-433-HM	CCMT120412HM	1/2	1/2	3/16	7/32	.0472	XAB749	6.73

*Limited Supply

CNMA DIAMOND-NEGATIVE RAKE CARBIDE INSERTS

CNMA

- Use for turning & boring
- 0° relief angle.
- No chipbreaker.
- 80° diamond negative rake.

Limited Supply!

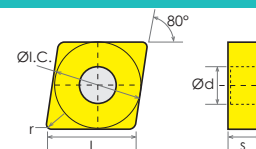
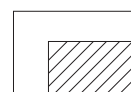

10 PC PER PACKAGE

Item#	ANSI Insert No.	ISO Insert No.	I.C.	L	(Inch) S	d	r	Grade	Price (F)
6000-6431	CNMA-431	CNMA120404	1/2	1/2	3/16	13/64"	.0157	XAC849	5.32
6000-6432	CNMA-432	CNMA120408	1/2	1/2	3/16	13/64	.0315	XAC849	5.32
6000-6433	CNMA-433	CNMA120412	1/2	1/2	3/16	13/64	.0472	XAC849	5.32
6000-6543	CNMA-543	CNMA160612	5/8	5/8	1/4	1/4	.0472	XAC849	8.42
6000-6643	CNMA-643	CNMA190612	3/4	3/4	1/4	5/16	.0472	XAC849	10.81
6000-6644	CNMA-644	CNMA190616	3/4	3/4	1/4	5/16	.0630	XAC849	10.81

Carbide grades and insert classification shown on pages 167-170

CARBIDE INSERTS

CNMG TiN (C5) DIAMOND-NEGATIVE RAKE CARBIDE INSERTS

CCMT

- Use for turning & boring
- 0° relief angle.
- Chipbreaker two sides.
- 80° diamond negative rake.

TiN(C-5) COATED

Limited Supply!

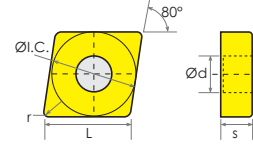
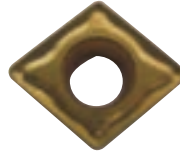

10 PC PER PACKAGE

Item#	ANSI Insert No.	ISO Insert No.	I.C.	L	(Inch) S	d	r	Grade	Price (F)
6000-6831	CNMG-431	CNMG120404	1/2	1/2	3/16	13/64"	.0157	TiN(C5)	7.56
6000-6832	CNMG-432	CNMG120408	1/2	1/2	3/16	13/64	.0315	TiN(C5)	7.26
6000-6943	CNMG-643	CNMG190612	3/4	3/4	1/4	5/16	.0472	TiN(C5)	15.73

CNMG/DF DIAMOND-NEGATIVE RAKE CARBIDE INSERTS

CNMG-DF

DF-For Steel Finishing

DF-Chip-breaker with special angle design allows for easy cuttings, controls chip flow and provides good surface finish

Limited Supply!

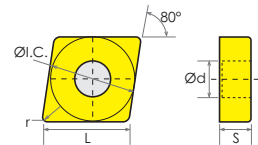
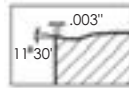

10 PC PER PACKAGE

Item#	ANSI Insert No.	ISO Insert No.	I.C.	L	(Inch) S	d	r	Grade	Price (F)
6000-1431	CNMG-431-DF	CNMG120404DF	1/2	1/2	3/16	13/64	.0157	XAB849	10.02
6000-1432	CNMG-432-DF	CNMG120408DF	1/2	1/2	3/16	13/64	.0315	XAB849	10.02
6000-1433	CNMG-433-DF	CNMG120412DF	1/2	1/2	3/16	13/64	.0472	XAB849	6.16

CNMG/DM DIAMOND-NEGATIVE RAKE CARBIDE INSERTS

CNMG-DM

DM - For Steel Medium Machining

DM - Widely used chipbreaker is used for semi-finishing and finishing of steel and stainless steel.

Limited Supply!

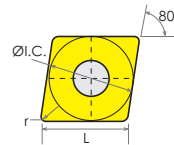
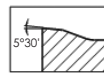

10 PC PER PACKAGE

Item#	ANSI Insert No.	ISO Insert No.	I.C.	L	(Inch) S	d	r	Grade	Price (F)
6000-2431	CNMG-431-DM	CNMG120404DM	1/2	1/2	3/16	13/64	.0157	XAB749	7.13
6000-2432	CNMG-432-DM	CNMG120408DM	1/2	1/2	3/16	13/64	.0315	XAB749	7.13
6000-2433	CNMG-433-DM	CNMG120412DM	1/2	1/2	3/16	13/64	.0472	XAB749	6.16
6000-2542	CNMG-542-DM	CNMG160608DM	5/8	5/8	1/4	1/4	.0315	XAB749	9.75
6000-2543	CNMG-543-DM	CNMG160612DM	5/8	5/8	1/4	1/4	.0472	XAB749	9.71
6000-2643	CNMG-643-DM	CNMG190612DM	3/4	3/4	1/4	5/16	.0472	XAB749	12.52

CNMG/DM DIAMOND-NEGATIVE RAKE CERMET INSERTS

CNMG-DM

DM - For Steel Medium Machining

DM - Widely used chipbreaker is used for semi-finishing and finishing of steel and stainless steel.

Limited Supply!

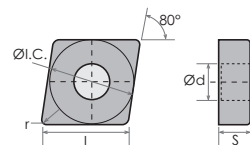
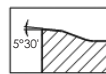

10 PC PER PACKAGE

Item#	ANSI Insert No.	ISO Insert No.	I.C.	L	(Inch) S	d	r	Cermet Grade	Price (F)
6000-5431	CNMG-431-DM	CNMG120404DM	1/2	1/2	3/16	13/64	.0157	XMF849	5.96
6000-5432	CNMG-432-DM	CNMG120408DM	1/2	1/2	3/16	13/64	.0315	XMF849	5.96

CNMG/DM -BLACK-DIAMOND COATED CARBIDE INSERTS

CNMG-DM

DM - For Steel Medium Machining

DM - Widely used chipbreaker is used for semi-finishing and finishing of steel and stainless steel.

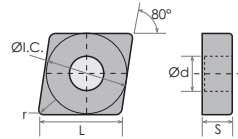
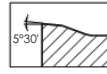

10 PC PER PACKAGE

TICN & Al₂O₃ COATED

Item#	ANSI Insert No.	ISO Insert No.	I.C.	L	(Inch) S	d	r	Grade	Price (F)
6030-2431	CNMG-431-DM	CNMG120404DM	1/2	1/2	3/16	13/64	.0157	XAB748	10.02
6030-2432	CNMG-432-DM	CNMG120408DM	1/2	1/2	3/16	13/64	.0315	XAB748	10.02
6030-2433	CNMG-433-DM	CNMG120412DM	1/2	1/2	3/16	13/64	.0472	XAB748	10.02
6030-2542*	CNMG-542-DM	CNMG160608DM	5/8	5/8	1/4	1/4	.0315	XAB748	9.75
6030-2543*	CNMG-543-DM	CNMG160612DM	5/8	5/8	1/4	1/4	.0472	XAB748	9.75
6030-2643*	CNMG-643-DM	CNMG190612DM	3/4	3/4	1/4	5/16	.0472	XAB748	12.52

*Limited Supply

CNMG/DR DIAMOND - NEGATIVE RAKE CARBIDE INSERTS

CNMG-DR

DR- For Light Roughing of Steel, Stainless Steel Material

DR - Single-side chipbreaker with M-class tolerance has high security on cutting edge for higher removal rates and low cutting force at large cutting depth and high feed rates.

Limited Supply!

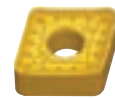
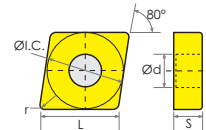
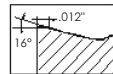

10 PC PER PACKAGE

Item#	ANSI Insert No.	ISO Insert No.	I.C.	L	(Inch) S	d	r	Grade	Price (F)
6048-0433	CNMG-433-DR	CNMG120412DR	1/2	1/2	3/16	13/64	.0472	XAB748	5.35
6048-0543	CNMG-543-DR	CNMG160612DR	5/8	5/8	1/4	1/4	.0472	XAB748	8.43
6048-0544	CNMG-544-DR	CNMG160616DR	5/8	5/8	1/4	1/4	.0630	XAB748	8.43
6048-0643	CNMG-643-DR	CNMG190612DR	3/4	3/4	1/4	5/16	.0472	XAB748	10.84
6048-0644	CNMG-644-DR	CNMG190616DR	3/4	3/4	1/4	5/16	.0630	XAB748	10.84

CNMG/EF-CARBIDE INSERTS

CNMG-EF

EF - For Stainless Steel, Highly Adhesive and Plastic Materials

EF Chip-Breaker specially designed rake angle and an inclined edge angle for machining stainless steel. The edges are sharp making the cutting light and smooth, getting a good control of the chips and obtaining a good surface quality, which makes it most suitable for ultra fine and fine machining of highly adhesive and plastic materials.

Limited Supply!

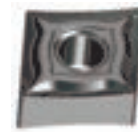
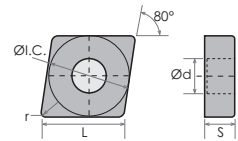

10 PC PER PACKAGE

Item#	ANSI Insert No.	ISO Insert No.	I.C.	L	(Inch) S	d	r	Grade	Price (F)
6030-5431	CNMG-431-EF	CNMG120404EF	1/2	1/2	3/16	13/64	.0157	XAF795	6.16
6030-5432	CNMG-432-EF	CNMG120408EF	1/2	1/2	3/16	13/64	.0315	XAF795	7.35
6030-5433	CNMG-433-EF	CNMG120412EF	1/2	1/2	3/16	13/64	.0472	XAF795	6.16

CNMG/PM DIAMOND-NEGATIVE RAKE CARBIDE INSERTS

CNMG-PM

PM - Suitable for Mixed Production

PM - With stronger cutting edge, it is better for intermittent cutting than -DM, with wider cutting zone of steel materials

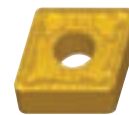
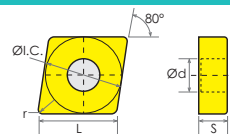

10 PC PER PACKAGE

Item#	ANSI Insert No.	ISO Insert No.	I.C.	L	(Inch) S	d	r	Grade	Price (F)
6000-3431	CNMG-431-PM	CNMG120404PM	1/2	1/2	3/16	13/64	.0157	XAB749	8.67
6000-3432	CNMG-432-PM	CNMG120408PM	1/2	1/2	3/16	13/64	.0315	XAB749	8.67
6000-3433*	CNMG-433-PM	CNMG120412PM	1/2	1/2	3/16	13/64	.0472	XAB749	6.16
6000-3542*	CNMG-542-PM	CNMG160608PM	5/8	5/8	1/4	1/4	.0315	XAB749	9.75
6000-3543*	CNMG-543-PM	CNMG160612PM	5/8	5/8	1/4	1/4	.0472	XAB749	11.24
6000-3642*	CNMG-642-PM	CNMG190608PM	3/4	3/4	1/4	5/16	.0315	XAB749	12.52
6000-3643*	CNMG-643-PM	CNMG190612PM	3/4	3/4	1/4	5/16	.0472	XAB749	12.52

*Limited Supply

CNMM/DR DIAMOND-NEGATIVE RAKE CARBIDE INSERTS

CNMM-DR

DR - For Light Roughing of Steel

DR - Special chip-breaker with high toughness cutting edge can reduce cutting force

Limited Supply!

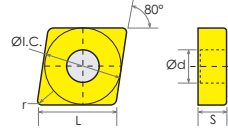
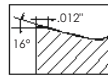

10 PC PER PACKAGE

Item#	ANSI Insert No.	ISO Insert No.	I.C.	L	(Inch) S	d	r	Grade	Price (F)
6001-2432	CNMM-432-DR	CNMM120408HDR	1/2	1/2	3/16	13/64	.0315	XAB749	5.32
6001-2433	CNMM-433-DR	CNMM120412DR	1/2	1/2	3/16	13/64	.0472	XAB749	5.32
6001-2543	CNMM-543-DR	CNMM160612DR	5/8	5/8	1/4	1/4	.0472	XAB749	8.42
6001-2544	CNMM-544-DR	CNMM160616DR	5/8	5/8	1/4	1/4	.0630	XAB749	8.42
6001-2643	CNMM-643-DR	CNMM190612DR	3/4	3/4	1/4	5/16	.0472	XAB749	10.81
6001-2644	CNMM-644-DR	CNMM190616DR	3/4	3/4	1/4	5/16	.0630	XAB749	10.81

CPMT 80° BLACK-DIAMOND COATED - POSITIVE RAKE CARBIDE INSERTS

CPMT

- Use for boring & facing.
- 11° relief angle.
- Single sided with chip control.

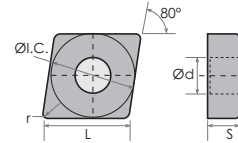
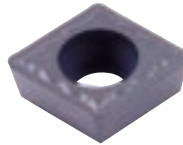

10 PC PER PACKAGE

Item#	ANSI Insert No.	ISO Insert No.	I.C.	L	(Inch) S	d	r	Grade	Price (F)
6060-0211	CPMT-21.51	CPMT060204	1/4	1/4	3/32	7/64	.0157	XAC898	6.97
6060-0322	CPMT-32.52	CPMT09T308	3/8	3/8	5/32	0.17	.0315	XAC898	9.27
6060-0431	CPMT-432	CPMT120408	1/2	1/2	3/16	0.217	.0315	XAC898	9.80

DCGX/LH CARBIDE INSERTS FOR ALUMINUM ALLOY

DCGX-LH

LH Chip-Breaker is more suitable for machining aluminum alloy with larger cutting depth and higher feed rate

Limited Supply!

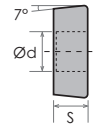
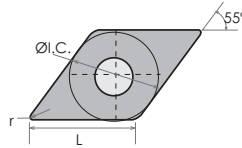

10 PC PER PACKAGE

Item#	ANSI Insert No.	ISO Insert No.	I.C.	L	(Inch) S	d	r	Grade	Price (F)
6055-0110	DCGX2(1.5)0-LH	DCGX070202-LH	1/4	.307	3/32	.110	.008	XC899	7.52
6055-0111	DCGX2(1.5)1-LH	DCGX070204-LH	1/4	.307	3/32	.110	.016	XC899	6.34
6055-0221	DCGX3(2.5)1-LH	DCGX11T304-LH	3/8	.457	5/32	.173	.016	XC899	6.95
6055-0222	DCGX3(2.5)2-LH	DCGX11T308-LH	3/8	.457	5/32	.173	.031	XC899	6.95

DCMT/EM 55° DIAMOND - POSITIVE RAKE CARBIDE INSERTS

DCMT-EM

EM - Semi-Finishing Geometry. Stainless Steel Material

EM - Single-side chipbreaker with M-class tolerance serves to reduce cutting force and workpiece adhesion when machining stainless steel. Possesses higher feed and depth of cut capability than EF chipbreaker.

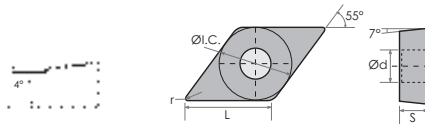

10 PC PER PACKAGE

Item#	ANSI Insert No.	ISO Insert No.	I.C.	L	(Inch) S	d	r	Grade	Price (F)
6004-1021	DCMT-21.51-EM	DCMT070204EM	1/4	0.307	3/32	7/64	.0157	XAF798	6.75
6004-1022*	DCMT-21.52-EM	DCMT070208EM	1/4	0.307	3/32	7/64	.0315	XAF798	6.72
6004-1031*	DCMT-32.51-EM	DCMT11T304EM	3/8	29/64	5/32	0.17	.0157	XAF798	9.18
6004-1032	DCMT-32.52-EM	DCMT11T308EM	3/8	29/64	5/32	0.17	.0315	XAF798	9.18

*Limited Supply

DCMT/HF 55° DIAMOND-POSITIVE RAKE CERMET INSERTS

DCMT-HF

HF - With sharp cutting edge, used for finishing internal holes, fine finishing of surface can be achieved with a slow feed rate.

HF - Finishing Geometry. Mixed Production

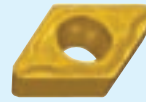
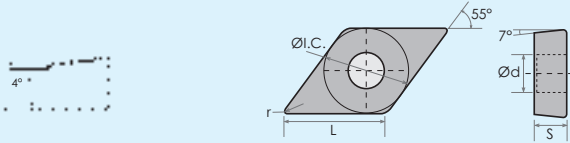

Limited Supply!

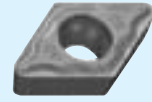

10 P.C.
PER
PACKAGE

ANSI Insert No.	ISO Insert No.	I.C.	L	(Inch) S	d	r	Item#	Cermet Grade	Price (F)
DCMT-32.50-HF	DCMT11T302HF	3/8	29/64	5/32	0.17	.0080	6003-8030	XMF849	6.56
DCMT-32.52-HF	DCMT11T308HF	3/8	29/64	5/32	0.17	.0315	6003-8032	XMF849	5.41

DCMT/HM 55° DIAMOND-POSITIVE RAKE CARBIDE INSERTS

DCMT-HM

HM - Medium Geometry. Periphery Ground Insert. Mixed Production

HM - With sharp wave cutting edge to reduce cutting force, it is the first choice for semi-finishing of internal holes and allows chips to flow smoothly.

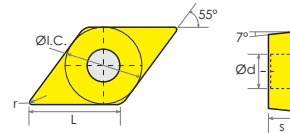
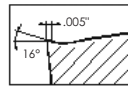

10 P.C.
PER
PACKAGE

Item#	ANSI Insert No.	ISO Insert No.	I.C.	L	(Inch) S	d	r	Grade	Price (F)
6004-0021	DCMT-21.51-HM	DCMT070204HM	1/4	0.307	3/32	7/64	.0157	XAB749	6.72
6004-0031	DCMT-32.51-HM	DCMT11T304HM	3/8	29/64	5/32	0.17	.0157	XAB749	9.18
6004-0032*	DCMT-32.52-HM	DCMT11T308HM	3/8	29/64	5/32	0.17	.0315	XAB749	9.18
6004-0033*	DCMT-32.53-HM	DCMT11T312HM	3/8	29/64	5/32	0.17	.0472	XAB749	5.68

*Limited Supply

DNMA 55° DIAMOND-NEGATIVE RAKE CARBIDE INSERTS

DNMA

• 55° diamond for profiling.

Limited Supply!

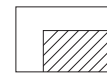
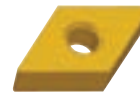
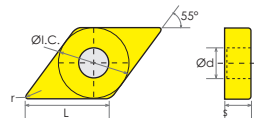

10 P.C.
PER
PACKAGE

Item#	ANSI Insert No.	ISO Insert No.	I.C.	L	(Inch) S	d	r	Grade	Price (F)
6001-3442	DNMA-442	DNMA150608	1/2	39/64	1/4	13/64	.0315	XAC849	7.26
6001-3443	DNMA-443	DNMA150612	1/2	39/64	1/4	13/64	.0472	XAC849	7.26
6001-3444	DNMA-444	DNMA150616	1/2	39/64	1/4	13/64	.0630	XAC849	7.26

DNMG/DF 55° DIAMOND-NEGATIVE RAKE CARBIDE INSERTS

DNMG-DF

DF - For Steel Finishing

DF-Chip-breaker with special angle design allows for easy cuttings, controls chip flow and provides good surface finish

Limited Supply!

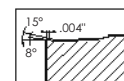
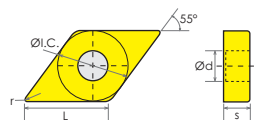

10 P.C.
PER
PACKAGE

Item#	ANSI Insert No.	ISO Insert No.	I.C.	L	(Inch) S	d	r	Grade	Price (F)
6000-7331	DNMG-331-DF	DNMG110404DF	3/8	29/64	3/16	0.15	.0157	XAB749	6.86
6000-7332	DNMG-332-DF	DNMG110408DF	3/8	29/64	3/16	0.15	.0315	XAB749	5.93
6000-7333	DNMG-333-DF	DNMG110412DF	3/8	29/64	3/16	0.15	.0472	XAB749	3.82
6000-7431	DNMG-431-DF	DNMG150404DF	1/2	39/64	3/16	13/64	.0157	XAB749	8.16
6000-7432	DNMG-432-DF	DNMG150408DF	1/2	39/64	3/16	13/64	.0315	XAB749	7.05

CARBIDE INSERTS

DNMG/DF 55° -BLACK-DIAMOND COATED CARBIDE INSERTS

DNMG-DF

DF - For Steel Finishing

TiCN & Al₂O₃ COATED

Limited Supply!

DF-Chip-breaker with special angle design allows for easy cuttings, controls chip flow and provides good surface finish

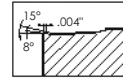
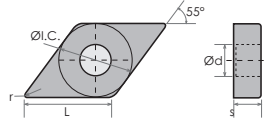

10 PC PER PACKAGE

Item#	ANSI Insert No.	ISO Insert No.	I.C.	L	(Inch) S	d	r	Grade	Price (F)
6033-0331	DNMG-331-DF	DNMG110404DF	3/8	29/64	3/16	0.15	.0157	XAB848	6.86
6033-0332	DNMG-332-DF	DNMG110408DF	3/8	29/64	3/16	0.15	.0315	XAB848	7.90
6033-0432	DNMG-432-DF	DNMG150408DF	1/2	39/64	3/16	13/64	.0315	XAB848	8.16

DNMG/DM 55° DIAMOND-NEGATIVE RAKE INSERTS

DNMG-DM

DM - Widely used chip-breaker is used for semi-finishing and finishing of steel and stainless steel

DM - For Steel Medium Machining

Black-Diamond: TiCN & Al₂O₃ COATED

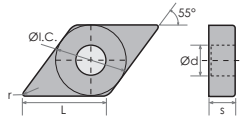
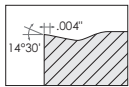

10 PC PER PACKAGE

ANSI Insert No.	ISO Insert No.	I.C.	L	(Inch) S	d	r	Carbide Item#	Carbide Grade	Carbide Price (F)	Cermet Item#	Cermet Grade	Cermet Price (F)	Black-Diamond Item#	Black-Diamond Grade	Black-Diamond Price (F)
DNMG-331-DM	DNMG110404DM	3/8	29/64	3/16	0.15	.0157	6000-8331*	XAB749	5.93	-----	-----	-----	6033-1331	XAB748	9.66
DNMG-332-DM	DNMG110408DM	3/8	29/64	3/16	0.15	.0315	6000-8332*	XAB749	5.93	-----	-----	-----	6033-1332	XAB748	9.66
DNMG-431-DM	DNMG150404DM	1/2	39/64	3/16	13/64	.0157	-----	-----	-----	6001-1431*	XMF849	8.16	6033-1431*	XAB748	8.16
DNMG-432-DM	DNMG150408DM	1/2	39/64	3/16	13/64	.0315	6000-8432*	XAB749	7.05	6001-1432*	XMF849	7.92	6033-1432	XAB748	13.29
DNMG-433-DM	DNMG150412DM	1/2	39/64	3/16	13/64	.0472	6000-8433*	XAB749	7.05	-----	-----	-----	6033-1433*	XAB748	8.16

*Limited Supply

DNMG/DR 55° BLACK-DIAMOND - NEGATIVE RAKE CARBIDE INSERTS

DNMG-DR

DR - For Light Roughing of Steel, Stainless Steel Material

Black-Diamond: TiCN & Al₂O₃ COATED

DR - Single-side chipbreaker with M-class tolerance has high security on cutting edge for higher removal rates and low cutting force at large cutting depth and high feed rates.

Limited Supply!

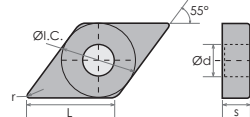
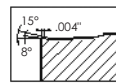

10 PC PER PACKAGE

Item#	ANSI Insert No.	ISO Insert No.	I.C.	L	(Inch) S	d	r	Grade	Price (F)
6046-0433	DNMG-433-DR	DNMG150412DR	1/2	39/64	3/16	13/64	.0472	XAB748	9.46
6046-0443	DNMG443-DR	DNMG150612DR	1/2	39/64	13/64	0.17	.0472	XAB748	10.32

DNMG/EF 55° - CARBIDE INSERTS

DNMG-EF

EF - For Stainless Steel, Highly Adhesive and Plastic Materials

Limited Supply!

EF Chip-Breaker specially designed rake angle and an inclined edge angle for machining stainless steel. The edges are sharp making the cutting light and smooth, getting a good control of the chips and obtaining a good surface quality, which makes it most suitable for ultra fine and fine machining of highly adhesive and plastic materials.

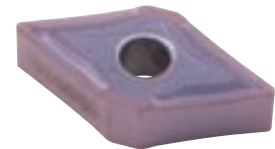
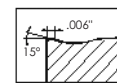
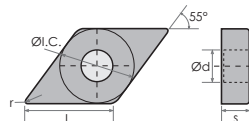

10 PC PER PACKAGE

Item#	ANSI Insert No.	ISO Insert No.	I.C.	L	(Inch) S	d	r	Grade	Price (F)
6033-5331	DNMG-331-EF	DNMG110404EF	3/8	29/64	3/16	0.15	.0157	XAF795	6.86
6033-5332	DNMG-332-EF	DNMG110408EF	3/8	29/64	3/16	0.15	.0315	XAF795	6.86
6033-5431	DNMG-431-EF	DNMG150404EF	1/2	39/64	3/16	13/64	.0157	XAF795	8.16
6033-5432	DNMG-432-EF	DNMG150408EF	1/2	39/64	3/16	13/64	.0315	XAF795	8.16

DNMG/PM 55° DIAMOND-NEGATIVE RAKE CARBIDE INSERTS

DNMG-PM

PM-Suitable for Mixed Production

PM - With stronger cutting edge, it is better for intermittent cutting than -DM, with wider cutting zone of steel materials

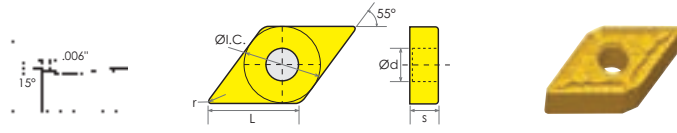

10 PC PER PACKAGE

Item#	ANSI Insert No.	ISO Insert No.	I.C.	L	(Inch) S	d	r	Grade	Price (F)
6000-9331*	DNMG-331-PM	DNMG110404PM	3/8	29/64	3/16	0.15	.0157	XAB749	6.86
6000-9332	DNMG-332-PM	DNMG110408PM	3/8	29/64	3/16	0.15	.0315	XAB749	9.66
6000-9333*	DNMG-333-PM	DNMG110412PM	3/8	29/64	3/16	0.15	.0472	XAB749	3.82
6000-9432	DNMG-432-PM	DNMG150408PM	1/2	39/64	3/16	13/64	.0315	XAB749	13.29
6000-9433*	DNMG-433-PM	DNMG150412PM	1/2	39/64	3/16	13/64	.0472	XAB749	11.46
6000-9434*	DNMG-434-PM	DNMG150416PM	1/2	39/64	3/16	13/64	.0630	XAB749	8.16
6000-9443*	DNMG-443-PM	DNMG150612PM	1/2	39/64	3/16	0.17	.0472	XAB749	9.37

*Limited Supply

DPMT CARBIDE INSERTS, 11° Relief

DPMT

Item#	ANSI No.	I.C.	r	Price (E)
6027-2151*	DPMT-21.51	1/4"	.0157"	6.32
6027-3252	DPMT-32.52	3/8"	.0315"	10.13

*Limited Supply

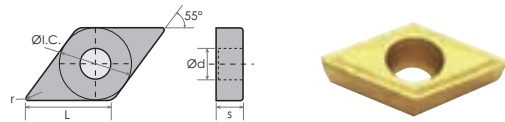

10 PC PER PACKAGE

KNUX PROFILE CARBIDE INSERTS

KNUX

- Turning insert.
- Parallelogram insert for profiling.
- Clamp on style.
- Negative along cutting edge and positive flank along the narrow edge.

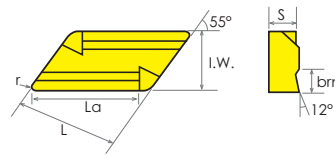

Limited Supply!

10 PC PER PACKAGE

Item#	ANSI Insert No.	La	L	I.W.	(Inch) S	bm	r	Grade	Price (F)
6005-4005	KNUX-160405L11	5/8	5/8	3/8	3/16	.0087	0.02	XAB749	5.95
6005-4010	KNUX-160410L11	5/8	5/8	3/8	3/16	.0087	0.04	XAB749	5.95
6005-4105	KNUX-160405L12	5/8	5/8	3/8	3/16	.0126	0.02	XAB749	5.95
6005-4110	KNUX-160410L12	5/8	5/8	3/8	3/16	.0126	0.04	XAB749	5.95
6005-4205	KNUX-160405R11	5/8	5/8	3/8	3/16	.0087	0.02	XAB749	5.95
6005-4210	KNUX-160410R11	5/8	5/8	3/8	3/16	.0087	0.04	XAB749	5.95
6005-4305	KNUX-160405R12	5/8	5/8	3/8	3/16	.0126	0.02	XAB749	5.95
6005-4310	KNUX-160410R12	5/8	5/8	3/8	3/16	.0126	0.04	XAB749	5.95

RCKT/DM CARBIDE FACE MILL INSERTS

RCKT-DM

7° Positive Relief Angle - For Turning & Facing

DM - Widely used chip-breaker is used for semi-finishing and finishing of steel and stainless steel

Item#	ANSI Insert No.	I.C.	Thickness	Hole	Grade	Price (F)
6034-1204	RCKT1204MO-DM	0.472"	3/16"	0.157"	XAF798	9.33

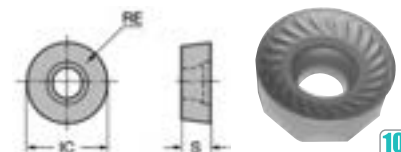

10 PC PER PACKAGE

RCKT/DR CARBIDE FACE MILL INSERTS

RCKT-DR

7° Positive Relief Angle - For Turning & Facing

DR - Used for roughing of material. It can achieve a high rate of metal removal & a low cutting force.

Item#	ANSI Insert No.	I.C.	Thickness	Hole	Grade	Price (F)
6034-2204	RCKT1204MO-DR	0.472"	3/16"	0.157"	XAL649	9.33
6034-2607*	RCKT2006MO-DR	0.787"	1/4"	0.258"	XAL649	10.98



10 PC PER PACKAGE

*Limited Supply

CARBIDE INSERTS

RCMT CARBIDE INSERTS

RCMT

7° Positive Relief Angle - For Turning & Facing

10 PC PER PACKAGE

ANSI Insert No.	I.C.	(Inch) Thickness	Hole	Grade C-2		TiN Coated (C-6)	
				Item#	Price (F)	Item#	Price (F)
RCMT-0602	.236	.0940	.110	6034-3012	6.18	6034-3062	5.08
RCMT-0803	.315	.1250	.134	6034-3013*	4.14	6034-3083	6.18
RCMT-10T3	.393	.1563	.173	6034-3023	5.89	6034-3103	6.67
RCMT-32	3/8	1/8	.150	6034-3032*	4.18	6034-3132	10.78
RCMT-1204	.472	.1870	.157	-----		6034-3124	7.43
RCMT-43	.500	3/16	.217	6034-3043*	5.23	-----	

*Limited Supply



RDKW CARBIDE INSERTS

RDKW

15° Relief Angle

10 PC PER PACKAGE

Item#	ANSI Insert No.	Nose Radius	I.C.	(Inch) Thickness	Hole	Grade	Price (F)
6045-0803*	RDKW0803MO	.157	.315	.125	0.134	XAF798	4.99
6045-1003*	RDKW10T3MO	.197	.394	.156	0.173	XAF798	5.28
6045-1204	RDKW1204MO	.236	.472	.186	0.173	XAF798	9.00

*Limited Supply



RNMG CARBIDE FACE MILL INSERTS

RNMG

0° Relief Angle - For Turning, Plunging & Profiling

Limited Supply!

10 PC PER PACKAGE

ANSI Insert No.	ISO Insert No.	I.C.	(Inch) Thickness	Hole	Grade C-2		TiN Coated (C5)	
					Item#	Price (F)	Item#	Price (F)
RNMG-32	RNMG0903	3/8	1/8	.150	6005-6030	4.05	-----	
RNMG-43MO	RNMG-1204MO	0.472	3/16	.157	-----		6005-5204	6.64
RNMG-43	RNMG1204	0.500	3/16	.203	6005-6043	3.63	6005-6143	6.40
RNMG-64	RNMG1906	0.750	1/4	.312	-----		6005-6164	14.48

*Limited Supply

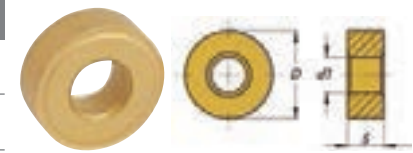

SCMT CARBIDE INSERTS

SCMT

7° Relief Angle-Single Sided

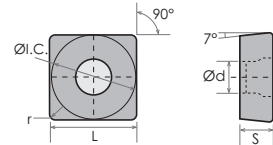

10 PC PER PACKAGE

Item#	ANSI Insert No.	ISO Insert No.	I.C.	L	(Inch) S	d	r	Grade	Price (F)
6004-4431*	SCMT-431	SCMT120404	1/2	1/2	3/16	7/32	.0157	C-6	5.81
6004-4432	SCMT-432	SCMT120408	1/2	1/2	3/16	7/32	.0315	C-6	5.78

*Limited Supply

SCMT/EM SQUARE - POSITIVE RAKE CARBIDE INSERTS

SCMT-EM

EM - Semi-Finishing Geometry. Stainless Steel Material

EM - Double-side chipbreaker with M-class tolerance serves to reduce cutting force and workpiece adhesion when machining stainless steel. Possesses higher feed and depth of cut capability than EF chipbreaker.

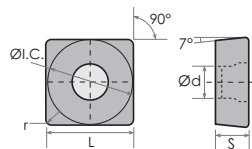

10 PC PER PACKAGE

Item#	ANSI Insert No.	ISO Insert No.	I.C.	L	(Inch) S	d	r	Grade	Price (F)
6056-0221*	SCMT32.51-EM	SCMT09T304EM	3/8	3/8	5/32	0.17	.0157	XAF798	6.18
6056-0431	SCMT-431-EM	SCMT120404EM	1/2	1/2	3/16	7/32	.0157	XAF798	10.98
6056-0432	SCMT-432-EM	SCMT120408EM	1/2	1/2	3/16	7/32	.0315	XAF798	10.98

*Limited Supply

SCMT/HM SQUARE - POSITIVE RAKE CARBIDE INSERTS

SCMT-HM

HM - Medium Geometry. Periphery Ground Insert. Mixed Production

HM - With a sharp wave cutting edge to reduce cutting force, it is the first choice for semi-finishing of internal holes and allows chips to flow smoothly.



10 PC PER PACKAGE

Item#	ANSI Insert No.	ISO Insert No.	I.C.	L	(Inch) S	d	r	Grade	Price (F)
6004-3030*	SCMT-21.51	SCMT060204	1/4	1/4	3/32	2.8	.0157	TiN(C6)	5.38
6004-3031	SCMT-32.51-HM	SCMT09T304HM	3/8	3/8	5/32	0.17	.0157	XAB749	8.70
6004-3032	SCMT-32.52-HM	SCMT09T308HM	3/8	3/8	5/32	0.17	.0315	XAB749	8.70
6004-3432	SCMT-432-HM	SCMT120408HM	1/2	1/2	3/16	7/32	.0315	XAB749	10.98

*Limited Supply

SCMT/HR SQUARE - POSITIVE RAKE CARBIDE INSERTS

SCMT-HR

HR- General Chipbreaker for Roughing. Stainless Steel Material

HR - M-class tolerance; suitable for both boring and O.D. roughing materials as steel, stainless steel and cast iron etc.

Limited Supply!

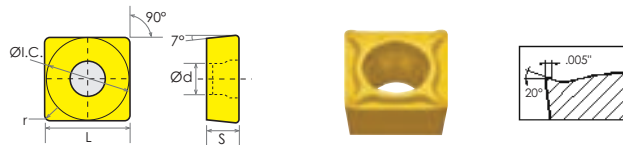

10 PC PER PACKAGE

Item#	ANSI Insert No.	ISO Insert No.	I.C.	L	(Inch) S	d	r	Grade	Price (F)
6056-1431	SCMT-431-HR	SCMT120404HR	1/2	1/2	3/16	7/32	.0157	XAB749	6.12

SD-POSITIVE RAKE CARBIDE INSERTS

SD

11° Relief Angle-Positive Rake

TiN COATED(C-6)

10 PC PER PACKAGE

Item#	ANSI Insert No.	ISO Insert No.	I.C.	T	r	Price (F)
6029-2322	SD-322P	SD160308P	3/8"	1/8"	1/32"	8.28
6029-2422	SD-422P	SD220308P	1/2"	1/8"	1/32"	9.10

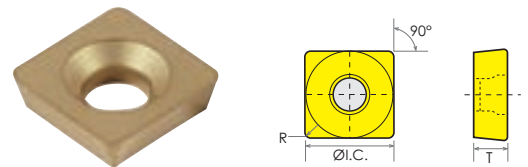

SEAN TiN (C5) CARBIDE INSERTS

SEAN

- Square 20° positive milling insert
- Used for face mill

TiN COATED(C-5)

Item#	ANSI Insert No.	ISO Insert No.	bs	(Inch) I.C.	T	Price (F)
6016-0040*	SEAN-42AFN	SEAN1203AFN	.071	.500	1/8	9.70
6016-0042	SEAN-42AFTN	SEAN1203AFTN	.071	.500	1/8	9.70
6016-0043*	SEAN-43AFN	SEAN1204AFN	.071	.500	3/16	9.70

*Limited Supply

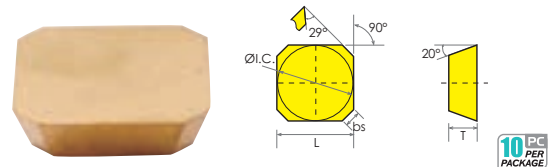

10 PC PER PACKAGE

SEET/DR CARBIDE INSERT

SEET-DR

DR - Used for roughing of material. It can achieve a high rate of metal removal & a low cutting force.

Item#	ANSI Insert No.	ISO Insert No.	I.C.	bs	S	Grade	Price (F)
6016-0123	SEET-42-AFER	SEET12T3-DR	.500"	.071"	.157"	XAB699	12.48



10 PC PER PACKAGE

CARBIDE INSERTS

SEET/DM CARBIDE INSERT

SEET-DM

DM - Widely used chip-breaker is used for semi-finishing and finishing of steel and stainless steel

Limited Supply!

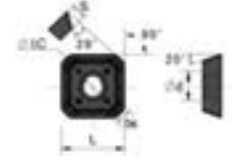
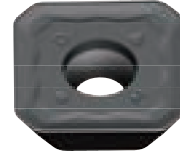

10 PC PER PACKAGE

Item#	ANSI Insert No.	ISO Insert No.	I.C.	bs	S	Grade	Price (F)
6016-1123	SEET-42-AFEM	SEET12T3-DM	.500"	.071"	.157"	XAB698	12.48

SEHT CARBIDE FACE MILL INSERT

SEHT

- 20° positive single sided chip breaker
- 4 cutting edges
- Wiper flat parallel land.

TiN COATED(C-6)

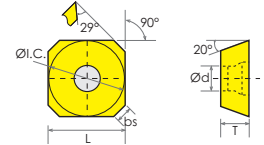

10 PC PER PACKAGE

Item#	ANSI Insert No.	ISO Insert No.	I.C.	L	bs	T	d	Price (F)
6017-0432	SEHT120408	SEHT-432	1/2"	1/2"	.071"	3/16"	13/64"	10.22

SEKN/AFTN CARBIDE FACE MILL INSERTS

SEKN

- Without chip breaker
- 20° relief angle
- Medium milling applications.

Limited Supply!

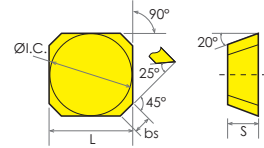

10 PC PER PACKAGE

Item#	ANSI Insert No.	I.C.	L	bs	S	Grade	Price (F)
6010-0002	SEKN-1203AFTN	1/2"	1/2"	.094"	1/8"	XAL749	11.28
6010-0012	SEKN-1204AFTN	1/2"	1/2"	.094"	3/16"	XAL649	10.03
6010-0006	SEKN-1504AFTN	5/8"	5/8"	.094"	3/16"	XAL749	10.19

SNKN CARBIDE FACE MILL INSERTS

SNKN

Item#	ANSI Insert No.	I.C.	F	a	S	Grade	Price (F)
6010-1003	SNKN-1204ENN	1/2"	0.059"	0.035"	3/16"	XAB699	12.90
6010-1006	SNKN-1504ENN	5/8"	0.059"	0.035"	3/16"	XAB699	10.56



Limited Supply!



10 PC PER PACKAGE

SNMA SQUARE - NEGATIVE RAKE CARBIDE INSERTS WITH HOLE

SNMA

- Square without chip breaker.
- 0° relief angle.
- Double sided.

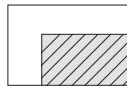

Limited Supply!

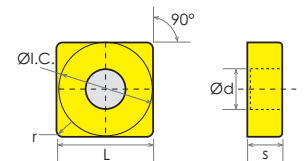

10 PC PER PACKAGE

Item#	ANSI Insert No.	ISO Insert No.	I.C.	L	(Inch) S	d	r	Grade	Price (F)
6001-8432	SNMA-432	SNMA120408	1/2	1/2	3/16	13/64	.0315	XAC849	6.16
6001-8433	SNMA-433	SNMA120412	1/2	1/2	3/16	13/64	.0472	XAC849	6.16
6001-8542	SNMA-542	SNMA150608	5/8	5/8	1/4	1/4	.0315	XAC849	10.20
6001-8643	SNMA-643	SNMA190612	3/4	3/4	1/4	5/16	.0472	XAC849	12.52
6001-8644	SNMA-644	SNMA190616	3/4	3/4	1/4	5/16	.0630	XAC849	12.52

SNMG TiN (C5) CARBIDE FACE MILL INSERTS

SNMG

- Square with chip breaker
- 0° relief angle
- Double sided cutting edges.
- Used for a wide range of materials and applications.

TiN COATED(C-5)

Limited Supply!

Item#	ANSI Insert No.	ISO Insert No.	(Inch) I.C.	T	Price (F)
6001-0322	SNMG-322	SNMG090308	3/8	1/8	5.45
6001-0432	SNMG-432	SNMG120408	1/2	3/16	10.63
6001-0433	SNMG-433	SNMG120412	1/2	3/16	9.35
6001-0643	SNMG-643	SNMG190612	3/4	1/4	17.59

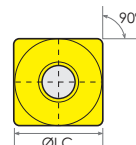

10 PC PER PACKAGE

SNMG/DF SQUARE-NEGATIVE RAKE CARBIDE INSERTS

SNMG-DF

DF - For Steel Finishing

Limited Supply!

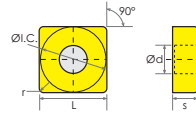
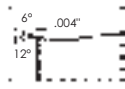

10 PC PER PACKAGE

Item#	ANSI Insert No.	ISO Insert No.	I.C.	L	S	d	r	Grade	Price (F)
6001-4432	SNMG-432-DF	SNMG120408DF	1/2"	1/2"	3/16"	13/64"	.0315"	XAB749	6.16
6001-4433	SNMG-433-DF	SNMG120412DF	1/2"	1/2"	3/16"	13/64"	.0472"	XAB749	6.16

SNMG/DF BLACK DIAMOND COATED CARBIDE INSERTS

SNMG-DF

DF - For Steel Finishing

Limited Supply!

TICNAI COATED

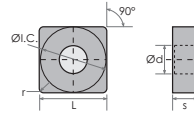
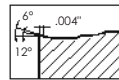

10 PC PER PACKAGE

Item#	ANSI Insert No.	ISO Insert No.	I.C.	L	S	d	r	Grade	Price (F)
6035-1432	SNMG-432-DF	SNMG120408DF	1/2"	1/2"	3/16"	13/64"	.0315"	XAB848	6.16
6035-1433	SNMG-433-DF	SNMG120412DF	1/2"	1/2"	3/16"	13/64"	.0472"	XAB848	6.16

SNMG/DM SQUARE-NEGATIVE RAKE CARBIDE INSERTS

SNMG-DM

DM - For Steel Medium Machining

DM - Widely used chip-breaker is used for semi-finishing and finishing of steel and stainless steel

Limited Supply!

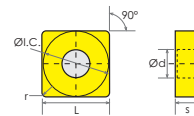
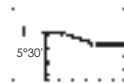

10 PC PER PACKAGE

Item#	ANSI Insert No.	ISO Insert No.	I.C.	L	(Inch) S	d	r	Grade	Price (F)
6001-5433	SNMG-433-DM	SNMG120412DM	1/2"	1/2"	3/16"	13/64"	.0472"	XAB749	6.16
6001-5543	SNMG-543-DM	SNMG150612DM	5/8"	5/8"	1/4"	1/4"	.0472"	XAB749	9.75
6001-5643	SNMG-643-DM	SNMG190612DM	3/4"	3/4"	1/4"	5/16"	.0472"	XAB749	12.52
6001-5644	SNMG-644-DM	SNMG190616DM	3/4"	3/4"	1/4"	5/16"	.0630"	XAB749	12.52

SNMG/DM BLACK DIAMOND COATED CARBIDE INSERTS

SNMG-DM

DM - For Steel Medium Machining

DM - Widely used chip-breaker is used for semi-finishing and finishing of steel and stainless steel

Limited Supply!

TICNAI COATED

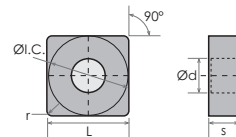
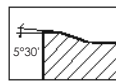

10 PC PER PACKAGE

Item#	ANSI Insert No.	ISO Insert No.	I.C.	L	(Inch) S	d	r	Grade	Price (F)
6035-0543	SNMG-543-DM	SNMG150612DM	5/8"	5/8"	1/4"	1/4"	.0472"	XAB748	9.75
6035-0643	SNMG-643-DM	SNMG190612DM	3/4"	3/4"	1/4"	5/16"	.0472"	XAB748	12.52
6035-0644	SNMG-644-DM	SNMG190616DM	3/4"	3/4"	1/4"	5/16"	.0630"	XAB748	12.52

SNMG/DR SQUARE - NEGATIVE RAKE CARBIDE INSERTS

SNMG-DR

DR- For Light Roughing of Steel, Stainless Steel Material

DR - Single-side chipbreaker with M-class tolerance has high security on cutting edge for higher removal rates and low cutting force at large cutting depth and high feed rates.

Limited Supply!

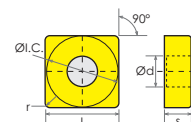
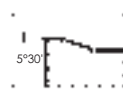

10 PC PER PACKAGE

Item#	ANSI Insert No.	ISO Insert No.	I.C.	L	S	d	r	Grade	Price (F)
6049-1432	SNMG-432-DR	SNMG120408DR	1/2"	1/2"	3/16"	13/64"	.0315"	XAB748	5.35
6049-1433	SNMG-433-DR	SNMG120412DR	1/2"	1/2"	3/16"	13/64"	.0472"	XAB748	5.35
6049-1543	SNMG-543-DR	SNMG150612DR	5/8"	5/8"	1/4"	1/4"	.0472"	XAB748	8.43
6049-1544	SNMG-544-DR	SNMG150616DR	5/8"	5/8"	1/4"	1/4"	.0630"	XAB748	8.43
6049-1644	SNMG-644-DR	SNMG190616DR	3/4"	3/4"	1/4"	5/16"	.0630"	XAB748	10.84

CARBIDE INSERTS

SNMG/EF CARBIDE INSERTS

SNMG-EF

EF - For Stainless Steel, Highly Adhesive and Plastic Materials

EF Chip-Breaker specially designed rake angle and an inclined edge angle for machining stainless steel. The edges are sharp making the cutting light and smooth, getting good control of the chips and obtaining a good surface quality, which makes it most suitable for ultra fine and fine machining of highly adhesive and plastic materials.

Limited Supply!

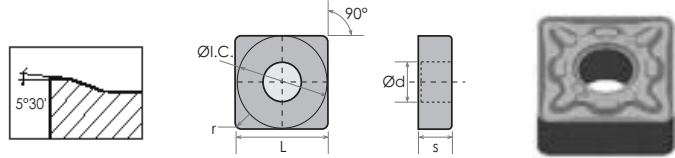

10 PC PER PACKAGE

Item#	ANSI Insert No.	ISO Insert No.	I.C.	L	(Inch) S	d	r	Grade	Price (F)
6035-5322	SNMG-322-EF	SNMG090308EF	3/8	3/8	1/8	0.15	.0315	XAF798	4.25
6035-5432	SNMG-432-EF	SNMG120408EF	1/2	1/2	3/16	13/64	.0315	XAF798	6.16
6035-5543	SNMG-543-EF	SNMG150612EF	5/8	5/8	1/4	1/4	.0472	XAF798	9.75

SNMG/EM SQUARE - NEGATIVE RAKE CARBIDE INSERTS

SNMG-EM

EM - Semi-Finishing Geometry. Stainless Steel Material

EM - Double-side chipbreaker with M-class tolerance serves to reduce cutting force and workpiece adhesion when machining stainless steel. Possesses higher feed and depth of cut capability than EF chipbreaker.

Limited Supply!

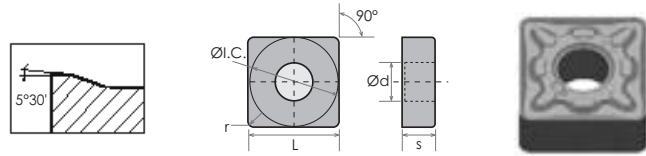

10 PC PER PACKAGE

Item#	ANSI Insert No.	ISO Insert No.	I.C.	L	(Inch) S	d	r	Grade	Price (F)
6049-0432	SNMG-432-EM	SNMG120408EM	1/2	1/2	3/16	13/64	.0315	XAF798	10.02
6049-0433	SNMG-433-EM	SNMG120412EM	1/2	1/2	3/16	13/64	.0472	XAF798	10.02
6049-0543	SNMG-543-EM	SNMG150612EM	5/8	5/8	1/4	1/4	.0472	XAF798	13.96

SNMG/PM SQUARE - NEGATIVE RAKE CARBIDE INSERTS

SNMG-PM

PM - Suitable for Mixed Production

PM - With stronger cutting edge, it is better for intermittent cutting than -DM, with wider cutting zone of steel materials

Limited Supply!

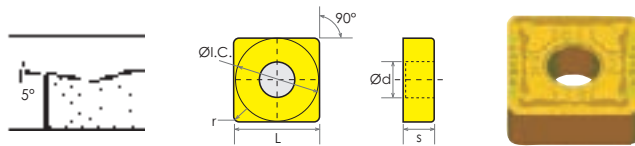

10 PC PER PACKAGE

Item#	ANSI Insert No.	ISO Insert No.	I.C.	L	(Inch) S	d	r	Grade	Price (F)
6001-6432	SNMG-432-PM	SNMG120408PM	1/2	1/2	3/16	13/64	.0315	XAB749	6.16
6001-6433	SNMG-433-PM	SNMG120412PM	1/2	1/2	3/16	13/64	.0472	XAB749	6.16
6001-6434	SNMG-434-PM	SNMG120416PM	1/2	1/2	3/16	13/64	.0630	XAB749	6.16
6001-6543	SNMG-543-PM	SNMG150612PM	5/8	5/8	1/4	1/4	.0472	XAB749	9.75
6001-6643	SNMG-643-PM	SNMG190612PM	3/4	3/4	1/4	5/16	.0472	XAB749	12.52

SPG CARBIDE INSERTS

SPG

C-6 for all steel and general purpose
TiN Coated for high heat & wear resistance on alloys, stainless steel & ductile iron

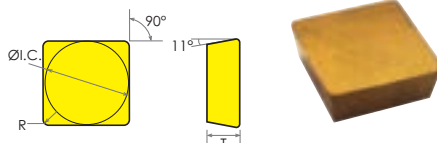

TiN Coated(C-6)

10 PC PER PACKAGE

Item#	ANSI Insert No.	I.C.	(Inch) T	R	Price (F)
6021-2322*	SPG-322	3/8	1/8	1/32	3.65
6021-2422	SPG-422	1/2	1/8	1/32	5.17
6021-2432	SPG-432	1/2	3/16	1/32	6.86
6021-2533*	SPG-533	5/8	3/16	3/64	9.94
6021-2633	SPG-633	3/4	3/16	3/64	12.57

*Limited Supply

SPKN/ED CARBIDE FACE MILL INSERTS

SPKN

- Used for milling
- 11° relief angle

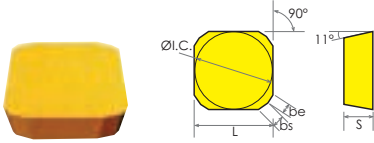

10 PC PER PACKAGE

Item#	ANSI Insert No.	Feeding Direction	I.C.	L	(Inch) bs	be	s	Grade	Price (F)
6010-2003*	SPKN-1203EDL	Left	1/2	1/2	0.055	0.039	1/8	XAB699	6.73
6010-2004	SPKN-1203EDR	Right	1/2	1/2	0.055	0.039	1/8	XAB699	10.98
6010-2009*	SPKN-1504EDL	Left	5/8	5/8	0.055	0.039	3/16	XAB699	10.03
6010-2010*	SPKN-1504EDR	Right	5/8	5/8	0.055	0.039	3/16	XAB699	14.88

*Limited Supply

SPMR CARBIDE INSERT

SPMR

- Screw on style.
- Single sided with chip breaker.
- -11° relief.

Limited Supply!

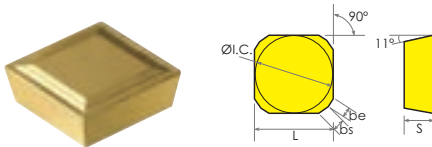

10 PC PER PACKAGE

Item#	ANSI Insert No.	ISO Insert No.	I.C.	L	(Inch) S	r	Grade	Price (F)
6004-5321	SPMR-321	SPMR090304	3/8	3/8	1/8	.0156	XAB749	2.66
6004-5322	SPMR-322	SPMR090308	3/8	3/8	1/8	.031	XAB749	2.66
6004-5421	SPMR-421	SPMR120304	1/2	1/2	1/8	.0156	XAB749	3.50
6004-5422	SPMR-422	SPMR120308	1/2	1/2	1/8	.031	XAB749	3.50

SPMT CARBIDE INSERT

SPMT

- Screw on style.
- Single sided with chip breaker.
- -11° relief.

10 PC PER PACKAGE

Item#	ANSI Insert No.	ISO Insert No.	I.C.	(Inch) S	d	r	Grade	Price (F)
6018-3251	SPMT32.51	SPMT09T304	3/8	5/32	0.173	0.0156	TiN	8.50
6018-3252	SPMT32.52	SPMT09T308	3/8	5/32	0.173	0.031	TiN	8.50
6018-3432	SPMT432	SPMT120408	1/2	3/16	0.216	0.031	XAF698	8.05

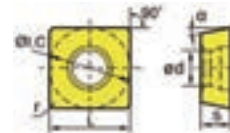

*Limited Supply

SPU CARBIDE INSERTS

SPU

- C-2** for cast iron and general purpose.
- C-6** for all steel and general purpose
- TiN Coated** for high heat & wear resistance on alloys, stainless steel & ductile iron

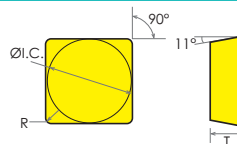

10 PC PER PACKAGE

ANSI Insert No.	I.C.	T	R	C-2 Item#	Price (F)	C-6 Item#	Price (F)	TiN Coated(C-6) Item#	Price (F)
SPU-322	3/8"	1/8"	1/32"	-----		-----		6022-2322*	4.99
SPU-422	1/2"	1/8"	1/32"	-----		6022-1422	2.70	6022-2422	6.84
SPU-633	3/4"	3/16"	3/64"	6022-0633*	6.50	6022-1633*	6.72	-----	

*Limited Supply

TCGX/LH CARBIDE INSERTS FOR ALUMINUM ALLOY

TCGX-LH

- LH Chip-Breaker** is more suitable for machining aluminum alloy with larger cutting depth and higher feed rate

Limited Supply!

10 PC PER PACKAGE

Item#	ANSI Insert No.	ISO Insert No.	I.C.	L	(Inch) S	d	r	Grade	Price (F)
6057-0100	TCGX1.8(1.5)0-LH	TCGX090202-LH	7/32	.378	3/32	.098	.008	XC899	6.64
6057-0101	TCGX1.8(1.5)1-LH	TCGX090204-LH	7/32	.378	3/32	.098	.016	XC899	6.64
6057-0110	TCGX2(1.5)0-LH	TCGX110202-LH	1/4	.433	3/32	.110	.008	XC899	6.86
6057-0111	TCGX2(1.5)1-LH	TCGX110204-LH	1/4	.433	3/32	.110	.016	XC899	6.86
6057-0112	TCGX2(1.5)2-LH	TCGX110208-LH	1/4	.433	3/32	.110	.031	XC899	6.86
6057-0221	TCGX3(2.5)1-LH	TCGX16T304-LH	3/8	.650	5/32	.173	.016	XC899	7.81
6057-0222	TCGX3(2.5)2-LH	TCGX16T308-LH	3/8	.650	5/32	.173	.031	XC899	7.83

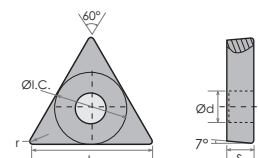

TCMT TiN (C6) TRIANGLE - POSITIVE RAKE CARBIDE INSERTS

TCMT

- Single sided for semi-finishing.
- 7° relief angle
- Triangle with chipbreaker.

TiN COATED (C-6)

Item#	ANSI Insert No.	ISO Insert No.	I.C.	L	(Inch) S	d	r	Price (F)
6004-9020	TCMT-1.8(1.5)	TCMT090204	0.219	0.378	0.094	0.098	0.016	6.00
6004-9021	TCMT-21.51	TCMT110204	1/4	7/16	3/32	7/64	.0157	5.76
6004-9022	TCMT-21.52	TCMT110208	1/4	7/16	3/32	7/64	.0315	5.76
6004-9018*	TCMT1.2(1.2)1L	TCMT06T104L	0.156	0.272	0.078"	0.071"	0.016	5.11
6004-9024	TCMT221L	TCMT110304L	0.250	0.41	0.126"	0.125"	.0157	6.46
6004-9031	TCMT-32.51	TCMT16T304	3/8	5/8	5/32	0.17	.0157	5.83
6004-9032	TCMT-32.52	TCMT16T308	3/8	5/8	5/32	0.17	.0315	5.83
6004-6141	TCMT-431	TCMT220404	1/2	7/8	3/16	0.22	.0157	10.55
6004-6142	TCMT-432	TCMT220408	1/2	7/8	3/16	0.22	.0315	10.55

*Limited Supply

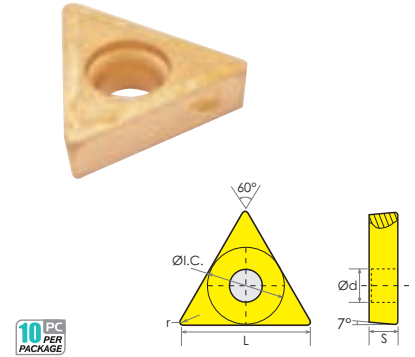

TCMT/HF TRIANGLE - POSITIVE RAKE CARBIDE INSERTS

TCMT-HF

HF - Finishing Geometry. Mixed Production

HF - With sharp cutting edge, used for finishing internal holes, fine finishing of surface can be achieved with a slow feed rate.

Limited Supply!

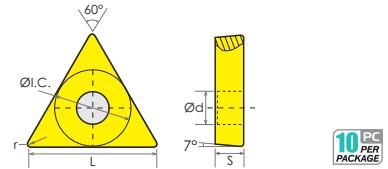
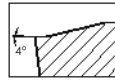

Item#	ANSI Insert No.	ISO Insert No.	I.C.	L	(Inch) S	d	r	Grade	Price (F)
6004-6022	TCMT-21.52-HF	TCMT110208HF	1/4	7/16	3/32	7/64	.0315	XAB849	3.72
6004-6032	TCMT-32.52-HF	TCMT16T308HF	3/8	5/8	5/32	0.17	.0315	XAB849	5.93

TCMT/HM TRIANGLE - POSITIVE RAKE CARBIDE INSERTS

TCMT-HM

HM - Medium Geometry. Periphery Ground Insert. Mixed Production

HM - With sharp wave cutting edge to reduce cutting force, it is the first choice for semi-finishing of internal holes and allows chips to flow smoothly.

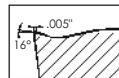

Limited Supply!

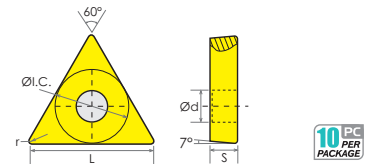

Item#	ANSI Insert No.	ISO Insert No.	I.C.	L	(Inch) S	d	r	Grade	Price (F)
6004-7032	TCMT-32.52-HM	TCMT16T308HM	3/8	5/8	5/32	0.17	.0315	XAB749	6.86
6004-7033	TCMT-32.53-HM	TCMT16T312HM	3/8	5/8	5/32	0.17	.0472	XAB749	5.94

TDEX 60° TRIANGLE CARBIDE INSERTS

TDEX

- 60° indexable dovetail milling cutter
- Honed edge allows for a heavier cuts.
- For special applications
- 3 cutting edges.

TiN (C5) COATED

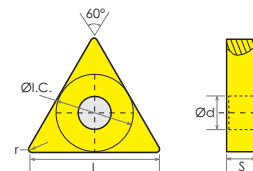

Item#	ANSI Insert No.	ISO Insert No.	I.C.	L	(Inch) S	d	r	TiN Coated Grade	Price (F)
6062-0215	TDEX 21.5	TDEX110204	1/4	7/16	3/32	7/64	.0157	C-5	5.80
6062-0320	TDEX32	TDEX16T308	3/8	5/8	5/32	0.17	.0315	C-5	6.98
6062-0430	TDEX43	TDEX220408	1/2	7/8	3/16	0.22	.0315	C-5	11.18

TNMA TRIANGLE - NEGATIVE RAKE CARBIDE INSERTS

TNMA

11° Relief Angle, Flat Top Insert

Limited Supply!

Item#	ANSI Insert No.	ISO Insert No.	I.C.	L	(Inch) S	d	r	Grade	Price (F)
6002-6332	TNMA-332	TNMA160408	3/8	5/8	3/16	0.15	.0315	XAC849	5.52
6002-6333	TNMA-333	TNMA160412	3/8	5/8	3/16	0.15	.0472	XAC849	5.52
6002-6432	TNMA-432	TNMA220408	1/2	7/8	3/16	13/64	.0315	XAC849	7.63

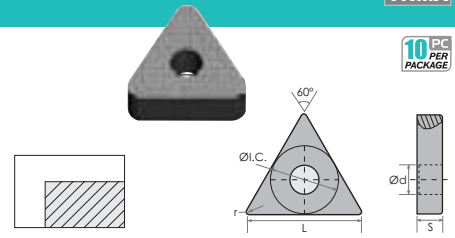

10 PC PER PACKAGE

TNMC GROOVING CARBIDE INSERTS

TNMC

- Right hand on two sides.
- Neutral rake angle.
- Double countersink thru hole.
- TiN coated.

TiN Coated



*Limited Supply

Item#	ANSI Insert No.	Pitch	I.C. (In)	Pitch	Groove Width (In)	Groove Depth (In)	Price (F)
6043-0632	TNMC-32NGR031	8 TPI Max.	0.375	8 TPI Max.	.031	.075	12.15
6043-0633	TNMC-32NGR062	8 TPI Max.	0.375	8 TPI Max.	.062	.150	12.15
6043-0634	TNMC-32NGR094	8 TPI Max.	0.375	8 TPI Max.	.094	.150	12.15
6043-0635	TNMC-32NGR125	8 TPI Max.	0.375	8 TPI Max.	.125	.150	12.15
6043-0643	TNMC-43NGR062	6 TPI Max.	0.500	6 TPI Max.	.062	.125	17.65
6043-0644	TNMC-43NGR094	6 TPI Max.	0.500	6 TPI Max.	.094	.150	17.65
6043-0645	TNMC-43NGR125	6 TPI Max.	0.500	6 TPI Max.	.125	.210	17.65
6043-0646*	TNMC-43NGR156	6 TPI Max.	0.500	6 TPI Max.	.156	.210	14.63
6043-0647*	TNMC-43NGR187	6 TPI Max.	0.500	6 TPI Max.	.187	.210	13.41
6043-0654*	TNMC-54NGR250	4 TPI Max.	0.625	4 TPI Max.	.250	.210	13.80

TNMG TRIANGLE - NEGATIVE RAKE CARBIDE INSERTS

TNMG

- Triangle with chipbreaker
- 0° relief angle

Item#	ANSI Insert No.	ISO Insert No.	I.C.	L	(Inch) S	d	r	Price (F)
6002-0001	TNMG-221	TNMG110304	1/4	7/16	1/8	.093	.0157	6.15
6002-0002	TNMG-222	TNMG110308	1/4	7/16	1/8	.093	.0315	6.15
6002-0011	TNMG-321	TNMG160404	3/8	5/8	1/8	0.15	.0157	6.15
6002-0012*	TNMG-322	TNMG160408	3/8	5/8	1/8	0.15	.0315	5.02
6002-0013	TNMG-323	TNMG160412	3/8	5/8	1/8	0.15	.0472	6.15
6002-0021	TNMG-431	TNMG220404	1/2	7/8	3/16	13/64	.0157	11.48
6002-0022	TNMG-432	TNMG220408	1/2	7/8	3/16	13/64	.0315	11.02
6002-0023*	TNMG-433	TNMG220412	1/2	7/8	3/16	13/64	.0472	12.65
6002-0024*	TNMG-434	TNMG220416	1/2	7/8	3/16	13/64	.0630	11.02

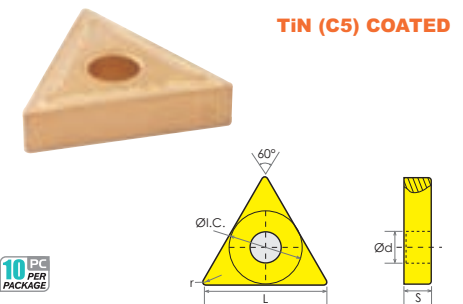

TiN (C5) COATED

10 PC PER PACKAGE

*Limited Supply

TNMG TRIANGLE - NEGATIVE RAKE CARBIDE INSERTS

TNMG

0° Relief Angle, Molded Chipbreaker

Limited Supply!

Item#	ANSI Insert No.	ISO Insert No.	I.C.	L	(Inch) S	d	r	Grade	Price (F)
6002-3433	TNMG-433	TNMG220412	1/2	7/8	3/16	13/64	.0472	XAB749	6.59
6002-3434	TNMG-434	TNMG220416	1/2	7/8	3/16	13/64	.0630	XAB749	6.59
6002-2543	TNMG-543	TNMG270612	5/8	1.08	1/4	1/4	.0472	XAB749	10.56
6002-2544	TNMG-544	TNMG270616	5/8	1.08	1/4	1/4	.0630	XAB749	10.56

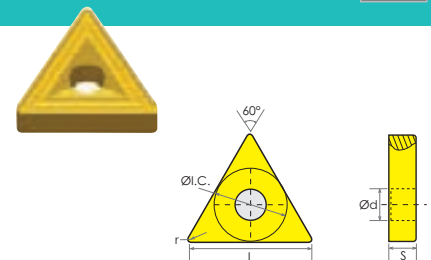

10 PC PER PACKAGE

TNMG/DF TRIANGLE - NEGATIVE RAKE CARBIDE INSERTS

TNMG-DF

DF - For Steel Finishing

Limited Supply!

Item#	ANSI Insert No.	ISO Insert No.	I.C.	L	(Inch) S	d	r	Grade	Price (F)
6001-9332	TNMG-332-DF	TNMG160408DF	3/8	5/8	3/16	0.15	.0315	XAB849	5.17
6001-9333	TNMG-333-DF	TNMG160412DF	3/8	5/8	3/16	0.15	.0472	XAB849	5.99
6001-9433	TNMG-433-DF	TNMG220412DF	1/2	7/8	3/16	13/64	.0472	XAB849	6.59

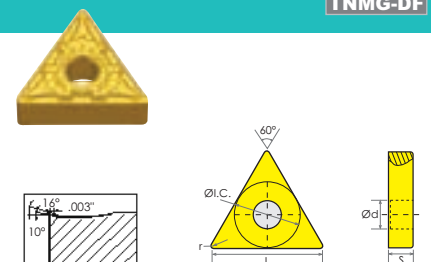

10 PC PER PACKAGE

TNMG/DF BLACK DIAMOND CARBIDE INSERTS

TNMG-DF

DF - For Steel Finishing

TiCNAI COATED

Limited Supply!

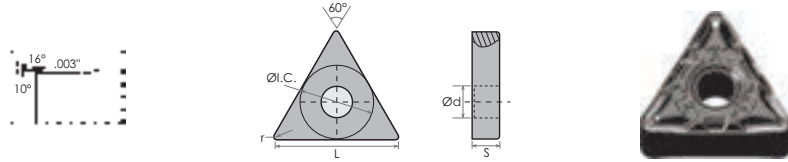

10 PC PER PACKAGE

Item#	ANSI Insert No.	ISO Insert No.	I.C.	L	(Inch) S	d	r	Grade	Price (F)
6036-0332	TNMG-332-DF	TNMG160408DF	3/8	5/8	3/16	0.15	.0315	XAB848	5.98
6036-0333	TNMG-333-DF	TNMG160412DF	3/8	5/8	3/16	0.15	.0472	XAB848	5.98
6036-0432	TNMG-432-DF	TNMG220408	1/2	7/8	3/16	13/64	.0315	XAB848	7.63
6036-0433	TNMG-433-DF	TNMG220412DF	1/2	7/8	3/16	13/64	.0472	XAB848	7.63

TNMG/DM BLACK DIAMOND CARBIDE INSERTS

TNMG-DM

DM - For Steel Medium Machining

TiCNAI COATED

DM - Widely used chipbreaker is used for semi-finishing and finishing of steel and stainless steel.

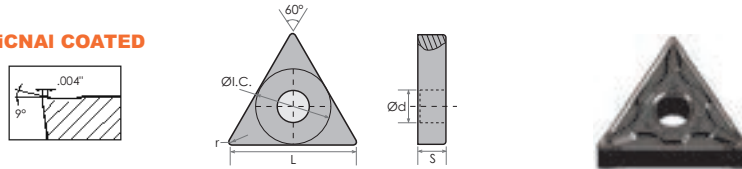

10 PC PER PACKAGE

Item#	ANSI Insert No.	ISO Insert No.	I.C.	L	(Inch) S	d	r	Grade	Price (F)
6036-1222	TNMG-222-DM	TNMG110308DM	1/4	7/16	1/8	0.09	.0157	XAB748	5.64
6036-1331	TNMG-331-DM	TNMG160404DM	3/8	5/8	3/16	0.15	.0157	XAB748	9.75
6036-1332	TNMG-332-DM	TNMG160408DM	3/8	5/8	3/16	0.15	.0315	XAB748	9.75
6036-1333*	TNMG-333-DM	TNMG160412DM	3/8	5/8	3/16	0.15	.0472	XAB748	5.98
6036-1431*	TNMG-431-DM	TNMG220404DM	1/2	7/8	3/16	13/64	.0157	XAB748	8.82
6036-1432	TNMG-432-DM	TNMG220408DM	1/2	7/8	3/16	13/64	.0315	XAB748	10.71
6036-1433*	TNMG-433-DM	TNMG220412DM	1/2	7/8	3/16	13/64	.0472	XAB748	7.63
6036-1434*	TNMG-434-DM	TNMG220416DM	1/2	7/8	3/16	13/64	.0630	XAB748	8.82

*Limited Supply

TNMG/DM TRIANGLE - NEGATIVE RAKE CARBIDE INSERTS

TNMG-DM

DM - For Steel Medium Machining

Limited Supply!

DM - Widely used chipbreaker is used for semi-finishing and finishing of steel and stainless steel.

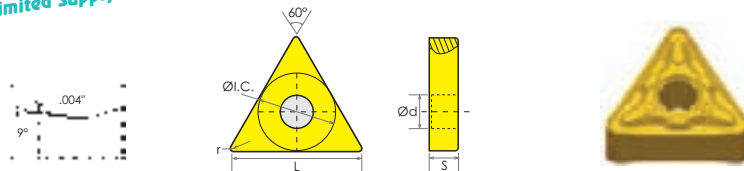

10 PC PER PACKAGE

Item#	ANSI Insert No.	ISO Insert No.	I.C.	L	(Inch) S	d	r	Grade	Price (F)
6002-0222	TNMG-222-DM	TNMG110308DM	1/4	7/16	1/8	0.09	.0157	XAB749	3.48
6002-0331	TNMG-331-DM	TNMG160404DM	3/8	5/8	3/16	0.15	.0157	XAB749	5.98
6002-0333	TNMG-333-DM	TNMG160412DM	3/8	5/8	3/16	0.15	.0472	XAB749	5.98
6002-0431	TNMG-431-DM	TNMG220404DM	1/2	7/8	3/16	13/64	.0157	XAB749	7.63
6002-0432	TNMG-432-DM	TNMG220408DM	1/2	7/8	3/16	13/64	.0315	XAB749	7.63
6002-0433	TNMG-433-DM	TNMG220412DM	1/2	7/8	3/16	13/64	.0472	XAB749	7.63
6002-0434	TNMG-434-DM	TNMG220416DM	1/2	7/8	3/16	13/64	.0630	XAB749	7.63

TNMG/EF - CARBIDE INSERTS

TNMG-EF

EF - For Stainless Steel, Highly Adhesive and Plastic Materials

EF Chip-Breaker specially designed rake angle and an inclined edge angle for machining stainless steel. The edges are sharp making the cutting light and smooth, getting a good control of the chips and obtaining a good surface quality, which makes it most suitable for ultra fine and fine machining of highly adhesive and plastic materials.

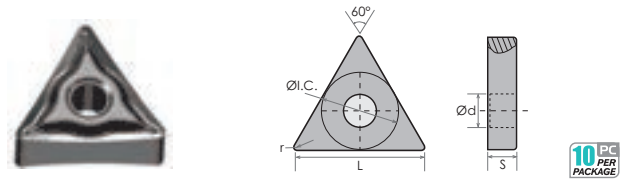

Item#	ANSI Insert No.	ISO Insert No.	I.C.	L	(Inch) S	d	r	Grade	Price (F)
6036-5331	TNMG-331-EF	TNMG160404EF	3/8	5/8	3/16	0.15	.0157	XAF798	6.93
6036-5332	TNMG-332-EF	TNMG160408EF	3/8	5/8	3/16	0.15	.0315	XAF798	8.40
6036-5333*	TNMG-333-EF	TNMG160412EF	3/8	5/8	3/16	0.15	.0472	XAF798	6.93
6036-5432	TNMG-432-EF	TNMG220408EF	1/2	7/8	3/16	13/64	.0315	XAF798	12.39
6036-5433*	TNMG-433-EF	TNMG220412EF	1/2	7/8	3/16	13/64	.0472	XAF798	7.63

*Limited Supply

TNMG/EM TRIANGLE - NEGATIVE RAKE CARBIDE INSERTS

TNMG-EM

EM - Semi-Finishing Geometry. Stainless Steel Material

EM - Double-side chipbreaker with M-class tolerance serves to reduce cutting force and workpiece adhesion when machining stainless steel. Possesses higher feed and depth of cut capability than EF chipbreaker.



Item#	ANSI Insert No.	ISO Insert No.	I.C.	L	(Inch) S	d	r	Grade	Price (F)
6050-0331*	TNMG-331-EM	TNMG160404EM	3/8	5/8	1/8	0.15	.0157	XAF795	6.93
6050-0332	TNMG-332-EM	TNMG160408EM	3/8	5/8	1/8	0.15	.0315	XAF795	9.75
6050-0432	TNMG-432-EM	TNMG220408EM	1/2	7/8	3/16	13/64	.0315	XAF795	12.39
6050-0433*	TNMG-433-EM	TNMG220412EM	1/2	7/8	3/16	13/64	.0472	XAF795	8.82

*Limited Supply

TNMG/PM TRIANGLE - NEGATIVE RAKE CARBIDE INSERTS

TNMG-PM

PM - Suitable for Mixed Production

PM - With stronger cutting edge, it is better for intermittent cutting than -DM, with wider cutting zone of steel materials

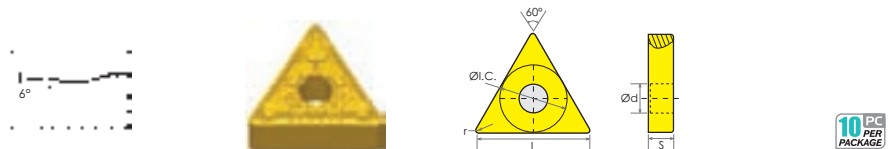

Item#	ANSI Insert No.	ISO Insert No.	I.C.	L	(Inch) S	d	r	Grade	Price (F)
6002-1222	TNMG-222-PM	TNMG110308PM	1/4	7/16	1/8	0.09	.0157	XAB749	5.64
6002-1331*	TNMG-331-PM	TNMG160404PM	3/8	5/8	3/16	0.15	.0157	XAB749	6.93
6002-1332	TNMG-332-PM	TNMG160408PM	3/8	5/8	3/16	0.15	.0315	XAB749	9.80
6002-1333*	TNMG-333-PM	TNMG160412PM	3/8	5/8	3/16	0.15	.0472	XAB749	6.93
6002-1432*	TNMG-432-PM	TNMG220408PM	1/2	7/8	3/16	13/64	.0315	XAB749	7.63
6002-1433*	TNMG-433-PM	TNMG220412PM	1/2	7/8	3/16	13/64	.0472	XAB749	7.63
6002-1434*	TNMG-434-PM	TNMG220416PM	1/2	7/8	3/16	13/64	.0630	XAB749	7.63

*Limited Supply

TNMM TRIANGLE - NEGATIVE RAKE CARBIDE INSERTS

TNMM

0° Relief Angle, Chipbreaker

Limited Supply!

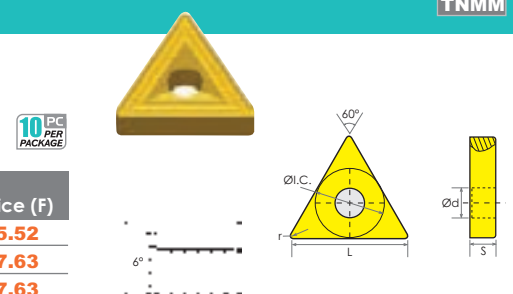

Item#	ANSI Insert No.	ISO Insert No.	I.C.	L	(Inch) S	d	r	Grade	Price (F)
6002-5332	TNMM-332	TNMM160408	3/8	5/8	1/8	0.15	.0315	XAB749	5.52
6002-5432	TNMM-432	TNMM220408	1/2	7/8	3/16	13/64	.0315	XAB749	7.63
6002-5433	TNMM-433	TNMM220412	1/2	7/8	3/16	13/64	.0472	XAB749	7.63

CARBIDE INSERTS

TPGB CARBIDE INSERTS 11° Positive Single Sided

TPGB

- TPGB for machining short chip materials without chipbreaker.
- With countersunk hole.
- Fits popular boring bar & turning tool holders.

10 PC PER PACKAGE



TiN COATED(C6)

Item#	ANSI Insert No.	I.C.	Thick (In)	Hole (In)	Price (F)
6025-0251	TPGB-21.51	1/4"	.094	.118	4.75
6025-0252*	TPGB-21.52	1/4"	.094	.118	3.76
6025-0321	TPGB-321	3/8"	.125	.125	6.48
6025-0322	TPGB-322	3/8"	.125	.125	5.48
6025-0431*	TPGB-431	1/2"	.188	.220	10.64
6025-0432	TPGB-432	1/2"	.188	.220	10.50

*Limited Supply

TPGC CARBIDE INSERTS, TRANGLE POSITIVE

TPGC

- Single sided with chipbreaker.
- 11° relief angle.
- Fully ground with countersink hole.
- Suitable for materials that create a short chip.

Limited Supply!

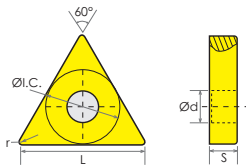

TiN (C5) COATED

10 PC PER PACKAGE

Item#	ANSI Insert No.	ISO Insert No.	I.C.	(Inch) T	R	Thru Hole	Price (F)
6025-0731	TPGC-321	TPGC160304	3/8	1/8	1/64	.125	5.13
6025-0732	TPGC-322	TPGC160308	3/8	1/8	1/32	.125	5.13

TPGH - POSITIVE RAKE CARBIDE INSERTS

TPGH

- Single sided with chipbreaker.
- 11° relief angle.
- Suitable for turning, facing and boring.

GRADE C-2 FOR CAST IRON AND GENERAL PURPOSE
GRADE C-6 FOR ALL STEEL AND GENERAL PURPOSE

ANSI Insert No.	ISO Insert No.	I.C.	(Inch) S	r	Hole d	C-2 Item#	Price (F)	C-5 Item#	Price (F)	TiN-55 (C-6) Item#	Price (F)
TPGH-731	-----	7/32	3/32	1/64	.098	6025-0010*	3.81	2003-0010	3.90	2003-0020	5.93
TPGH-21.51	TPGH110204	1/4	0.094	1/64	.110	6025-0011	6.03	2003-0011	5.57	2003-0021	7.30
TPGH-32.51	TPGH16T304	3/8	5/32	1/64	.173	6025-0014	5.88	2003-0014	6.65	2003-0023	8.50
TPGH-321	TPGH160304	3/8	1/8	1/64	.173	---		6025-1321	5.88	6025-2321	8.50
TPGH-322	TPGH160308	3/8	1/8	1/32	.173	---		6025-1322	5.88	6025-2322	8.50

*Limited Supply

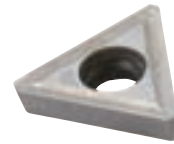

10 PC PER PACKAGE

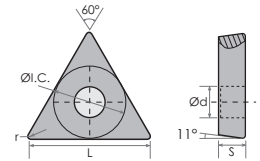

TPGN - POSITIVE RAKE CARBIDE INSERTS (TPG)

TPGN

- Single sided without chipbreaker.
- 11° relief angle.
- Suitable for difficult to cut materials.

GRADE C-2 FOR CAST IRON AND GENERAL PURPOSE
GRADE C-6 FOR ALL STEEL AND GENERAL PURPOSE

ANSI Insert No.	I.C.	(Inch) T	R	Uncoated C-2 Item#	Price (F)	Uncoated C-6 Item#	Price (F)	TiN Coated(C-6) Item#	Price (F)
TPG-21.51	1/4	.094	1/64	---		---		6020-1121	4.81
TPG-221	1/4	1/8	1/64	6020-2221	3.34	6020-0221	3.34	6020-1221	5.56
TPG-222	1/4	1/8	1/32	6020-2222	3.34	6020-0222	3.34	6020-1222	5.28
TPG-223	1/4	1/8	3/64	6020-2223	5.13	6020-0223	4.90	6020-1223	5.28
TPG-32.51	3/8	5/32	1/64	---		---		6020-1122	2.86
TPG-321	3/8	1/8	1/64	6020-2321	4.18	6020-0321	4.01	6020-1321	6.89
TPG-322	3/8	1/8	1/32	6020-2322	4.01	6020-0322	4.01	6020-1322	6.89
TPG-323	3/8	1/8	3/64	6020-2323	4.18	6020-0323	4.01	6020-1323	6.89
TPG-324	3/8	1/8	1/16	6020-2324	4.01	6020-0324	4.18	6020-1324	6.89
TPG-332	3/8	15/32	5/32	---		---		6004-9332	7.46
TPG-431	1/2	3/16	1/64	6020-2431	8.38	6020-0431*	6.37	6020-1431*	8.65
TPG-432	1/2	3/16	1/32	---		6020-0432*	6.37	6020-1432	10.01
TPG-433	1/2	3/16	3/64	---		6020-0433*	6.37	6020-1433*	10.01
TPG-434	1/2	3/16	1/16	6020-2434*	34.52	6020-0434*	6.37	6020-1434*	8.66

*Limited Supply

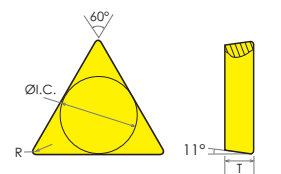

10 PC PER PACKAGE

TPGW CARBIDE INSERT 11° Positive Single Sided

TPGW

- 11° clearance angle.
- Positive insert shape.
- Screw on style.
- Fits many popular boring bar & turning tool holders.
- For machining short chip materials without a chipbreaker.

TiN (C6) coated

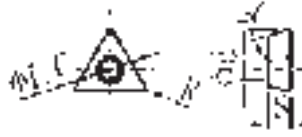

10 PC PER PACKAGE

Item#	ANSI Insert No.	ISO Insert No.	I.C.	Thickness S	(Inch) Corner Radius R	Hole Size d	Grade	Price (F)
6025-2152*	TPGW-21.52	TPGW110208	0.250	.093	.0315	0.110	TiN(C6)	4.53
6025-0222*	TPGW-222	TPGW110308	0.250	.125	.0315	0.110	TiN(C6)	5.36
6025-3321	TPGW-321	TPGW160304	0.375"	.125	.0157	0.173	TiN(C6)	5.78
6025-3322*	TPGW-322	TPGW160308	0.375"	.125	.0315	0.173	TiN(C6)	6.06
6025-4432*	TPGW-432	TPGW220408	0.500"	.187	.0315	0.217	TiN(C6)	7.49

*Limited Supply

TPKN CARBIDE MILLING INSERTS

TPKN

- For 90° mills.
- Wedge held inserts.
- 3 Indexes.

11° Relief Angle

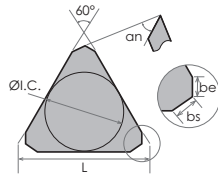

Limited Supply!



10 PC PER PACKAGE

Item#	ANSI Insert No.	I.C.	L	bs	be	an	S	Grade	Price (F)
6010-5003	TPKN-1603PDR	3/8"	5/8"	0.047"	0.039"	15°	1/8"	XB970R	8.91
6010-5010	TPKN-2204PDL	1/2"	7/8"	0.055"	0.028"	15°	3/16"	XB970R	7.68
6010-5011	TPKN-2204PDR	1/2"	7/8"	0.055"	0.028"	15°	3/16"	XB970R	12.54

TT/TPMM- POSITIVE RAKE CARBIDE INSERTS

TT/TPMM

- Single sided with chipbreaker.
- 11° relief angle.
- Suitable for turning, facing and boring.



10 PC PER PACKAGE

Insert No.		(Inch)				C-2		C-5		TiN Coated(C-6)	
ANSI	ISO	I.C.	S	R	d	Item#	Price (F)	Item#	Price (F)	Item#	Price (F)
TPMM-321	TPMM160304	3/8	1/8	1/64	.150	6026-0321	5.07	6026-1321	4.68	6026-2321	6.34
TPMM-322	TPMM160308	3/8	1/8	1/32	.150	6026-0322	4.68	6026-1322	4.68	6026-2322	6.86
TPMM-431	TPMM220404	1/2	3/16	1/64	.203	6026-0431*	5.50	6026-1431*	5.50	6026-2431	8.88
TPMM-432	TPMM220408	1/2	3/16	1/32	.203	6026-0432*	5.04	6026-1432*	5.04	6026-2432	8.88

*Limited Supply

TPMR - POSITIVE RAKE CARBIDE INSERTS

TRMR

- Single sided with chipbreaker.
- 11° relief angle.
- Suitable for semi finish cuts where chip control is required.

Limited Supply!

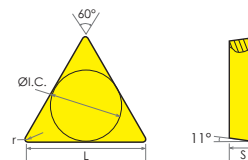
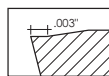

10 PC PER PACKAGE

Item#	ANSI Insert No.	ISO Insert No.	I.C.	L	(Inch) S	r	Grade	Price (F)
6005-0221	TPMR-221	TPMR110304	1/4	7/16	1/8	.0157	XAB849	3.96
6005-0222	TPMR-222	TPMR110308	1/4	7/16	1/8	.0315	XAB849	3.96
6005-0321	TPMR-321	TPMR160304	3/8	5/8	1/8	.0157	XAB849	4.64
6005-0323	TPMR-323	TPMR160312	3/8	5/8	1/8	.0472	XAB849	4.66

CARBIDE INSERTS

TPU CARBIDE INSERTS WITHOUT HOLE

TPU

C-6 for all steel and general purpose
TiN Coated for high heat & wear resistance on alloys, stainless steel & ductile iron



10 PC PER PACKAGE

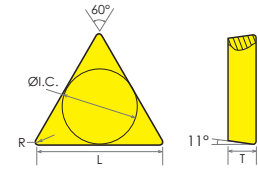

Insert No.	ISO	I.C.	(Inch) T	R	TiN Coated(C-6) Item#	Price (F)
TPU-322	TPU160308	3/8	1/8	1/32	6023-1322	3.83
TPU-323	TPU160312	3/8	1/8	3/64	6023-1323*	4.68

*Limited Supply

TPUN - POSITIVE RAKE CARBIDE INSERTS WITHOUT HOLE

TPUN

Limited Supply!

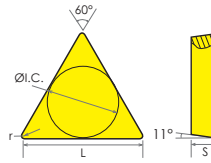
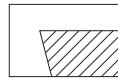

10 PC PER PACKAGE

Item#	ANSI Insert No.	ISO Insert No.	I.C.	L	(Inch) S	r	Grade	Price (F)
6005-2321	TPUN-321	TPUN160304	3/8	5/8	1/8	.0157	XAC849	4.11
6005-2322*	TPUN-322	TPUN160308	3/8	5/8	1/8	.0315	XAC849	4.11
6005-2323*	TPUN-323	TPUN160312	3/8	5/8	1/8	.0472	XAC849	3.55
6005-2432	TPUN-432	TPUN220408	1/2	7/8	3/16	.0157	XAC849	8.27
6005-2433	TPUN-433	TPUN220412	1/2	7/8	3/16	.0315	XAC849	6.62
6005-2434*	TPUN-434	TPUN220416	1/2	7/8	3/16	.0472	XAC849	6.62

VBMT/EM 35° DIAMOND- POSITIVE RAKE CARBIDE INSERTS

VBMT-EM

EM - Semi-Finishing Geometry. Stainless Steel Material

Limited Supply!

EM - Double-side chipbreaker with M-class tolerance serves to reduce cutting force and workpiece adhesion when machining stainless steel. Possesses higher feed and depth of cut capability than EF chipbreaker.

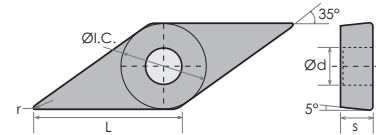

10 PC PER PACKAGE

Item#	ANSI Insert No.	ISO Insert No.	I.C.	L	(Inch) S	d	r	Grade	Price (F)
6059-0221	VBMT-0221-EM	VBMT110304EM	1/4	.017	1/8	0.11	.0157	XAF795	12.03
6059-0222	VBMT-0222-EM	VBMT110308EM	1/4	.017	1/8	0.11	.0315	XAF795	12.03

VBMT/HM 35° DIAMOND - POSITIVE RAKE CARBIDE INSERTS

VBMT-HM

HM - Medium Geometry. Periphery Ground Insert. Mixed Production

HM - With sharp wave cutting edge to reduce cutting force, it is the first choice for semi-finishing of internal holes and allows chips to flow smoothly.

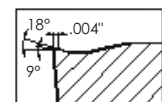
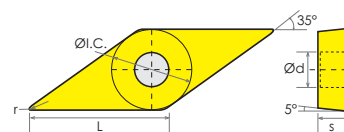

10 PC PER PACKAGE

Item#	ANSI Insert No.	ISO Insert No.	I.C.	(Inch) S	d	r	Grade	Price (F)
6005-2331	VBMT-331-HM	VBMT160404HM	3/8	3/16	.17	.0157	XAB749	13.35
6005-2332	VBMT-332-HM	VBMT160408HM	3/8	3/16	.17	.0315	XAB749	13.35

VCMT Tin 35° DIAMOND - POSITIVE RAKE CARBIDE INSERT

VCMT

- Tin coated, C-6 grade.

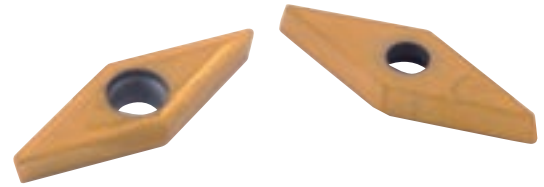
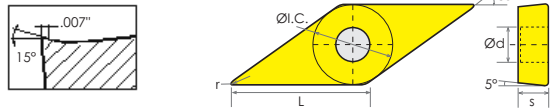

10 PC PER PACKAGE

Item#	ANSI Insert No.	I.C.	L	(Inch) S	d	r	Price (F)
6005-3403	VCMT21.51	0.250	0.41	0.10	0.106	.0157	5.83

VCGX/LH CARBIDE INSERTS FOR ALUMINUM ALLOY

VCGX-LH

LH Chip-Breaker is more suitable for machining aluminum alloy with larger cutting depth and higher feed rate

Limited Supply!

Item#	ANSI Insert No.	ISO Insert No.	I.C.	L	(Inch) S	d	r	Grade	Price (F)
6058-0111	VCGX2[1.5]1-LH	VCGX110104-LH	1/4	.433	3/32	.110	.016	XC899	8.32
6058-0221	VCGX-221-LH	VCGX110204-LH	1/4	.433	1/8	.110	.016	XC899	10.27
6058-0222	VCGX-222-LH	VCGX110208-LH	1/4	.433	1/8	.110	.031	XC899	10.27
6058-0332	VCGX-332-LH	VCGX160408-LH	3/8	.650	3/16	.173	.031	XC899	9.02

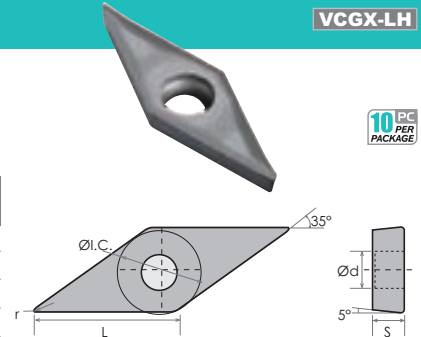

10 PC PER PACKAGE

VNMG/DF 35° DIAMOND - NEGATIVE RAKE CARBIDE INSERTS

VNMG-DF

DF - For Steel Finishing

Limited Supply!

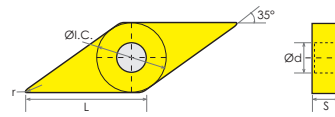
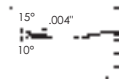

10 PC PER PACKAGE

Item#	ANSI Insert No.	ISO Insert No.	I.C.	L	S	d	r	Grade	Price (F)
6002-7331	VNMG-331-DF	VNMG160404DF	3/8	5/8	3/16	0.15"	.0157"	XAB849	9.35
6002-7332	VNMG-332-DF	VNMG160408DF	3/8	5/8	3/16	0.15"	.0315"	XAB849	9.35

VNMG/DM 35° BLACK-DIAMOND CARBIDE INSERTS

VNMG-DM

DM - For Steel Medium Machining

Limited Supply!

DM - Widely used chipbreaker is used for semi-finishing and finishing of steel and stainless steel.

TICNAI COATED

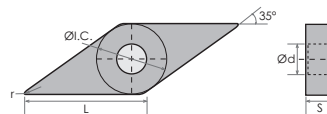
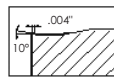

10 PC PER PACKAGE

Item#	ANSI Insert No.	ISO Insert No.	I.C.	L	S	d	r	Grade	Price (F)
6038-1332	VNMG-332-DM	VNMG160408DM	3/8	5/8	3/16	0.15"	.0315"	XAB748	10.78
6038-1333	VNMG-333-DM	VNMG160412DM	3/8	5/8	3/16	0.15"	.0472"	XAB748	9.35

VNMG/EF 35° - CARBIDE INSERTS

VNMG-EF

EF - For Stainless Steel, Highly Adhesive and Plastic Materials

Limited Supply!

EF Chip - Breaker specially designed rake angle and an inclined edge angle for machining stainless steel. The edges are sharp making the cutting light and smooth, getting a good control of the chips and obtaining a good surface quality, which makes it most suitable for ultra fine and fine machining of highly adhesive and plastic materials.

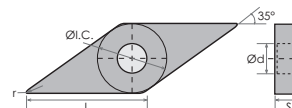

10 PC PER PACKAGE

Item#	ANSI Insert No.	ISO Insert No.	I.C.	L	S	d	r	Grade	Price (F)
6038-5332	VNMG-332-EF	VNMG160408EF	3/8	5/8	3/16	0.15"	.0315"	XAF798	9.35
6038-5333	VNMG-333-EF	VNMG160412EF	3/8	5/8	3/16	0.15"	.0472"	XAF798	9.35

CARBIDE INSERTS

VNMG/EM 35° DIAMOND- NEGATIVE RAKE CARBIDE INSERTS

VNMG-EM

EM - Semi-Finishing Geometry. Stainless Steel Material

EM - Double-side chipbreaker with M-class tolerance serves to reduce cutting force and workpiece adhesion when machining stainless steel. Possesses higher feed and depth of cut capability than EF chipbreaker.

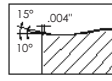

Limited Supply!

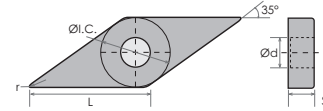

10 PC PER PACKAGE

Item#	ANSI Insert No.	ISO Insert No.	I.C.	L	(Inch) S	d	r	Grade	Price (F)
6051-0331	VNMG-331-EM	VNMG160404EM	3/8	5/8	3/16	0.15	.0157	XAF795	15.12
6051-0332	VNMG-332-EM	VNMG160408EM	3/8	5/8	3/16	0.15	.0315	XAF795	15.12

VNMG/PM 35° - CARBIDE INSERTS

VNMG-PM

PM - Suitable for Mixed Production

PM - With stronger cutting edge, it is better for intermittent cutting than -DM, with wider cutting zone of steel materials

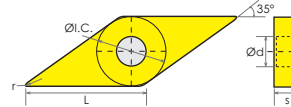
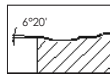

10 PC PER PACKAGE

Item#	ANSI Insert No.	ISO Insert No.	I.C.	L	(Inch) S	d	r	Grade	Price (F)
6002-9331	VNMG-331-PM	VNMG160404PM	3/8	5/8	3/16	0.15	.0157	XAB749	13.14
6002-9332	VNMG-332-PM	VNMG160408PM	3/8	5/8	3/16	0.15	.0315	XAB749	13.14
6002-9333	VNMG-333-PM	VNMG160412PM	3/8	5/8	3/16	0.15	.0472	XAB749	13.14

VNMS-TiN(C5) - CARBIDE INSERT

VNMS

- Double sided with chipbreaker
- 35° relief angle
- Used for turning and finishing on a wide range of materials.

Limited Supply!

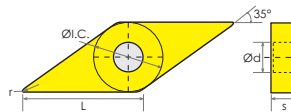
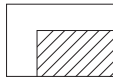

10 PC PER PACKAGE

Item#	ANSI Insert No.	ISO Insert No.	I.C.	L	S	d	r	Grade	Price (F)
6040-1332	VNMS-332	VNMS160408	3/8	5/8	3/16	0.15"	.0315"	TiN(C-5)	7.79

WCMT 80° TRIGON CARBIDE DRILLING INSERTS

WCMT

- Trigon 80° drilling insert.
- Positive rake.
- Chipbreaker.

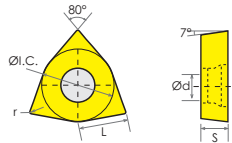

10 PC PER PACKAGE

Item#	ANSI Insert No.	I.C.	L	S	d	r	Grade	Price (F)
2002-0130	WCMT050308	5/16"	0.21"	1/8"	.126"	.0315"	TiN(C6)	5.57
2002-0126	WCMT06T304	3/8"	0.26"	5/32"	.173"	.0157"	TiN(C6)	6.79
2002-0128	WCMT06T308	3/8"	0.26"	5/32"	.173"	.0315"	TiN(C6)	6.06

WCMX 80° TRIGON CARBIDE DRILLING INSERTS

WCMX

- Trigon 80° drilling insert.
- Positive rake.
- Chipbreaker.

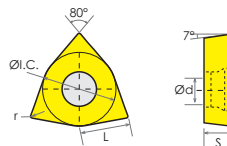

10 PC PER PACKAGE

Item#	ANSI Insert No.	I.C.	L	S	d	r	Grade	Price (F)
6015-0001*	WCMX030208-53	7/32"	0.15"	3/32"	7/64"	.0315"	XAF799	7.52
6015-0004*	WCMX040208R-53	1/4"	0.17"	3/32"	.122"	.0315"	XAF799	9.24
6015-0005	WCMX050308R-53	5/16"	0.21"	1/8"	1/8"	.0315"	XAF799	8.73
6015-0008	WCMX06T308R-53	3/8"	0.26"	5/32"	.146"	.0315"	XAF799	10.41

*Limited Supply

WNMA 80° TRIGON - NEGATIVE RAKE CARBIDE DRILLING INSERTS

WNMA

- Used for negative tool holders & boring bars.
- Trigon 80° drilling insert.
- No chipbreaker.
- 0° relief angle.

Limited Supply!

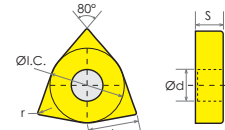
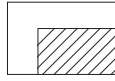

10 PC PER PACKAGE

Item#	ANSI Insert No.	ISO Insert No.	I.C.	L	S	d	r	Grade	Price (F)
6003-1431	WNMA-431	WNMA080404	1/2"	0.343"	3/16"	13/64"	.0157"	XAC849	6.95
6003-1433	WNMA-433	WNMA080412	1/2"	0.343"	3/16"	13/64"	.0472"	XAC849	5.39

WNMG/DF 80° TRIGON BLACK DIAMOND COATED CARBIDE DRILLING INSERTS

WNMG-DF

DF - For Finishing Geometry. Steel Materials

DF - Double-side chipbreaker with M-class tolerance for finish machining carbon and alloy steels.

TiCNAI COATED

Limited Supply!

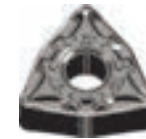

10 PC PER PACKAGE

Item#	ANSI Insert No.	ISO Insert No.	I.C.	L	(Inch) S	d	r	Grade	Price (F)
6039-0333	WNMG-333-DF	WNMG060412DF	3/8	0.256	0.187	0.15	.0472	XAB848	6.20

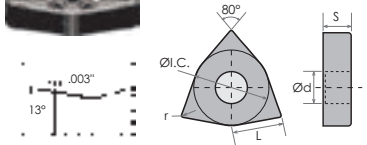

WNMG/DM 80° TRIGON BLACK DIAMOND COATED CARBIDE INSERTS

WNMG-DM

DM - For Steel Medium Machining

DM - Widely used chipbreaker is used for semi-finishing and finishing of steel and stainless steel.

TiCNAI COATED

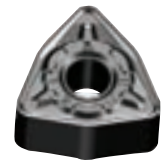
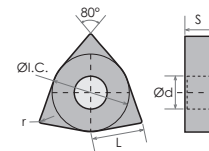
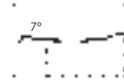

10 PC PER PACKAGE

Item#	ANSI Insert No.	ISO Insert No.	I.C.	L	(Inch) S	d	r	Grade	Price (F)
6039-1431	WNMG-431-DM	WNMG080404DM	1/2	0.343	3/16	13/64	.0157	XAB748	11.28
6039-1432	WNMG-432-DM	WNMG080408DM	1/2	0.343	3/16	13/64	.0315	XAB748	11.28

WNMG/DR 80° TRIGON BLACK DIAMOND COATED- CARBIDE INSERTS

WNMG-DR

DR - For Light Roughing of Steel

DR - Special chip-breaker with high toughness cutting edge can reduce cutting force

Limited Supply!



10 PC PER PACKAGE

Item#	ANSI Insert No.	ISO Insert No.	I.C.	L	(Inch) S	d	r	Grade	Price (F)
6052-1332	WNMG-332-DR	WNMG060408DR	3/8	0.256	3/16	0.15	.0315	XAB748	6.20
6052-1432	WNMG-432-DR	WNMG080408DR	1/2	0.343	3/16	13/64	.0315	XAB748	8.03
6052-1433	WNMG-433-DR	WNMG080412DR	1/2	0.343	3/16	13/64	.0472	XAB748	8.03

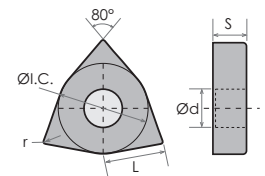

WNMG/EF 80° TRIGON- CARBIDE INSERTS

WNMG-EF

EF - For Stainless Steel, Highly Adhesive and Plastic Materials

EF Chip-Breaker specially designed rake angle and an inclined edge angle for machining stainless steel. The edges are sharp making the cutting light and smooth, getting a good control of the chips and obtaining a good surface quality, which makes it most suitable for ultra fine and fine machining of highly adhesive and plastic materials.



10 PC PER PACKAGE

Item#	ANSI Insert No.	ISO Insert No.	I.C.	L	(Inch) S	d	r	Grade	Price (F)
6039-5431	WNMG-431-EF	WNMG080404EF	1/2	0.343	3/16	13/64	.0157	XAF798	11.28
6039-5432	WNMG-432-EF	WNMG080408EF	1/2	0.343	3/16	13/64	.0315	XAF798	11.28

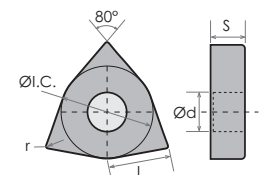

CARBIDE INSERTS

WNMG/EM 80° TRIGON- NEGATIVE RAKE CARBIDE INSERTS

WNMG-EM

EM - Semi-Finishing Geometry. Stainless Steel Material

EM - Double-side chipbreaker with M-class tolerance serves to reduce cutting force and workpiece adhesion when machining stainless steel. Possesses higher feed and depth of cut capability than EF chipbreaker.

Limited Supply!

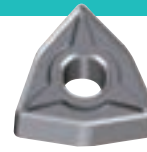

10 PC PER PACKAGE

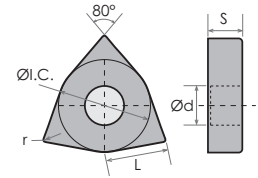

Item#	ANSI Insert No.	ISO Insert No.	I.C.	L	(Inch) S	d	r	Grade	Price (F)
6052-0332	WNMG-332-EM	WNMG060408EM	3/8	0.256	0.187	0.15	.0315	XAF795	8.73
6052-0432	WNMG-432-EM	WNMG080408EM	1/2	0.343	3/16	13/64	.0315	XAF795	8.73
6052-0433	WNMG-433-EM	WNMG080412EM	1/2	0.343	3/16	13/64	.0472	XAF795	8.03

WNMG/PM 80° TRIGON - NEGATIVE RAKE CARBIDE INSERTS

WNMG-PM

PM - Suitable for Mixed Production

PM - With stronger cutting edge, it is better for intermittent cutting than -DM, with wider cutting zone of steel materials



Limited Supply!

10 PC PER PACKAGE

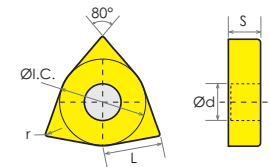

Item#	ANSI Insert No.	ISO Insert No.	I.C.	L	(Inch) S	d	r	Grade	Price (F)
6003-0431	WNMG-431-PM	WNMG080404PM	1/2		3/16	13/64	.0157	XAL749	6.00

WNMG 80° TRIGON - NEGATIVE RAKE CARBIDE INSERTS

WNMG

0° Relief Angle

TiN (C-5) Coated

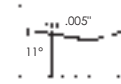

10 PC PER PACKAGE

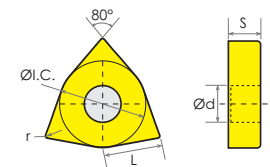

Item#	ANSI Insert No.	ISO Insert No.	I.C.	L	(Inch) S	d	r	Grade	Price (F)
6052-2331	WNMG-331	WNMG060404	3/8		3/16	0.15	.0157	TiN(C5)	8.50
6052-2332	WNMG-332	WNMG060408	3/8		3/16	0.15	.0315	TiN(C5)	8.50
6052-2432*	WNMG-432	WNMG080408	1/2		3/16	13/64	.0315	TiN(C5)	11.51
6052-2433*	WNMG-433	WNMG080412	1/2		3/16	13/64	.0472	TiN(C5)	11.51

*Limited Supply

INTERNAL V PARTIAL PROFILE CARBIDE THREADING INSERTS

- 60° V partial profile threading insert.
- Right hand cut.

TiN COATED

RIGHT HAND

10 PC PER PACKAGE

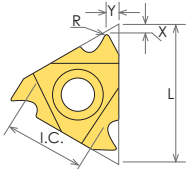

Item#	Insert	I.C.	Pitch Range mm	TPI	L (in)	R (in)	X (in)	Y (in)	Price (F)
6061-0156	06IRA60	.156"	0.5-1.25	48-20	.236	.002	.020	.024	20.36
6061-0187	08IRA60	.188"	0.5-1.5	48-16	.315	.002	.024	.028	20.36
6007-0008	11IRA60	1/4"	0.5-1.5	48-16	.435	.003	.031	.035	10.20
6007-0015	16IRAG60	3/8"	0.5-3.0	48-8	.630	.003	.047	.035	10.30
6007-0018	22IRN60	1/2"	3.5-5.0	5-7	.866	.010	.067	.098	17.18

EXTERNAL V PARTIAL PROFILE CARBIDE THREADING INSERTS

- 60° V partial profile threading insert.
- Right hand cut.

TiN COATED

RIGHT HAND

10 PC PER PACKAGE

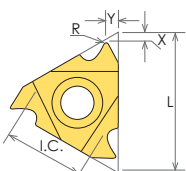

Item#	Insert	I.C.	Pitch Range mm	TPI	L (in)	R (in)	X (in)	Y (in)	Price (F)
6007-0002	06ERA60	.156"	0.5-1.25	48-20	.236	.002	.020	.024	21.53
6007-0001	08ERA60	.197"	0.5-1.5	48-16	.315	.002	.024	.028	19.16
6007-0004	11ERA60	1/4"	0.5-1.5	48-16	.435	.003	.031	.035	10.20
6007-0012	16ERAG60	3/8"	0.5-3.0	48-8	.630	.003	.047	.035	10.20
6007-0020	22ERN60	1/2"	3.5-5.0	5-7	.866	.016	.067	.098	17.00

UN-60° INTERNAL THREADING & GROOVING CARBIDE INSERTS-Inch Thread

Item#	Insert No.	I.C.	Screw Pitch	S	d	Grade	Price (F)
6006-4008	RT16.01N-8UN	3/8"	8 TPI	5/32"	0.173"	XAF799	14.84
6006-4010	RT16.01N-10UN	3/8"	10TPI	5/32"	0.173"	XAF799	14.84
6006-4012	RT16.01N-12UN	3/8"	12 TPI	5/32"	0.173"	XAF799	14.84
6006-4014	RT16.01N-14UN	3/8"	14 TPI	5/32"	0.173"	XAF799	14.84
6006-4016	RT16.01N-16UN	3/8"	16 TPI	5/32"	0.173"	XAF799	14.84
6006-4018	RT16.01N-18UN	3/8"	18 TPI	5/32"	0.173"	XAF799	14.84
6006-4020	RT16.01N-20UN	3/8"	20 TPI	5/32"	0.173"	XAF799	14.84

RIGHT HAND

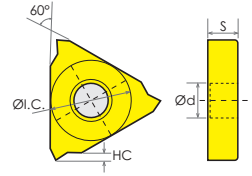

10 PC PER PACKAGE

UN-60° INTERNAL THREADING & GROOVING CARBIDE INSERTS -Inch Thread

- UN-60° full profile threading insert.
- Tolerance Class: 2A/2B
- TiAlN (TP04) coated .

TiAlN COATED

RIGHT HAND

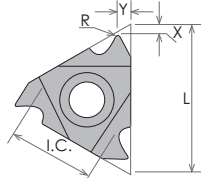

10 PC PER PACKAGE

Item#	Insert	I.C.	Screw Pitch TPI	L (in)	X (in)	Y (in)	Thick (in)	Price (F)
6006-4502	11NR-16UN	1/4	16	.433	.035	.043	.126	11.33
6006-4504	11NR-18UN	1/4	18	.433	.031	.039	.126	11.33
6006-4508	16NR-8UN	3/8	8	.630	.047	.079	.143	11.33
6006-4510	16NR-10UN	3/8	10	.630	.043	.059	.143	11.33
6006-4511	16NR-11UN	3/8	11	.630	.043	.059	.143	11.33
6006-4512	16NR-12UN	3/8	12	.630	.043	.055	.143	11.33
6006-4513	16NR-13UN	3/8	13	.630	.039	.051	.143	11.33
6006-4514	16NR-14UN	3/8	14	.630	.039	.047	.143	11.33
6006-4516	16NR-16UN	3/8	16	.630	.035	.043	.143	11.33
6006-4518	16NR-18UN	3/8	18	.630	.031	.039	.143	11.33
6006-4524	16NR-24UN	3/8	24	.630	.028	.031	.143	11.33
6006-4528	16NR-28UN	3/8	28	.630	.024	.024	.143	11.33

UN-60° EXTERNAL THREADING & GROOVING CARBIDE INSERTS-Inch Thread

Item#	Insert No.	I.C.	Screw Pitch	S	d	Grade	Price (F)
6006-4108	RT16.01N-8UN	3/8"	8 TPI	5/32"	0.173"	XAF799	14.84
6006-4110	RT16.01N-10UN	3/8"	10TPI	5/32"	0.173"	XAF799	14.84
6006-4112	RT16.01N-12UN	3/8"	12 TPI	5/32"	0.173"	XAF799	14.84
6006-4114	RT16.01N-14UN	3/8"	14 TPI	5/32"	0.173"	XAF799	14.84
6006-4116	RT16.01N-16UN	3/8"	16 TPI	5/32"	0.173"	XAF799	14.84
6006-4118	RT16.01N-18UN	3/8"	18 TPI	5/32"	0.173"	XAF799	14.84
6006-4120	RT16.01N-20UN	3/8"	20 TPI	5/32"	0.173"	XAF799	14.84

RIGHT HAND

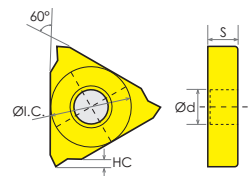

10 PC PER PACKAGE

UN-60° EXTERNAL THREADING & GROOVING CARBIDE INSERTS -Inch Thread

- UN-60° full profile threading insert.
- Tolerance Class: 2A/2B
- TiAlN (TP04) coated .

TiAlN COATED

RIGHT HAND

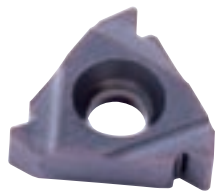
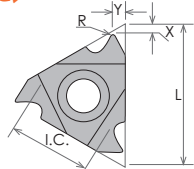

10 PC PER PACKAGE

Item#	Insert	I.C.	Screw Pitch TPI	L (in)	X (in)	Y (in)	Thick (in)	Price (F)
6006-4609	16ER-9UN	3/8	9	.630	.047	.067	.143	11.33
6006-4610	16ER-10UN	3/8	10	.630	.043	.059	.143	11.33
6006-4611	16ER-11UN	3/8	11	.630	.043	.059	.143	11.33
6006-4612	16ER-12UN	3/8	12	.630	.043	.055	.143	11.33
6006-4613	16ER-13UN	3/8	13	.630	.043	.051	.143	11.33
6006-4614	16ER-14UN	3/8	14	.630	.039	.047	.143	11.33
6006-4618	16ER-18UN	3/8	18	.630	.031	.039	.143	11.33
6006-4620	16ER-20UN	3/8	20	.630	.031	.035	.143	11.33
6006-4624	16ER-24UN	3/8	24	.630	.028	.031	.143	11.33
6006-4628	16ER-28UN	3/8	28	.630	.024	.028	.143	11.33
6006-4632	16ER-32UN	3/8	32	.630	.024	.024	.143	11.33

TPMC THREADING INSERTS 10-Degree Rake, Precision Ground

- 60° "V"-threading.
- 10° Rake angle.
- Double countersink thru hole.
- TiN coated.

10 PC PER PACKAGE

Item#	ANSI Insert No.	I.C.	Pitch	Radius R	Thread Degree	Groove Width	Price (F)
6043-1375	TPMC-32NV	3/8	8 TPI Max.	.003~.005	60	.125"	12.15
6043-1500	TPMC-43NV	1/2	6 TPI Max.	.005~.008	60	.187"	15.43
6043-1625*	TPMC-54NV	5/8	4 TPI Max.	.005~.008	60	.250"	16.94

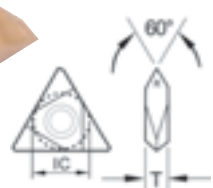

*Limited Supply

THREADING INSERTS

INTERNAL THREADING & GROOVING CARBIDE INSERTS - Metric Thread

Item#	ANSI Insert No.	I.C.	Screw Pitch	S	d	Grade	Price (F)
6006-1006	RT16.01N-1.25GM	3/8"	1.25	5/32"	0.173"	XAF799	14.84
6006-1007	RT16.01N-1.50GM	3/8"	1.50	5/32"	0.173"	XAF799	14.84
6006-1008	RT16.01N-1.75GM	3/8"	1.75	5/32"	0.173"	XAF799	14.84
6006-1009	RT16.01N-2.00GM	3/8"	2.00	5/32"	0.173"	XAF799	14.84
6006-1010	RT16.01N-2.50GM	3/8"	2.50	5/32"	0.173"	XAF799	14.84
6006-1011	RT16.01N-3.00GM	3/8"	3.00	5/32"	0.173"	XAF799	14.84

RIGHT HAND

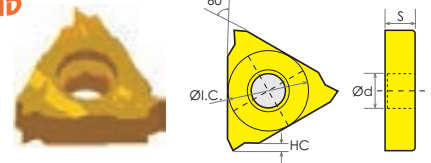

10 PC PER PACKAGE

EXTERNAL THREADING & GROOVING CARBIDE INSERTS - Metric Thread

Item#	ANSI Insert No.	I.C.	Screw Pitch	S	d	Grade	Price (F)
6006-3006	RT16.0W-1.25GM	3/8"	1.25	5/32"	0.173"	XAF799	14.84
6006-3007	RT16.0W-1.50GM	3/8"	1.50	5/32"	0.173"	XAF799	14.84
6006-3008	RT16.0W-1.75GM	3/8"	1.75	5/32"	0.173"	XAF799	14.84
6006-3009	RT16.0W-2.00GM	3/8"	2.00	5/32"	0.173"	XAF799	14.84
6006-3010	RT16.0W-2.50GM	3/8"	2.50	5/32"	0.173"	XAF799	14.84
6006-3011	RT16.0W-3.00GM	3/8"	3.00	5/32"	0.173"	XAF799	14.84

RIGHT HAND

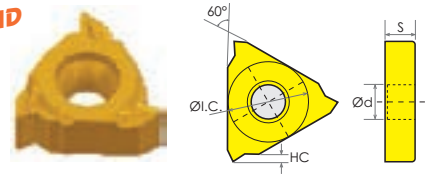

10 PC PER PACKAGE

INTERNAL (NPT) THREADING CARBIDE INSERTS - Pipe Thread

Item#	ANSI Insert No.	I.C.	Screw Pitch	S	d	Grade	Price (F)
6006-6008	RT16.001N-8NPT	.375"	8 TPI	.156"	0.173"	TiN(C6)	14.84
6006-6011	RT16.001N-11.5NPT	.375"	11.5 TPI	.156"	0.173"	XAF799	14.84
6006-6014	RT16.001N-14NPT	.375"	14 TPI	.156"	0.173"	XAF799	14.84
6006-6018	RT16.001N-18NPT	.375"	18 TPI	.156"	0.173"	XAF799	14.84
6006-6027	RT16.001N-27NPT	.375"	27 TPI	.156"	0.173"	XAF799	14.84

RIGHT HAND

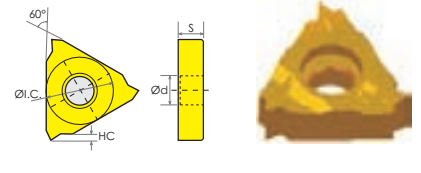

10 PC PER PACKAGE

EXTERNAL (NPT) THREAD CARBIDE INSERTS - Pipe Thread

Item#	ANSI Insert No.	I.C.	Screw Pitch	S	d	Grade	Price (F)
6006-6108	RT16.001W-8NPT	.375"	8 TPI	.156"	0.173"	TiN(C6)	14.84
6006-6111	RT16.001W-11.5NPT	.375"	11.5 TPI	.156"	0.173"	XAF799	14.84
6006-6114	RT16.001W-14NPT	.375"	14 TPI	.156"	0.173"	XAF799	14.84
6006-6118	RT16.001W-18NPT	.375"	18 TPI	.156"	0.173"	XAF799	14.84
6006-6127	RT16.001W-27NPT	.375"	27 TPI	.156"	0.173"	XAF799	14.84

RIGHT HAND

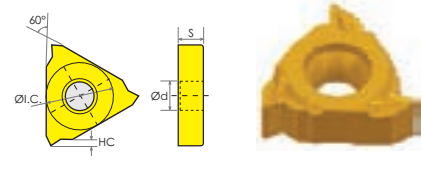

10 PC PER PACKAGE

TNMA THREADING CARBIDE INSERTS 0-Degree Rake, Precision Ground

TNMA

- 60° "V"-threading.
- 0° Rake angle.
- Cylindrical thru hole.

Item#	ANSI Insert No.	I.C.	Pitch	Radius R	Thread Degree	Thick T	Hole d	Grade C6	Price (F)
6043-0375	TNMA-32NV	3/8	8 TPI Max.	.003~.005	60	.125"	.150"	TiN	8.43
6043-0500	TNMA-43NV	1/2	6 TPI Max.	.005~.008	60	.187"	.202"	TiN	13.08
6043-0005	TNMA-43NV	1/2	6 TPI Max.	.005~.008	60	.187"	.202"	Uncoated	10.55

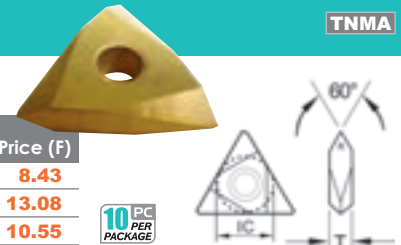

10 PC PER PACKAGE

TNMC GROOVING CARBIDE INSERTS

TNMC

- Right hand on two sides.
- Neutral rake angle.
- Double countersink thru hole.
- TiN coated.

TiN Coated



*Limited Supply

Item#	ANSI Insert No.	Pitch	I.C. (In)	Pitch	Groove Width (In)	Groove Depth (In)	Price (F)
6043-0632	TNMC-32NGR031	8 TPI Max.	0.375	8 TPI Max.	.031	.075	12.15
6043-0633	TNMC-32NGR062	8 TPI Max.	0.375	8 TPI Max.	.062	.150	12.15
6043-0634	TNMC-32NGR094	8 TPI Max.	0.375	8 TPI Max.	.094	.150	12.15
6043-0635	TNMC-32NGR125	8 TPI Max.	0.375	8 TPI Max.	.125	.150	12.15
6043-0643	TNMC-43NGR062	6 TPI Max.	0.500	6 TPI Max.	.062	.125	17.65
6043-0644	TNMC-43NGR094	6 TPI Max.	0.500	6 TPI Max.	.094	.150	17.65
6043-0645	TNMC-43NGR125	6 TPI Max.	0.500	6 TPI Max.	.125	.210	17.65
6043-0646*	TNMC-43NGR156	6 TPI Max.	0.500	6 TPI Max.	.156	.210	14.63
6043-0647*	TNMC-43NGR187	6 TPI Max.	0.500	6 TPI Max.	.187	.210	13.41
6043-0654*	TNMC-54NGR250	4 TPI Max.	0.625	4 TPI Max.	.250	.210	17.82

Carbide grades and insert classification shown on pages 167-170

NOTCH THREADING & GROOVING CARBIDE INSERTS

- Completely interchangeable with the *Kennametal TopNotch and the Teledyne Firth Notch systems.
- 60° Negative rake, natural.
- NT-600 parting profile general purpose threading inserts.
- NG-Grooving & Turning inserts.
- Grade: C5/TIC-65 coated, which is same as KENNAMETAL KC810, KC850, KC950, KC730
- Trademark of Kennametal.

SPECIFICATIONS

Insert #	External TPI	Internal TPI
T/NT-2R/2L	8-36	7-20
T/NT-3R/3L	6-20	5-12
T/NT-4R/4L	4-20	4-12



THREADING INSERTS Grade C5/TIC 65

Item#	Insert #	R	B	(Inch) T	E	A	Gage Dia.	Price (F)
6062-5001	T/NT-2R	.003	.2661	.150	.075	.219	.1875	15.41
6062-5002	T/NT-2L	.005	.2661	.150	.075	.219	.1875	15.41
6062-5003	T/NT-3R	.005	.3999	.195	.098	.344	.3750	15.41
6062-5004	T/NT-3L	.008	.3999	.195	.098	.344	.3750	15.41
6062-5005	T/NT-4R	.005	.6293	.255	.128	.453	.3750	29.21
6062-5006	T/NT-4L	.008	.6293	.255	.128	.453	.3750	29.21

CLAMP

Item #	Style	Price (F)
2100-0011	TNSB-2B	7.15
2100-0010	TNSB-3B	7.15

GROOVING INSERTS Grade C5/TIC 65

R=Right Hand
L=Left Hand

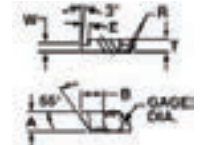

Item#	Insert #	Groove Width			(Inch)Depth of Cut			Gage Dia.	Price (F)
		R	W	B	T	E	A		
6062-2030	T/NG-2031R	.002	.031	.2700	.150	.050	.219	.1875	13.54
6062-2031	T/NG-2031L	.005	.031	.2700	.150	.050	.219	.1875	13.54
6062-2046	T/NG-2047R	.002	.047	.2700	.150	.050	.219	.1875	13.54
6062-2047	T/NG-2047L	.005	.047	.2700	.150	.050	.219	.1875	13.54
6062-2061	T/NG-2062R	.005	.062	.2700	.150	.050	.219	.1875	13.54
6062-2062	T/NG-2062L	.010	.062	.2700	.150	.050	.219	.1875	13.54
6062-2093	T/NG-2094R	.005	.094	.2700	.150	.050	.219	.1875	13.54
6062-2094	T/NG-2094L	.010	.094	.2700	.150	.050	.219	.1875	13.54
6062-2124	T/NG-2125R	.005	.125	.2700	.150	.050	.219	.1875	13.54
6062-2125	T/NG-2125L	.010	.125	.2700	.150	.050	.219	.1875	13.54
6062-3046	T/NG-3047R	.005	.047	.4050	.195	.075	.344	.3750	14.98
6062-3047	T/NG-3047L	.010	.047	.4050	.195	.075	.344	.3750	14.98
6062-3061	T/NG-3062R	.005	.062	.4050	.195	.075	.344	.3750	14.98
6062-3062	T/NG-3062L	.010	.062	.4050	.195	.075	.344	.3750	14.98
6062-3077	T/NG-3078R	.005	.078	.4050	.195	.075	.344	.3750	14.98
6062-3078	T/NG-3078L	.010	.078	.4050	.195	.075	.344	.3750	14.98
6062-3087	T/NG-3088R	.005	.088	.4050	.195	.075	.344	.3750	14.98
6062-3088	T/NG-3088L	.010	.088	.4050	.195	.075	.344	.3750	14.98
6062-3093	T/NG-3094R	.005	.094	.4050	.195	.075	.344	.3750	14.98
6062-3094	T/NG-3094L	.010	.094	.4050	.195	.075	.344	.3750	14.98
6062-3124	T/NG-3125R	.005	.125	.4050	.195	.075	.344	.3750	14.98
6062-3125	T/NG-3125L	.010	.125	.4050	.195	.075	.344	.3750	14.98
6062-3155	T/NG-3156R	.005	.156	.4050	.195	.075	.344	.3750	14.98
6062-3156	T/NG-3156L	.010	.156	.4050	.195	.075	.344	.3750	14.98
6062-3188	T/NG-3189R	.005	.189	.4050	.195	.075	.344	.3750	14.98
6062-3189	T/NG-3189L	.010	.189	.4050	.195	.075	.344	.3750	14.98
6062-4124	T/NG-4125R	.005	.125	.6360	.255	.250	.453	.3750	29.62
6062-4125	T/NG-4125L	.010	.125	.6360	.255	.250	.453	.3750	29.62
6062-4188	T/NG-4189R	.020	.189	.6360	.255	.250	.453	.3750	29.62
6062-4189	T/NG-4189L	.025	.189	.6360	.255	.250	.453	.3750	29.62
6062-4249	T/NG-4250R	0.20	.250	.6360	.255	.250	.453	.3750	29.62
6062-4250	T/NG-4250L	.025	.250	.6360	.255	.250	.453	.3750	29.62

TOP NOTCH STYLE INTERNAL THREADING & GROOVING TOOLHOLDERS

- Right hand.
- Excellent all-purpose system for threading and grooving.
- Very strong insert design and wide insert selection and range.
- Clamping system draws the insert consistently back into the pocket for superior repeatability.
- Fully interchangeable with other similar "notch" type tools and inserts.
- Insert not included.

Right Hand Holder Use Left Hand Inserts



Item#	Holder #	B	C	(Inch)			CLAMP	Screw	Gage Insert Size		Price (F)
				D	F	E			Insert Size	Price (F)	
2301-3010	S10S-TNER2	1.000	10	0.625	.500	TNSN02B	M4X12	2	61.98		
2301-3016	S16T-TNER3	1.375	12	1.000	.688	TNSN-3B	M5X16	3	83.04		
2301-3020	S20U-TNER3	1.750	14	1.250	.875	TNSN-3B	M5X18	3	97.01		
2301-3024	S24U-TNER3	2.000	14	1.500	1.000	TNSN-3B	M5X18	3	122.18		

TOP NOTCH STYLE EXTERNAL THREADING & GROOVING TOOLHOLDERS

- Right hand.
- Excellent all-purpose system for threading and grooving.
- Very strong insert design and wide insert selection and range.
- Clamping system draws the insert consistently back into the pocket for superior repeatability.
- Fully interchangeable with other similar "notch" type tools and inserts.
- Fit notch carbide inserts above.

Right Hand Holder Use Right Hand Inserts

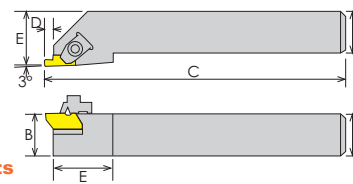

Item#	Holder #	A	B	C	(Inch)			CLAMP	Screw	Gage Insert Size		Price (F)
					D	F	E			Insert Size	Price (F)	
2301-3108	TNSR08-2V	.50	.500	3.5	.138	.75	.75	TNSB-2B	M4x14	2	37.01	
2301-3112	TNSR12-2B	.75	.750	4.5	.138	1.00	.75	TNSB-2B	M4x14	2	43.83	
2301-3113	TNSR12-3B	.75	.750	4.5	.210	1.00	1.25	TNSB-3B	M5x18	3	45.55	
2301-3116	TNSR16-3D	1	1.000	6.0	.210	1.25	1.25	TNSB-3B	M5x18	3	50.21	
2301-3117	TNSR16-4D	1	1.000	6.0	.294	1.25	1.38	TNSB-3B	M5x18	4	52.30	



Insert Not Included

CUT-OFF GROOVING INSERTS & TOOL HOLDERS

MINI-SYSTEM STANDARD CARBIDE GROOVING & CUT-OFF INSERTS

- Grade C6-PV-Coated grade recommended for machining steels, cutting off and grooving at higher speeds.
- Tolerances: Width: +.0009"/-.0000"
- Fits NIKCOLE style mini groove RH tool holders.



GRADE C6-PV

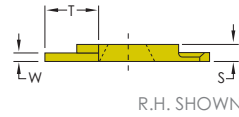

R.H. SHOWN

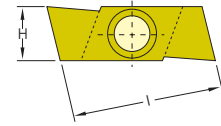

Item#	Insert #	Hand	Depth of Cut	Width of Cut	Price (E)
6061-0300	GIE-7-SG-05	R	.100" (2.54mm)	.019" (0.5mm)	39.22
6061-0301	GIE-7-SG-07	R	.100" (2.54mm)	.027" (0.7mm)	39.22
6061-0302	GIE-7-SG-08	R	.100" (2.54mm)	.031" (0.8mm)	39.22
6061-0303	GIE-7-SG-09	R	.100" (2.54mm)	.035" (0.9mm)	39.22
6061-0304	GIE-7-SG-1.1	R	.235" (6.0mm)	.043" (1.1mm)	39.22
6061-0305	GIE-7-SG-1.3	R	.235" (6.0mm)	.051" (1.3mm)	39.22
6061-0306	GIE-7-SG-1.6	R	.235" (6.0mm)	.063" (1.6mm)	39.22
6061-0307	GIE-7-SG-1.85	R	.235" (6.0mm)	.073" (1.85mm)	39.22

Item#	Insert #	Hand	Depth of Cut	Width of Cut	Price (E)
6061-0311	GIE-7-SG-07	L	.100" (2.54mm)	.027" (0.7mm)	39.22
6061-0312	GIE-7-SG-08	L	.100" (2.54mm)	.031" (0.8mm)	39.22
6061-0313	GIE-7-SG-09	L	.100" (2.54mm)	.035" (0.9mm)	39.22
6061-0314	GIE-7-SG-1.1	L	.235" (6.0mm)	.043" (1.1mm)	39.22
6061-0315	GIE-7-SG-1.3	L	.235" (6.0mm)	.051" (1.3mm)	39.22
6061-0316	GIE-7-SG-1.6	L	.235" (6.0mm)	.063" (1.6mm)	39.22
6061-0317	GIE-7-SG-1.85	L	.235" (6.0mm)	.073" (1.85mm)	39.22

MINI-SYSTEM EXTERNAL GROOVING & CUT-OFF HOLDERS

INSERTS NOT INCLUDED

- Right hand shank external holder.
- Insert not included.
- Set Includes: 1pc- External Holder, 1pc-T10 Wrench, 1pc-Aluminum Case.
- Accepts NIKCOLE style inserts.
- For use with .019 to .125" thin inserts.
- Ideal for external grooving, threading, cut-off, turning & copying under .125" width.

RIGHT HAND HOLDER ONLY ACCEPT RIGHT HAND INSERTS



2306-0375 Shown



2306-0500 Shown



2306-0625 Shown

Item#	Toolholder Designation	Shank Dia (In)	OAL (In)	Use Insert	Screw	Tox Wrench	Price (F)
2306-0375	THE-7-3/8-R	3/8	4.5	GIE-7-SG-	M3x8mm	T10	45.38
2306-0500	THE-7-1/2-R	1/2	4.5	GIE-7-SG-	M3x8mm	T10	49.14
2306-0625	THE-75/8-R	5/8	5.0	GIE-7-SG-	M3x8mm	T10	60.50

GTN-CARBIDE INSERTS

- Self locking inserts.
- Interchangeable with ISCAR & other popular brands.

Insert Style	Insert Size (W) (In)	C-2		C-6		TiN Coated(C-6)	
		Item#	Price (F)	Item#	Price (F)	Item#	Price (F)
GTN-2	.087	3900-5802	4.62	3900-5309	5.17	6024-2002	5.45
GTN-2.4	.094	6024-0002*	4.62	-----	-----	-----	-----
GTN-3	.120	-----	-----	6024-1003	5.00	6024-2003	7.23
GTN-4	.160	6024-0004	5.75	6024-1004	5.35	6024-2004	7.23
GTN-4.8	.187	6024-0008*	4.28	6024-1008*	12.43	6024-2008*	7.23
GTN-5	.200	6024-0005	5.51	6024-1005	5.51	6024-2005	7.65
GTR-4.8	.187	6024-1014*	5.51	6024-1015*	7.16	-----	-----
GTL-4.8	.187	6024-1024*	5.51	-----	-----	6024-2034*	7.23

*Limited Supply

GRADE
C-2 FOR CAST IRON AND GENERAL PURPOSE
C-6 FOR ALL STEEL AND GENERAL PURPOSE
TiN (C-6) FOR INCREASED PRODUCTIVITY



10 PC PER PACKAGE

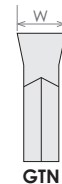

GTN

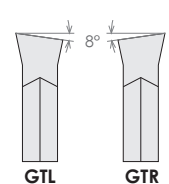

GTL

GTR

CUT-OFF & GROOVING INSERTS

DGN

- Used for applications in parting and grooving.
- Fits ISCAR Heliface, Do-Grip and Groove Turn holders.
- Double ended, two cutting edges.

Limited Supply!

Item#	ANSI Insert No.	(mm) Cutting Width	OAL	r	Grade	Price (F)
6024-5001	DGN2202J	2.2	19.8	0.2	BPG20B-PVD	13.80
6024-5004	DGN3102C	3.1	20.1	0.2	BPS253-CVD	14.47
6024-5014	GRIP4004Y	4.0	19.0	0.4	BPS253-CVD	13.80

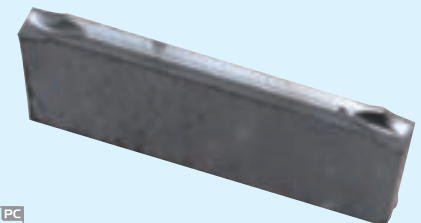

10 PC PER PACKAGE

Carbide grades and insert classification shown on pages 167-170

GROOVING CARBIDE INSERTS

MGMN-G GROOVING CARBIDE INSERTS

MGMN-G

- Specially designed chip breaker allows narrower chips to promote better chip flow.
- Specifically designed for grooving applications.

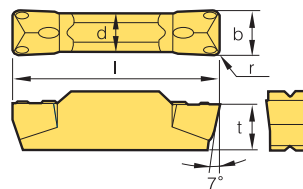

10 PC
PER
PACKAGE

Item#	ANSI Insert No.	Cutting Width b	OAL L	(Inch) d	Cutting Edge Height t	r	Grade	Price (E)
6024-3021	MGMN-150-G	.059	.138	.047	.138	.006	BPS253-CVD	8.67
6024-3022	MGMN-200-G	.079	.138	.063	.138	1/128	BPS253-CVD	5.67
6024-3051	MGMN-200-G	.079	.138	.063	.138	1/128	BPG20B-PVD	5.67

MGMN-M GROOVING CARBIDE INSERTS

MGMN-M

- Specially designed chip breaker allows as moother chip flow versus conventional flattop geometries through the use of a central chip breaker.
- Specially placed convex dots assists twith chip control in external machining, for a smoother chip flow.
- Chip breaker designed for turning , grooving & parting applications.

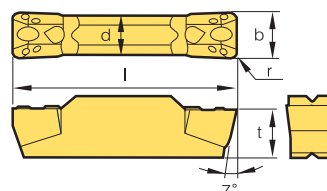

10 PC
PER
PACKAGE

Item#	ANSI Insert No.	Cutting Width	OAL L	(Inch) d	Cutting Edge Height t	r	Grade	Price (F)
6024-3002	MGMN-250-M	.098	.152	.079	.152	1/128	BPS253-CVD	5.78
6024-3003	MGMN-300-M	.118	.189	.093	.189	1/64	BPS253-CVD	5.78
6024-3004	MGMN-400-M	.157	.189	.130	.189	1/64	BPS253-CVD	6.53
6024-3052	MGMN-250-M	.098	.152	.079	.152	1/128	BPG20B-PVD	5.78
6024-3053	MGMN-300-M	.118	.189	.093	.189	1/64	BPG20B-PVD	5.78

MRMN-M GROOVING CARBIDE INSERTS

MRMN-M

- Full radius geometry for applications that require profiling
- Available for relief machining

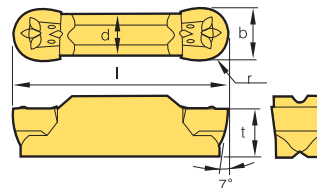

10 PC
PER
PACKAGE

Item#	ANSI Insert No.	Cutting Width b	OAL L	(Inch) d	Cutting Edge Height t	r	PVD Grade	Price (E)
6024-3031	MRMN-200-M	.079	.630	.059	.079	3/64	BPS253	6.57
6024-3032	MRMN-300-M	.118	.827	.093	.118	1/16	BPS253	6.57
6024-3033	MRMN-400-M	.157	.827	.130	.157	5/64	BPS253	6.86
6024-3034	MRMN-500-M	.197	1.024	.161	.197	3/32	BPS253	10.44
6024-3035	MRMN-600-M	.236	1.024	.197	.236	1/8	BPS253	11.66

N123 GROOVING CARBIDE INSERTS

N123E2

- For internal & external grooving.
- For use with Sandvik style holders with V or Rail shape clamp.
- Two cutting edges.

Limited Supply!

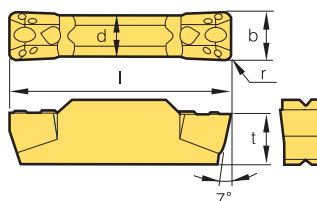
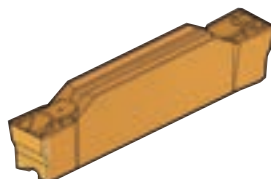

10 PC
PER
PACKAGE

Item#	ANSI Insert No.	(mm) Cutting Width	OAL L	Cutting Edge Height t	r	Grade	Price (F)
6024-4001	N123E2-0200-0004-GF	2	20.05	4.3	0.4	BPS253-CVD	14.47
6024-4002	N123E2-0260-0008-GF	2.6	20.70	4.5	0.8	BPS253-CVD	20.22
6024-4003	N123G2-0318-0008-GF	3.18	20.70	4.5	0.8	BPS253-CVD	14.47

DIGITAL MACHINE SCALES

ELECTRONIC MACHINE SCALES

- Can be installed on almost any surface, offering the user precise linear measurement capability.
- LCD readout with push button control for in/mm conversion
- Absolute zero setting
- Scale body is hardened stainless steel.
- Two mounting brackets are included
- Standard SR 44, 1.55V battery included.
- With fitted case.

Limited Supply!



**INCH/METRIC
.0005" RESOLUTION**

Size	Horizontal Item#	Price (F)	Vertical Item#	Price (F)
12"/300mm	4100-4012	42.31	4100-4042	78.62

STANDARD DIGITAL READOUT SCALES

- Compatible with our LCD Digital Display Units with Mini USB plugs. Not for use with a PC.
- Two mounting brackets are included.
- On/Off button.
- In/mm conversion.
- Absolute zero setting.
- Standard CR2032, 3V battery included.

.0005"/.01MM RESOLUTION



HORIZONTAL

Item#	Size	Accuracy	Price (F)
3129-0216	6"/150mm	±0.0012"/0.03mm	33.90
3129-0218	8"/200mm	±0.0012"/0.03mm	37.55

Limited Supply!

VERTICAL

Item#	Size	Accuracy	Price (F)
3129-0234	4"/100mm	±0.001"/0.02mm	43.25
3129-0236	6"/150mm	±0.0012"/0.03mm	45.67
3129-0240	12"/300mm	±0.0012"/0.03mm	65.27



LCD DIGITAL DISPLAY UNITS

- Remote Digital Display Units for connection to our compatible digital scales with Mini USB Socket.
- Large, easy to read backlit LCD displays, millimetres and Inches.
- Any axis can be set to read Positive or Negative in either direction.
- Fitted with 1.9m long data cables with Mini USB Plug.
- Powered by 2x AAA batteries or 6V DC Power Supply (Both are included).
- Switched Backlight.
- Zero in any position.
- Hold function.
- Magnetic Back.

Display Dimensions:
1 Axis: 104x62x20mm
3 Axis: 130x85x20mm

Item#	Description	Price (F)
3129-0201	1-Axis Display Unit-USB	73.38
3129-0203	3-Axis Display Unit-USB	155.23



Limited Supply!

2 IN 1 DRAWBAR HAMMER/WRENCH

- Hammer head made from brass
- 2 in 1 drawbar tools



3129-0010
\$34.93
(F)
3/4" Hex Shape, OAL: 11.4"

3129-0011
\$33.40
(F)
13mm Hex Shape, OAL: 7-3/4"

QUICK INDEXING QUILL FEED HANDLE

- Speeds up all operations and allows to move the handle into any position.
- For mill with 1" diameter hub.
- Quick flick of wrist retracts index plate pin of quill.
- Spring loaded pin activates quill speed.



1" DIA. HUB

3900-0201
\$28.52
(F)

QUILL STOP

- Increase productivity-reduce cost.
- For Bridgeport, any other mill with 1/2"-20 stop rod.
- Rapid depth setting on quill.
- Fast on-off clip action.
- Rigid clamping.



3900-0200
Shown

MADE IN USA
3900-0199
\$31.04
(F)

3900-0200
\$10.71
(F)

DISPLAY CONSOLE FOR GLASS SCALE ENCODERS

**INCH/METRIC
.0002"/.005MM RESOLUTION**

General Functions:

- Inch/mm Conversion.
- Zero Reset.
- Preset Dimension.
- 1/2 Distance Mode to aid Centre Finding.
- Absolute and Incremental coordinate display modes.
- Recall Memorized Position.
- Mechanical Zero & Workpiece Zero.
- Shrink Function: Shrinkage allowance can be set to compensate for casting or moulding shrinkage.
- Pitch Circle Diameter (PCD) Function: The console will output X and Y coordinates for each hole.

Limited Supply!

**3-Axis Display
3129-0253
\$23374**
(E)

Lathe Functions:

- Tool Compensation and Tool Number.
- Diameter or Radius Reading.

Display Console Specifications:

- Resolution: .0002"/0.005mm (5 Microns).
- Display: 8 Digit LED.
- Response Speed: 60m/min.
- Error: ±1 Count.
- Power: 110-250VAC 50-60Hz.
- Operating Temperature Range: 0-40°C.
- Supplied with mounting arm.
- **Connector: 7 pin DIN (screw locking)**



Calculator Functions:

- Math Functions: Add, Subtract, Multiply, Divide.
- Trig Functions: SIN, COS, TAN, SIN-1, COS-1, TAN-1, X2, v, p (pi).
- Axis position can be transferred to calculator as an operator.
- Result can be transferred back to an axis.

OPTICAL LINEAR SCALES

- Grating Pitch: 0.001"/0.02mm
- Accuracy: ±0.0005"/0.01mm (200C1000mm)
- Reference Marks: 1 ref. mark every 2"/50mm
- Max Traversing Speed: 60m/minute
- Output Signal: TTL
- **Connector: 7 pin DIN (screw locking)**
- Operating Temperature: 0-45°C.

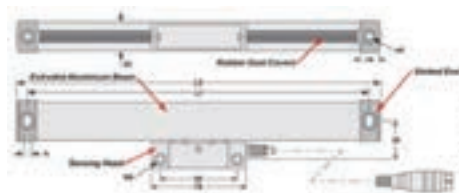

Limited Supply!

IP 53

.0002"/.005MM RESOLUTION

Item#	Size	(mm)		Price (F)
		L1	L2	
3129-0256	6"/150mm	264	281	192.68
3129-0262	12"/300mm	414	431	192.68
3129-0264	14"/350mm	464	481	198.13
3129-0270	16"/400mm	514	531	198.13
3129-0268	20"/500mm	614	631	203.57
3129-0274	30"/800mm	914	931	231.70
3129-0278	35"/900mm	1014	1031	231.70

Pro-Series HEAVY DUTY 150 LBS. POWER TABLE FEEDS

- Complete with all hardware.
- 110V/ 60Hz/ 1 PH power supply.
- Adjustable table speeds.
- 150 lbs torque guaranteed.
- Rapid speed switch.

HHP PRO-SERIES

for Bridgeport® type mills



MADE IN TAIWAN

**Bridgeport BRAND
REQUIRES MODIFICATION**

**X-Axis
(Longitudinal Feed)
3129-0150
\$89238**
(E)

**Y-Axis
(Cross Feed)
3129-0156
\$80520**
(E)

**Z-Axis
(Knee Feed)
3129-0157
\$80520**
(E)

Replacement Plastic Gear (Item #3129-0001).....\$70.40 (E)

QUICK QUILL FEED (Z-Axis) ADAPTER -Driven by Power Drill

- Works with 1/2" power drill speeds up quill (knee) operation function as a power feed
- Fits most mills with 5/8" diameter hub
- Heavy duty made, hardened steel
- Flats cut on shaft for stronger power drill grip

**3129-0015
\$3653**
(F)



MACHINE TOOL ACCESSORIES

MACHINE TOOL ACCESSORIES

Pro-Series R8 RIGHT ANGLE ATTACHMENT KIT

- Suitable for most mills
- Your vertical mill to a horizontal mill
- Designed to simplify right angle work by reducing the need for special tooling and complex fixtures
- For use on your R8 spindle with 3-3/8" overall diameter
- Max. speed: 2000 RPM

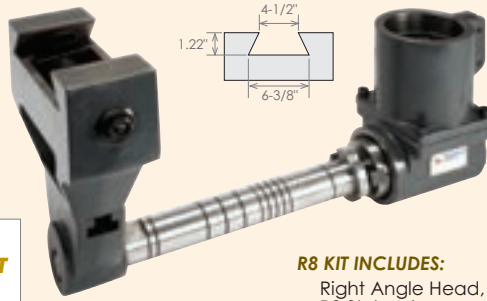

R8 KIT WITH HORIZONTAL SUPPORT
3012-1018
\$1,291⁵⁵
(E)

MADE IN TAIWAN

R8 KIT INCLUDES:
Right Angle Head,
R8 Stub Arbor &
Drawbar Extension
Socket

R8 ANGLE HEAD KIT
3012-1008
\$899⁴⁵
(E)

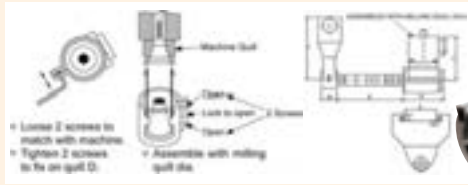

MILLING MACHINE DRAW BARS

for **Bridgeport®** mills

**7/16"~20
THREADER**



Double Life Model

Item#	Description	OAL	Price (C)
3900-0205	For Step Pulley	21-1/8"	15.65
3900-0207	For Variable Speed	24-3/16"	16.88

NEOPRENE MACHINERY LEVELING MOUNTS

- The simplicity of up 5/8" leveling with a single bolt per location while providing shock and vibration isolation solves many problems.
- Friction is developed by the neoprene element.
- Eliminating the need for bolting to the floor.
- Typical applications are punch presses, brakes, shears, lathers, milling machines and injection molding machines.

Limited Supply!

Item#	Capacity (Lbs.)	Steel Cap Dia.(mm)	Height (mm)	Leveling Bolt(mm)	Price (F)
3129-0300	880	50	23	M10x40	27.21
3129-0304	1100	80	24	M10x100	33.26
3129-0308	1320	100	26	M10x120	36.30
3129-0310	2200	120	32	M12x100	42.35
3129-0314	4400	160	37	M16x120	45.36



SPINDLE SQUARE

A SIMPLE SOLUTION T SQUARING YOUR MACHINE

Just zero indicators on flat surface, install in milling machine spindle, bring the spindle down to the table and adjust the head until both indicators read the same. It's that simple!

- 1/2" shank.
- Fully assembled with indicators mounted and ready for use.
- Can also be used with a sine bar or protractor to set angle.
- No more tramming or split reading, compensating for loose worn gears or mirrors.
- Supplied with fitted case

4401-0060
\$235⁰⁵
(E)

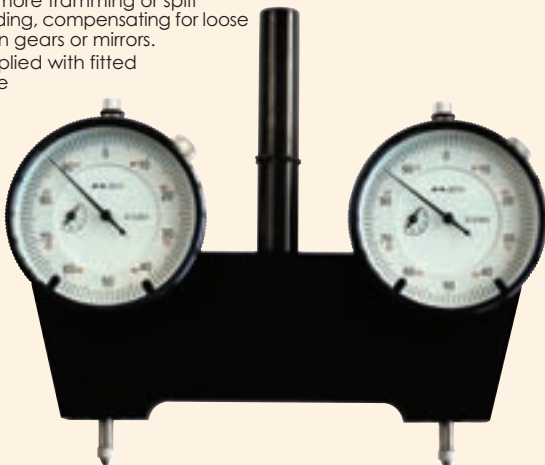

DRILL PRESS CENTER FINDER

- Accurately and quickly locates center on round workpieces
- Satin chrome finish.
- Place tool in drill chuck or collet and line up pointer with line scribed on shaft.

4406-0027
\$57²
(F)

4401-0027
\$266⁶
(E)



CENTER GAGES

- Graduated in 14ths and 20ths on one side and 24ths and 32nds on the other
- Micro-fine graduations
- Accuracy meets Federal Specifications.



Whitworth or English Standard 55°
4901-0061
\$57⁹
(F)



Standard 60°
4901-0060
\$50⁸
(F)



HHP PRO-SERIES
Standard 60°
4901-0059
\$166⁷
(E)

EDGE FINDERS, CENTER FINDERS & SET

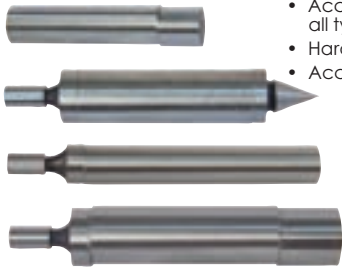

- Accurately locates the starting point for all types of machine work and jig boring
- Hardened and ground all over
- Accuracy .0002"

4PC SET
4401-0048
\$3780
 (F)

INCH

Item#	Style	End	Shank Dia	Tip Dia	Price (F)
4401-0029	Edge & Edge	Double	1/2"	.20/.50"	9.35
4401-0030	Edge	Single	3/8"	0.200"	9.94
4401-0031	Edge	Single	1/2"	0.200"	8.86
4401-0032	Edge	Single	1/2"	0.500"	8.58
4401-0040	Edge & Center	Double	3/8"	0.200"	9.94
4401-0041	Edge & Center	Double	1/2"	0.200"	8.09

METRIC

Item#	Style	End	Shank Dia	Tip Dia	Price (F)
4406-0032	Edge & Center	Double	10mm	4mm	6.60
4406-0042	Edge	Single	12mm	4mm	6.60
4406-0044	Edge	Single	10mm	10mm	6.60

Z TYPE EDGE FINDERS -Metric Shank

- The edge finder is a processing tool used to help accurate positioning. It can locate edges of work pieces with reference to the centerline of the spindle to which it is attached and also height offsets.

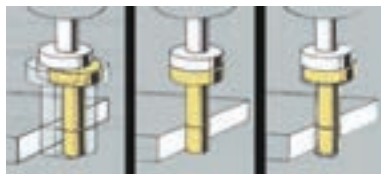
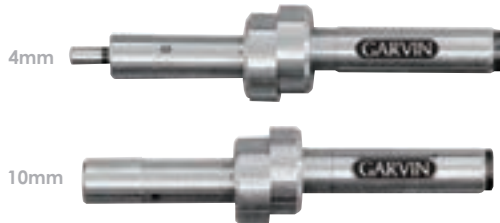

Item#	Shank Dia	Tip Dia	Price (F)
4406-0046	10mm	4mm	11.64
4406-0047	10mm	10mm	11.64

WIGGLER OR CENTER FINDER SET

- The original snap-in ball and socket wiggler
- For accurately locating working points on drill press, milling and other machines

SET INCLUDE:

- Snap-in holder, needle point, disc point & ball shaft

5 PC SET
4401-0045
\$1880
 (E)



ELECTRONIC EDGE FINDERS

- Will locate work surfaces quickly and easily at almost any angle.
- B40 "beeps" when stylus meets conductive metal surface. Great for blind and deep applications.
- All models have 5 LED lights -last for years without replacement.
- 12 V batteries included
- Repeatability +/- .0002"
- Precision ground on all surfaces



Item#	Style	Shank	Stylus Break-Away	Beep	Price (E)
4401-0034	B20	1/2"	.200"	No	187.63
4401-0035	B40	1/2"	.400"	Yes	187.63

ELECTRONIC SHORT SHANK EDGE FINDER

- Quickly locates work edges
- Save time positioning
- One piece construction for strength and accuracy within 0.005mm/ 0.0002"
- Highly visible LED lights
- Precision ground on all surfaces



4401-0038
\$6405
 (E)

SPECIFICATIONS

Ball diameter.....0.394"
 Shank diameter.....0.750"
 Overall length.....3.875"

REPLACEMENT BATTERY SR 44 (ITEM #4102-0030)..\$3.19 (F)

Pro-Series ELECTRONIC EDGE FINDERS

- Will locate work surfaces quickly and easily at almost any angle.
- Red pilot will be lighted when the ball touch the working edge.
- High sensitive positional sensor.
- Supplied with wooden case.
- Battery: 2 x LR1, 1.5V.



MADE IN TAIWAN

* Limited Supply

Item#	Shank	Ball Dia.	OAL	Price (E)
4401-0036	20mm	10mm	6.20"	78.73
4401-0037*	32mm	10mm	6.20"	89.33

Pro-Series ELECTRONIC AUDIBLE EDGE FINDER

- Unit will sound at the same time when the red lamp lights up.
- Accuracy within +/- .005mm/ .0002"
- LED light
- Battery: 1 x UM #5 (12V)



MADE IN TAIWAN

Item#	Shank	Ball Dia.	OAL	Price (E)
4401-0047	3/4"	.394"	6.2"	121.97
4401-0049	20mm	.394"	6.2"	111.02

R8 COLLETS & ACCESSORIES

Pro-Series R8 ROUND COLLET SET

- Guaranteed T.I.R. : < 0.0005" .
- Made of high grade tool steel.
- Hardened and precision ground.
- Internally Threaded: 7/16" -20



13 PC SET
3900-0701
\$150⁸⁷
 (E)

1/8 ~ 7/8 by 16ths

R8 ROUND COLLETS & SETS - Inch

- Made of high grade tool steel.
- Hardened.
- Precision ground to close tolerance.
- Internally threaded: 7/16" -20



11 PC SET
3900-0007
\$83⁹³
 (F)

1/8 ~ 3/4 by 16ths

6 PC SET
3900-0006
\$45⁸⁹
 (F)

1/8 ~ 3/4 by 8ths

7 PC SET
3900-0010
\$57⁶³
 (F)

1/8 ~ 3/4 by 8ths Plus 3/16

23 PC SET
3900-0009
\$169⁷⁸
 (F)

1/16 ~ 3/4 by 32nds

d	L(mm)	Run out
1/32-1/16	6.35	0.0007"
1/16-1/8	12.70	0.0007"
1/8-3/8	25.40	0.0007"
3/8-5/8	38.10	0.0007"
5/8-7/8	50.80	0.0007"



Item#	Size (Inch)	Price (F)	Item#	Size (Inch)	Price (F)
3900-0008	1/16	9.69	3900-0814	1/2	9.76
3900-0801	3/32	9.69	3900-0815	17/32	9.76
3900-0802	1/8	9.76	3900-0816	9/16	9.76
3900-0803	5/32	9.76	3900-0817	19/32	9.76
3900-0804	3/16	9.76	3900-0818	5/8	9.76
3900-0805	7/32	9.76	3900-0819	21/32	9.76
3900-0806	1/4	9.76	3900-0820	11/16	9.76
3900-0807	9/32	9.76	3900-0821	23/32	9.76
3900-0808	5/16	9.76	3900-0822	3/4	9.76
3900-0809	11/32	9.76	3900-0823	25/32	9.76
3900-0810	3/8	9.76	3900-0824	13/16	9.76
3900-0811	13/32	9.76	3900-0825	27/32	9.76
3900-0812	7/16	9.76	3900-0826	7/8	9.76
3900-0813	15/32	9.76	3900-0827	1	20.04

11PC R8 COLLET SET & 12PC R8 COLLET RACK COMBO

NEW

11 Piece R8 Collet Set - 1/8-3/4" x 16ths (3900-0007)

- Hardened and precision ground to close tolerance.
- Made of high grade tool steel.
- Run out is 0.0007".
- Internally threaded: 7/16"-20.



R8 12 Piece Collet Rack (3900-0016)

- Open and close cover protects collets from debris.
- Mounting bolts are included.
- Easy side mount with two screws.

4951-0008
\$90⁰⁹
 (F)

12PC R8 COLLET RACK



HOLDS 12PC R8 COLLETS

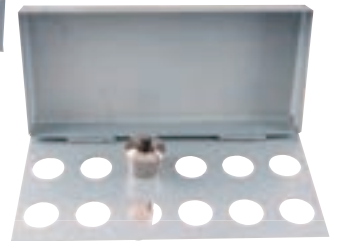

COLLET NOT INCLUDED

3900-0016
\$20⁸⁴
 (F)

- Easy side mount with two screws.
- Open, close cover protects collets from debris.

R8 ROUND COLLETS & SET - Metric

- Made of high grade tool steel.
- Hardened.
- Precision ground to close tolerance.
- Internally threaded: 7/16" -20



10 PC SET
3903-0006
\$83²⁹
 (F)

3, 4, 5, 6, 8, 10, 12, 14, 18, 20mm

Item#	Size (mm)	Price (F)	Item#	Size (mm)	Price (F)
3903-0102	2	9.98	3903-0122	12	8.94
3903-0104	3	10.50	3903-0124	13	8.94
3903-0106	4	8.94	3903-0126	14	8.94
3903-0108	5	8.94	3903-0128	15	8.94
3903-0110	6	8.94	3903-0130	16	8.94
3903-0112	7	8.94	3903-0132	17	8.94
3903-0114	8	8.94	3903-0134	18	8.94
3903-0116	9	8.94	3903-0136	19	8.94
3903-0118	10	8.94	3903-0138	20	8.94
3903-0120	11	8.94			

R8 ROTATING COLLET HOLDER

- Easily mounts anywhere for quick accessibility.
- Hold 11 R8 collets.
- Made of durable ABS material.



3900-1608
(F) **\$3384**

R8 COLLET & TOOL TRAY

- This convenient tray will cut down set up and tool changing time.
- Operator works more organized.
- Easy to install, drill and tap two holes in the base casting 1" below the degree ring.



3900-1601
(E) **\$2263**

Pro-Series R8 END MILL HOLDERS

- Made of 20CrMnTi alloy steel
- Electrolysis nickel coating
- Thread of Drawbar End: R8- 7/16" -20
- Premium hardened & all ground body for extended tool life.



Limited Supply!

MAX. RPM: 8,000
T.I.R. ≤ .0002"
SUPERIOR FINISH

Item#	Size	Price (F)
3901-0100	1/8"	45.36
3901-0101	3/16"	45.36
3901-0102	1/4"	45.36
3901-0103	5/16"	52.25
3901-0105	7/16"	50.42

Item#	Size	Price (F)
3901-0106	1/2"	59.53
3901-0110	7/8"	55.46
3901-0113	1-1/4"	69.45
3901-0114	1-1/2"	83.18

R8 TO JACOBS DRILL CHUCK ARBORS

- Hardened and ground.
- for Bridgeport® type mills
DRAWBAR END THREAD: 7/16" -20



Item#	Arbor Taper to Chuck	D (mm)	L (mm)	Price (F)
3700-0131	R8 to JT33	15.85	132	16.20
3700-0135	R8 to JT2	14.199	128	16.20
3700-0138	R8 to JT3	20.599	137	16.20
3700-0139	R8 to JT4	28.55	148	16.20
3700-0140	R8 to JT6	17.17	132	16.20

48PC R8 COLLET RACK

- Baked enamel paint finish.
- Hangs on wall or machine, or sets on a shelf or work bench.



3900-1605
(E) **\$4227**

COLLETS NOT INCLUDED
HOLDS 48PC R8 COLLETS

R8 END MILL HOLDERS & SETS

- Hardened and ground.
- For Bridgeport type milling machines. DRAWBAR END THREAD: 7/16" -20
- For double and single end mill (single end mill only for sizes over 5/8").



5 PC SET
3900-1005
(F) **\$10394**
3/16, 3/8, 1/2, 5/8, 3/4"

8 PC SET
3900-1008
(F) **\$19065**
3/16, 3/8, 1/2, 5/8, 3/4, 7/8, 1, 1-1/4"

Item#	Size d	Price (F)
3900-0100	1/8"	23.02
3900-0101	3/16"	23.02
3900-0112	1/4"	23.16
3900-1211	5/16"	24.33
3900-0102	3/8"	23.03
3900-0121	7/16"	24.33
3900-0103	1/2"	23.02
3900-0104	5/8"	28.54
3900-0105	3/4"	28.70
3900-0106	7/8"	29.16
3900-0107	1"	30.62
3900-0108	1-1/4"	40.22
3900-0109	1-1/2"	46.26



3PC BORING TOOL COMBO SETS

KIT INCLUDES:
BORING HEAD, SHANK,
C6 CARBIDE TIPPED BORING
BAR SET

- BORING HEAD: Bar holder moves freely and smoothly. Design assures superior rigidity for chatter-free boring and precise hole size accuracy. Hardened and ground adjusting screw designed for long lasting and trouble free use.



Item#	Head Size	Shank Taper	Shank To Head	Boring Bar	Tool Capacity	Price (E)
1001-0105	2"	3MT	7/8"-20	1/2"-9pc	Up to 1/2"	127.71
1001-0106	2"	R8	7/8"-20	1/2"-9pc	Up to 1/2"	132.00
1001-0107	3"	R8	1-1/2"-18	3/4"-12pc	Up to 3/4"	180.03

See page 245 for more heads & sets.

R8 SHANK ER COLLET CHUCKS & TOOLING

R8 SHANK ER COLLET CHUCKS

- Made of high grade tool steel.
- Hardened and precision ground.
- Meets or exceeds Federal specifications.
- **Thread of Drawbar End: 7/16" -20**

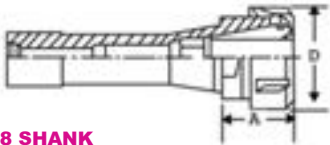

R-8 SHANK

Item#	Type	Nut Style	(Inch) A	D	Price (F)
3900-5061	ER-16	Hex	1.50	1.10	52.74
3900-5066	ER-32	Spanner	1.57	1.97	50.99
3900-5069	ER-40	Spanner	2.76	2.48	54.93



Pro-Series R8 Shank ER Collet Chucks

- Premium hardened & all ground body for extended tool life.
- **Thread of Drawbar End: R8- 7/16" -20**

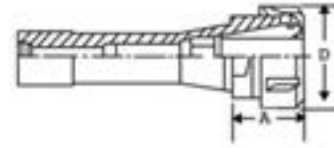

**T.I.R. ≤ .0002"
SUPERIOR FINISH**

Item#	No.	Nut Style	(Inch) A	D	Price (F)
3901-5061	ER-16	Hex	1.50	1.10	84.17
3901-5063	ER-20	Hex	1.50	1.38	99.82
3901-5064	ER-25	Spanner	1.57	1.66	91.50
3901-5066	ER-32	Spanner	1.57	1.97	114.37
3901-5069	ER-40	Spanner	2.76	2.48	99.82



R8 SHANK ER SPRING COLLET CHUCK SETS

- High precision collet chuck system suitable for all milling and drilling applications.
- Unique self-releasing system.
- Wide holding range.
- With fitted case.
- Accuracy to .0005".

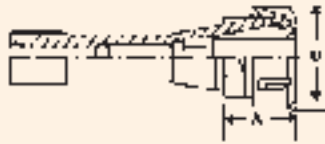

R-8 SHANK

ER-16	ER-32	ER-40
• 11PC SET INCLUDES 9-Collet 1/16, 3/32, 1/8, 3/16, 7/32, 1/4, 5/16, 11/32 & 3/8" 1-Collet Chuck 1-Wrench 1-Wrench	• 8PC SET INCLUDES 6-Collet 1/4, 5/16, 3/8, 1/2, 5/8 & 3/4" 1-Collet Chuck 1-Wrench • 14PC SET INCLUDES 12-Collet 1/16, 3/32, 1/8, 3/16, 1/4, 5/16, 3/8, 7/16, 1/2, 9/16, 5/8 & 13/16" 1-Collet Chuck 1-Wrench	• 10PC SET INCLUDES 8-Collet 1/8, 1/4, 3/8, 1/2, 5/8, 3/4, 7/8 & 1" 1-Collet Chuck 1-Wrench • 17PC SET INCLUDES 15-Collet 1/8, 3/16, 1/4, 5/16, 3/8, 7/16, 1/2, 9/16, 5/8, 11/16, 3/4, 13/16, 7/8, 15/16 & 1" 1-Collet Chuck 1-Wrench



Item#	No.	Nut Style	Collet Set (Inch) A	D	Drawbar Thread	Price (E)	
3900-0501	ER-16	Hex	11	1.50	1.10	7/16-20	156.03
3900-0507	ER-32	Spanner	8	1.57	1.97	7/16-20	126.46
3900-0508	ER-32	Spanner	14	1.57	1.97	7/16-20	187.69
3900-0004	ER-40	Spanner	10	2.76	2.48	7/16-20	127.23
3900-0005	ER-40	Spanner	17	2.76	2.48	7/16-20	208.68

R8 INTEGRAL SHANK PRECISION KEYLESS DRILL CHUCKS

- Integrated design maximizes rigidity & accuracy.
- Integral R8 shank is more compact than a combined drill chuck and arbor and eliminates the chuck slipping on its arbor.
- Keyless, self tightening design.

R-8 SHANK



T.I.R. ≤ .0025"

Item#	Clamping Capacity	Brand	Origin	T.I.R.	Price (F)
3701-1501	0~1/2"	HHIP	China	.0025"	120.58
3701-1626	1/64~5/8"	HHIP	China	.0025"	135.36



Max. T.I.R. ≤ .002"



Item#	Clamping Capacity	Brand	Origin	T.I.R.	Price (F)
3701-1500	0~1/2"	VERTEX	Taiwan	.0020"	215.53
3701-1625	1/8~5/8"	VERTEX	Taiwan	.0020"	232.03

* Tightening Wrench Included.

R8 SHELL END MILL HOLDERS

- Hardened and ground.
- DRAWBAR END THREAD: 7/16" -20**

for **Bridgeport®** type mills



5 PC SET
3900-1710
\$255.75
(E)
1/2, 3/4, 1, 1-1/4, 1-1/2"

Shell end mill holder screws shown on pages 222.

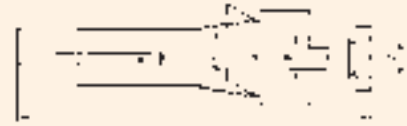

INDIVIDUALS

Item#	d	W (mm)	L (mm)	Dia. Range of Std. End Mill	Price (F)
3900-1711	1/2"	6.35	150	1-1/4 to 1-1/2"	50.16
3900-1712	3/4"	7.94	154	1-1/4 to 2-1/2"	50.47
3900-1713	1"	9.53	155	2-1/4 to 2-3/4"	58.38
3900-1714	1-1/4"	12.70	156	3 to 3-1/2"	62.71
3900-1715	1-1/2"	15.88	163	4 to 5"	68.88

STRAIGHT SHANK STUB MILLING MACHINE ARBORS

- Fit into standard end mill adapters
- Furnished with standard keyways and left hand arbor nut

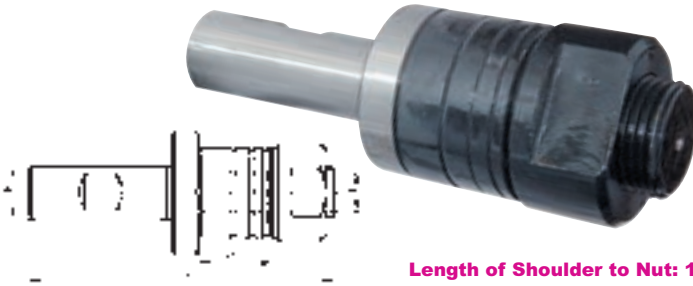

Length of Shoulder to Nut: 1"

Item#	Shank d1 (Inch)	Dia. of Arbor d (Inch)	L (Inch)	Price (F)
3900-0156	1/2	1/2	4.0	51.72
3900-0157	1/2	5/8	4.0	55.01
3900-0158	1/2	3/4	4.2	62.36
3900-0159	3/4	1/2	4.3	50.82
3900-0161	3/4	3/4	4.4	62.63
3900-0162	3/4	7/8	4.4	66.95
3900-0163	3/4	1	4.7	71.84
3900-0164	3/4	1-1/4	4.7	75.68
3900-0115	1	3/4	4.7	61.79
3900-0116	1	1	5.6	76.64

STUB MILLING MACHINE ARBORS

for **Bridgeport®** type milling machines

- Hardened and precision ground.

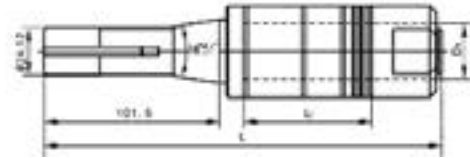

Item#	Shank	Dia. of Arbor	Length Shoulder to Nut	Price (F)
3900-0110	R8	1"	2"	70.30
3900-0111	R8	1-1/4"	2"	72.09

SLOTING SAW ARBORS

- For saw blades upto 3/16" thick



3900-0144 Shown

3900-0145 Shown

Item#	Shank	OAL	For Saw Hole Size	Price (F)
3900-0144	R8	5-3/32"	1/2, 5/8, 3/4, 7/8 & 1"	30.92
3900-0145	1/2"	2-9/16"	1/2, 5/8, 3/4, 7/8 & 1"	20.76

CIRCULAR SAW ARBORS

- 1/2" SHANK
- Up to 3/16" thickness
- Steel, heat treated shank



3 PC SET
3900-0150
\$175.4
(F)
1/4, 3/8, 1/2" Hole Sized

INDIVIDUALS

Item#	OD Flange	For Saw Hole Size	Price (F)
3900-0147	1/2"	1/4"	6.56
3900-0148	5/8"	3/8"	9.29
3900-0149	3/4"	1/2"	9.74

MORSE TAPER TOOLING

R8 TO MORSE TAPER SLEEVES

- Made of high grade tool steel.
- Hardened and precision ground.



Thread of Drawbar End:
R8- 7/16" -20

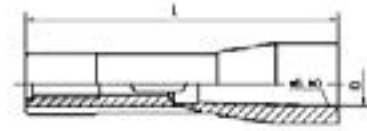

Item#	Description	D (mm)	L (mm)	Price (F)
3900-1812	R8 to MT2	17.78	127	20.01
3900-1813	R8 to MT3	23.825	153	20.52
3900-1814	R8 to MT4	31.267	240	24.18

MORSE TAPER COLLETS & SETS

- Morse taper: external.
- Made of high grade tool steel.
- Hardened and precision ground to close tolerance.



Drawbar End Threads:
MT2: 3/8" ~ 16
MT3: 3/8" ~ 16

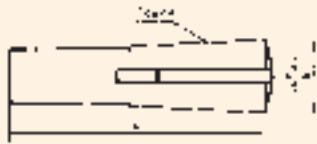

MT3, 7PC SET
3900-0893
\$9870
(F)

1/8" - 3/4" x 8THS & 3/16"

MT2, 7PC SET
3900-0850
\$8285
(F)

1/8" - 1/2" x 16THS

MT3 SHANK

Item#	Hole Dia. D	(mm) L	Price(F)
3900-0855	1/8"	24.1 86	15.76
3900-0859	3/16"	24.1 86	15.76
3900-0863	1/4"	24.1 86	15.76
3900-0865	5/16"	24.1 86	15.76
3900-0867	3/8"	24.1 86	15.76
3900-0875	7/16"	24.1 86	15.76
3900-0883	1/2"	24.1 86	15.76
3900-0887	5/8"	24.1 86	15.76
3900-0889	11/16"	24.1 86	15.76
3900-0891	3/4"	24.1 86	15.76

MT2 SHANK

Item#	Hole Dia. D	(mm) L	Price(F)
3900-0837	1/8"	18 68	13.90
3900-0839	3/16"	18 68	13.90
3900-0841	1/4"	18 68	13.90
3900-0843	5/16"	18 68	13.90
3900-0845	3/8"	18 68	13.90
3900-0847	7/16"	18 68	13.90
3900-0849	1/2"	18 68	13.90

MORSE TAPER (MT) SLEEVES

- Used to convert spindles to larger or smaller tapers and extend the spindles of drill presses, radial drills, boring mills and turret lathes.



INDIVIDUALS

Item#	Inside Taper	Outside Taper	Price(F)
3900-1843	MT1	MT2	8.33
3900-1841	MT1	MT3	12.24
3900-1842	MT2	MT3	12.24
3900-1844	MT2	MT4	13.28
3900-1848	MT3	MT4	13.78
3900-1849	MT3	MT5	24.44
3900-1853	MT4	MT5	26.93
3900-1856	MT5	MT6	49.71

4 PC SET
3900-1850
\$5844
(F)

MT1-MT2, MT2-MT3, MT3-MT4, MT4-MT5

MORSE TAPER DRILL CHUCK ARBORS



HARDENED & GROUND

MT TO JT

Item#	Arbor Taper to Chuck	Price (F)
3700-0111	MT1 to JT0	8.48
3700-0112	MT1 to JT1	8.49
3700-0113	MT1 to JT33	8.49
3700-0115	MT2 to JT1	8.34
3700-0151	MT2 to JT2	11.12
3700-0149	MT2 to JT3	11.33
3700-0117	MT2 to JT4	8.49
3700-0150	MT2 to JT6	11.12
3700-0152	MT2 to JT33	11.12
3700-0153	MT3 to JT33	12.11
3700-0154	MT3 to JT2	15.31

Item#	Arbor Taper to Chuck	Price (F)
3700-0155	MT3 to JT3	12.11
3700-0159	MT3 to JT4	11.63
3700-0156	MT3 to JT6	12.11
3700-0160	MT4 to JT3	16.20
3700-0161	MT4 to JT4	16.20
3700-0157	MT4 to JT33	15.20
3700-0120	MT4 to JT5	16.20
3700-0158	MT4 to JT6	16.17
3700-0123	MT5 to JT3	28.16
3700-0124	MT5 to JT4	29.38

Pro-Series DAYTON STYLE HAND DRIFT TOOL

- Forged and hardened, high rigid tools.
- Used to remove taper shank tools from machinery spindles, sleeves, and extension sockets.
- Morse Taper Drift Range: MT2 ~ MT5

15" LONG



Range MT2-MT5
3900-0267
\$5650
(F)

MADE IN TAIWAN



MORSE TAPER EXTENSION SOCKETS

- For adapting tools with morse taper shanks to machines having smaller, same or larger morse taper spindle.



Item#	Inside Taper	Outside Taper	Price (F)
3900-1845	MT3	MT2	29.63
3900-1852	MT4	MT3	48.97
3900-1872	MT5	MT4	73.41

MORSE TAPER END MILL HOLDERS

- For single end mills.
- **Drawbar End Thread**
MT2- 3/8" - 16
MT3- 3/8" - 16
MT4- 1/2" - 13



Item#	Shank Taper	Hole Dia.	Price (F)	Item#	Shank Taper	Hole Dia.	Price (F)
3900-1217	MT2	3/16"	27.73	3900-0130	MT3	5/8"	30.95
3900-1212	MT2	1/4"	28.87	3900-0131	MT3	3/4"	38.97
3900-1215	MT2	3/8"	27.73	3900-0132	MT3	7/8"	36.04
3900-1214	MT2	1/2"	31.45	3900-0133	MT3	1"	37.95
3900-0127	MT3	3/16"	24.66	3900-0140	MT4	1"	40.66
3900-0128	MT3	3/8"	26.67	3900-0141	MT4	1-1/4"	48.05
3900-0129	MT3	1/2"	28.38	3900-0142	MT4	1-1/2"	56.70

MT SHANK ER COLLET CHUCKS

- Made of high grade tool steel.
- Hardened and precision ground.
- Meets or exceeds Federal specifications.

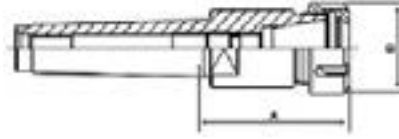

Item#	Shank Type	Nut Style	Drawbar End	A (mm)	D (mm)	Price(F)
3900-5072	MT2	ER-20	Hex	3/8"~16	43	34 46.40
3900-5073	MT2	ER-25	Spanner	3/8"~16	47	42 63.87
3900-5077	MT3	ER-32	Spanner	3/8"~16	70	50 50.22
3900-5078	MT3	ER-40	Spanner	3/8"~16	80	63 61.64
3900-5079	MT4	ER-40	Spanner	5/8"~11	82	63 68.24



MORSE TAPER ER SPRING COLLET CHUCK SETS

- High precision collet chuck system suitable for all milling and drilling applications.
- Unique self-releasing system.
- Wide holding range.
- With fitted case.
- Accuracy to .0005".

ER-25	ER-32	ER-40
12PC SET INCLUDES 10-Collet 3/32, 1/8, 3/16, 1/4, 5/16, 3/8, 7/16, 1/2, 9/16 & 5/8" 1-Collet Chuck 1-Wrench	14PC SET INCLUDES 12-Collet 1/16, 3/32, 1/8, 3/16, 1/4, 5/16, 3/8, 7/16, 1/2, 9/16, 5/8 & 13/16" 1-Collet Chuck 1-Wrench	17PC SET INCLUDES 15-Collet 1/8, 3/16, 1/4, 5/16, 3/8, 7/16, 1/2, 9/16, 5/8, 11/16, 3/4, 13/16, 7/8, 15/16 & 1" 1-Collet Chuck 1-Wrench

Item#	No.	Chuck Shank	Nut Style	Set	Price (E)
3900-0502	ER-25	MT2	Spanner	12	149.21
3900-0503	ER-32	MT3	Spanner	14	160.86
3900-0531	ER-40	MT3	Spanner	17	204.19
3900-0504	ER-40	MT4	Spanner	17	198.14

- **Drawbar End Thread**
MT2- 3/8"~16
MT3- 3/8"~16
MT4- 1/2"~13



Pro-Series ER MORSE TAPER COLLET CHUCKS & SETS

- Made of high grade tool steel Morse Tapper shank high precision collet chuck system.
- Hardened & ground body for extended tool life.
- With fitted case.
- Chuck T.I.R. to .0002".



3900-4050 Shown

3900-4052 Shown



Limited Supply!

3900-4050	3900-4052
12PC SET INCLUDES 10-ER-25 Collet 3/32, 1/8, 3/16, 1/4, 5/16, 3/8, 7/16, 1/2, 9/16 & 5/8" 1-MT2 Collet Chuck 1-Spanner Wrench	14PC SET INCLUDES 12-ER-32 Collet 1/16, 3/32, 1/8, 3/16, 1/4, 5/16, 3/8, 7/16, 1/2, 9/16, 5/8 & 13/16" 1-MT3 Collet Chuck 1-Spanner Wrench

3900-4054	3900-4056
17PC SET INCLUDES 15-ER-40 Collet 1/8, 3/16, 1/4, 5/16, 3/8, 7/16, 1/2, 9/16, 5/8, 11/16, 3/4, 13/16, 7/8, 15/16 & 1" 1-MT3 Collet Chuck 1-Spanner Wrench	17PC SET INCLUDES 15-ER-40 Collet 1/8, 3/16, 1/4, 5/16, 3/8, 7/16, 1/2, 9/16, 5/8, 11/16, 3/4, 13/16, 7/8, 15/16 & 1" 1-MT4 Collet Chuck 1-Spanner Wrench

Item#	Type	Chuck Shank	No. of Pieces	Nut Style	Nut Dia. D	Gage Length A	Drawbar End	Price (E)
3900-4050	ER-25	MT2	12	Spanner	1.7"	2.50"	3/8"-16	183.33
3900-4052	ER-32	MT3	14	Spanner	2.0"	2.75"	3/8"-16	226.26
3900-4054	ER-40	MT3	17	Spanner	2.5"	3.20"	3/8"-16	289.48
3900-4056	ER-40	MT4	17	Spanner	2.5"	3.20"	5/8"-11	292.82

MORSE TAPER TOOLING

FLY CUTTERS-Morse Taper Shank

- A fly cutter usually has two cutting heads and it is able to cut with a constant depth to face any surface to obtain a uniform surface.
- Utilizes standard tool bits.
- Counter balanced.
- Made of durable hardened steel.



Item#	Shank	Diameter of Head (in)	Fit Tool Bit (in)	Drawbar Thread	Price (F)
4006-0022	MT2	1.5	3/16	3/8~16	25.96
4006-0023	MT3	1.5	1/4	1/2~13	29.21

Tool bits shown on page 120

MORSE TAPER TAILSTOCK DIE HOLDER SETS

- The set includes tapered Shank, Pin Punch & 4 sizes of Die Holders.
- Completely interchangeable to fit tapered shank with the help of a pin which allows about 1-1/2" travel.
- Easy knock out pin with a pin punch.
- Tang end.



Item#	Taper	Die Holder Size	Price (F)
3906-4910	MT 2	13/16, 1-1/8 & 1-1/2"	57.36
3906-4911	MT 3	13/16, 1-1/8 & 1-1/2"	61.78

MT TO JT REVOLVING TAILSTOCK ARBORS/ADAPTERS

- Use to support small diameter work where a live center is not practical.
- This is a "live" adapter with smooth, sealed bearings for the tailstock.
- Use it to mate with any Jacob Taper (JT) drill chuck.
- The shank is Morse taper (MT).



MT2 x JT2
3906-4922
\$ **42.14**
(F)

* Drill Chuck Not Included

Item#	Taper	Drawbar Thread	Price (F)
3906-4922	MT 2 x JT2	M10	42.14
3906-4925	MT2 x JT3	M10	42.14
3901-4910	MT2 x JT33	M10	89.06
3906-4928	MT3 x JT2	M12	42.14
3906-4932	MT3 x JT3	M12	42.14

INTEGRAL SHANK PRECISION KEYLESS DRILL CHUCKS

- Integrated design maximizes rigidity & accuracy.
- Integral shank is more compact than a combined drill chuck and arbor and eliminates the chuck slipping on its arbor.
- Keyless, self tightening design.

Item#	Brand	Morse Taper	Clamping Capacity	T.I.R.	Origin	Price (F)
3701-2490	HHIP	2	1/64~5/16"	.0025"	CHINA	88.85
3701-2499	HHIP	3	1/64~1/2"	.0025"	CHINA	113.38
3701-2502	HHIP	4	1/64~1/2"	.0025"	CHINA	103.93
3701-2624	HHIP	3	1/64~5/8"	.0025"	CHINA	127.78
3701-2627	HHIP	4	1/64~5/8"	.0025"	CHINA	117.13



HHIP PRO-SERIES
T.I.R. ≤ .0025"



VERTEX
T.I.R. ≤ .0020"

Item#	Brand	Morse Taper	Clamping Capacity	T.I.R.	Origin	Price (F)
3701-2500	VERTEX	3	0~1/2"	.0020"	Taiwan	163.53
3701-2501	VERTEX	4	0~1/2"	.0020"	Taiwan	174.35
3701-2625	VERTEX	3	1/8~5/8"	.0020"	Taiwan	174.35
3701-2626	VERTEX	4	1/8~5/8"	.0020"	Taiwan	182.67

* Vertex Hook Tightening Wrench Included

SCHAUBLIN STYLE LATHE COLLETS

- Made of high quality tool steel
- Hardened and precision ground to highest concentricity.
- These collets are closed by being drawn back into the collet seating by means of a draw bar.
- The W10 collets differ from the other pull-type collets because of their external thread, which has a nominal diameter almost identical to the collet shank diameter.
- The collets only open a minimal amount.



- The pull-type collets generally only clamp the nominal diameter.
- To obtain optimal concentricity, it is recommended not to clamp less than 0.1 mm below the nominal diameter.

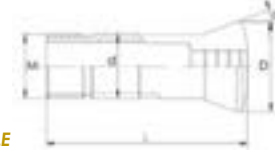

W10 STYLE

Item#	Size D	Price (F)
3900-4965	3/32"	6.34
3900-4966	7/64"	6.34
3900-4967	1/8"	6.34
3900-4968	9/64"	6.34
3900-4969	5/32"	6.34
3900-4970	11/64"	6.34

Item#	Size D	Price (F)
3900-4971	3/16"	6.34
3900-4972	13/64"	6.34
3900-4973	7/32"	6.34
3900-4974	15/64"	6.34
3900-4975	1/4"	6.34

W20 STYLE

Item#	Size	Sale (F)
3903-0804	4mm	27.57
3903-0805	5mm	27.57
3903-0806	5.5mm	27.57
3903-0808	6mm	27.57
3903-0809	6.5mm	27.57
3903-0812	7mm	27.57
3903-0815	8mm	27.57
3903-0816	10mm	27.57
3903-0818	12mm	27.57
3903-0822	14mm	27.57

Item#	Size	Sale (F)
3903-0904	1/8"	27.57
3903-0906	3/16"	27.57
3903-0908	1/4"	27.57
3903-0910	5/16"	27.57
3903-0912	3/8"	27.57
3903-0914	7/16"	27.57
3903-0916	1/2"	27.57
3903-0918	9/16"	27.57

DIMENSIONS

Style	Type	D	d	Thread M	α	L
W10	Inch	14mm	9mm	M8.74X0.833	15°	50mm
W20	Inch	1.036"	.7874	M19.7x1.666	15°	2.874"
W20	Metric	26.3mm	20mm	M19.7x1.666	15°	73mm

Brown & Sharpe TAPER ROUND COLLETS

- Made of high grade tool steel.
- Precision ground and hardened.

DIMENSIONS

Taper	A	B	L	Drawbar End
#7	0.725"	0.600"	3.00"	3/8"~16
#9	1.067"	0.900"	4.00"	1/2"~13



≤ .0008" TIR

#7 TAPER COLLETS

Item#	Size	Price (E)
3900-0970	1/8"	19.29
3900-0972	3/16"	19.29
3900-0973	1/4"	19.29
3900-0974	5/16"	19.29
3900-0975	3/8"	19.29
3900-0976	7/16"	19.29
3900-0977	1/2"	19.29

#7, 7 PC SET
3900-0979
\$12352
 (E)
 1/8 ~ 1/2 by 16ths

#9, 11 PC SET
3900-0985
\$20757
 (E)
 1/8 ~ 3/4 by 16ths

#9 TAPER COLLETS

Item#	Size	Price (E)
3900-0989	1/8"	23.28
3900-0990	3/16"	23.28
3900-0991	1/4"	23.28
3900-0992	5/16"	23.28
3900-0993	3/8"	23.28
3900-0994	7/16"	23.28
3900-0995	1/2"	23.28
3900-0996	9/16"	23.28
3900-0997	5/8"	23.28
3900-0998	11/16"	23.28
3900-0999	3/4"	23.28

Pro-Series HSK FACE MILL HOLDERS

- Blanced to G2.5, 25,000 RPM.
- Made from high grade alloy steel.

Limited Supply!

MADE IN TAIWAN

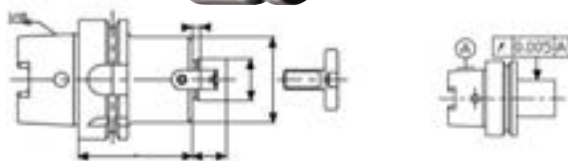

Item#	Taper	Bore Dia.	Projection Gage Line to Nose End	Price (E)
3901-6040	HSK63A	1"	60mm	286.19
3901-6044	HSK63A	1-1/4"	60mm	224.22
3901-6048	HSK63A	1-1/2"	60mm	254.80

Pro-Series HSK ER COLLET CHUCKS

- Blanced to G2.5, 25,000 RPM.
- Made from high grade alloy steel.

MADE IN TAIWAN



Limited Supply!

Item#	Taper	Collet Series	Projection Gage Line to Nose End	OAL	Price (E)
3901-6010	HSK63A	ER-32	80mm	112mm	232.75
3901-6030	HSK100A	ER-32	100mm	150mm	497.95

NMTB TOOLING

NMTB 30 & 40 TAPER TO JACOBS ARBORS

- Hardened and precision ground.

Jacob Taper	Taper 30 Item#	Price (F)	Taper 40 Item#	Price (F)
JT2	3900-1762	40.12	3900-1772	49.50
JT3	3900-1763	40.87	3900-1773	46.80
JT33	3900-1764	43.25	3900-1774	46.80
JT6	3900-1766	43.25	3900-1776	46.80

Drawbar End:
#30- 1/2" -13
#40- 5/8" -11



NMTB 30 & 40 TAPER END MILL HOLDERS

- For milling machines having 30-40 standard taper spindles.
- Hardened and precision ground.
- Accepts single and double end mills. (single end mill only for sizes over 7/8").



Drawbar End:
#30- 1/2" -13
#40- 5/8" -11

Bore A	Taper 30 Item#	B	C	Price (F)	Taper 40 Item#	B	C	Price (F)
3/16	3900-1690	1.75"	0.75"	44.70	3900-1700	2.31"	0.75"	49.56
1/4	3900-1683	1.75"	0.79"	46.26	3900-1718	2.31"	0.79"	49.56
5/16	3900-1691	1.75"	0.87"	46.26	3900-1701	2.31"	0.87"	49.56
3/8	3900-1692	1.75"	1.00"	45.71	3900-1702	2-5/16	1	49.56
1/2	3900-1693	1.75"	1.38"	45.71	3900-1703	2-5/16	1-3/8	49.56
5/8	3900-1694	1.75"	1.43"	46.88	3900-1704	2-5/16	1-5/8	49.56
3/4	3900-1695	2.25"	1.89"	46.88	3900-1705	2-5/16	1-7/8	54.10
7/8	3900-1696	2.50"	2.01"	46.88	3900-1706	3.19"	1.93"	55.23
1	3900-1697	2.69"	2.36"	48.09	3900-1707	2-11/16	2	55.23
1-1/4	3900-1698	3.62"	2.48"	49.43	3900-1708	2-29/32	2-3/8	55.23
1-1/2					3900-1709	3.95"	2.99"	61.80
2					3900-2711	3.95"	4.95"	75.60

NMTB 30 & 40 TAPER SHELL END MILL HOLDERS

- For shell end mills and indexable face mills.
- Heat treated and precision ground.
- Perfectly concentric to prevent runoff of your cutting tools.

Drawbar End: #30- 1/2" -13
#40- 5/8" -11

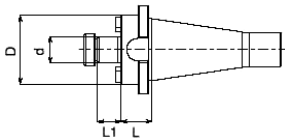

Bore d	Taper 30 Item#	L (Inch)	D (Inch)	L1	Price (F)	Taper 40 Item#	L (Inch)	D (Inch)	L1	Price (F)
3/4"	3900-0742	1.31	1.93	0.67	77.07	3900-1742	0.87	1.93	0.67	72.00
1"	3900-0743	1.31	2.38	0.67	77.07	3900-1743	1.31	2.38	0.67	72.00
1-1/4"	3900-0744	1.44	2.88	0.67	80.42	3900-1744	1.50	2.88	0.67	99.00
1-1/2"	3900-0745	2.00"	3.00"	0.94	84.03	3900-1745	2.00"	3.00"	0.94"	99.00
2"	3900-0746	2.50"	3.86	0.94	99.22	3900-1746	2.50"	3.86"	0.94"	99.00

Pro-Series NMTB 30 & 40 SHANK ER COLLET CHUCKS

- Tolerance: .0003" Max.

SUPERIOR FINISH & CRAFTSMANSHIP

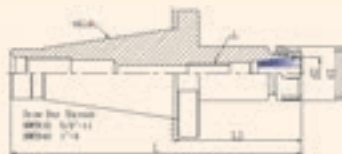

Item#	Shank	Type	Nut Style	L	(mm) L1	d1	Drawbar End	Price (F)
3901-5083	#30	ER-32	Spanner	128.4	60	50	1/2"~13	95.83
3901-5084	#30	ER-40	Spanner	138.4	70	63	1/2"~13	102.22
3901-5088	#40	ER-16	Hex	138.4	45	28	5/8"~11	93.70
3901-5090	#40	ER-32	Spanner	153.4	60	50	5/8"~11	102.22
3901-5091	#40	ER-40	Spanner	163.4	70	63	5/8"~11	111.79

NMTB 30 & 40 SHANK ER COLLET CHUCKS

- Made of high grade tool steel.
- Hardened and precision ground.
- Meets or exceeds Federal specifications.



Item#	Shank	Type	Nut Style	Drawbar End	Price (F)
3900-5083	#30	ER-32	Spanner	1/2"~13	63.06
3900-5084	#30	ER-40	Spanner	1/2"~13	61.90
3900-5088	#40	ER-16	Hex	5/8"~11	59.17
3900-5090	#40	ER-32	Spanner	5/8"~11	70.26
3900-5091	#40	ER-40	Spanner	5/8"~11	63.71

NMTB 30 & 40 TAPER ER COLLET CHUCK SETS

- High precision collet chuck system suitable for all milling and drilling applications.
- Unique self-releasing system.
- Wide holding range.
- With fitted case.
- Accuracy to .0005".

ER-32	ER-40
• 14PC SET INCLUDES 12-Collet 1/16, 3/32, 1/8, 3/16, 1/4, 5/16, 3/8, 7/16, 1/2, 9/16, 5/8 & 13/16" 1-Collet Chuck 1-Wrench	• 10PC SET INCLUDES 8-Collet 1/8, 1/4, 3/8, 1/2, 5/8, 3/4, 7/8 & 1" 1-Collet Chuck 1-Wrench
	• 17PC SET INCLUDES 15-Collet 1/8, 3/16, 1/4, 5/16, 3/8, 7/16, 1/2, 9/16, 5/8, 11/16, 3/4, 13/16, 7/8, 15/16 & 1" 1-Collet Chuck 1-Wrench

Item#	Chuck Shank	No.	Nut Style	Gage Length	Collet Set	Price (E)
3900-5300	#30	ER-32	Spanner	2.36"	14	163.87
3900-0505	#40	ER-32	Spanner	2.75"	14	151.98
3900-5301	#30	ER-40	Spanner	2.75"	17	261.96
3900-0538	#40	ER-40	Spanner	2.36"	10	157.11
3900-0540	#40	ER-40	Spanner	2.36"	17	208.68



Pro-Series NMTB 30 TAPER ER COLLET CHUCK SETS

- Made of high grade tool steel NMTB shank high precision collet chuck system.
- Hardened & ground body for extended tool life.
- With fitted case.
- Chuck T.I.R. to .0003".

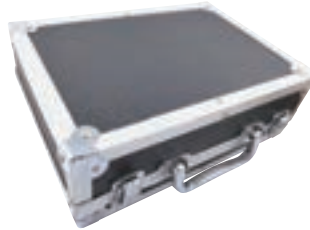
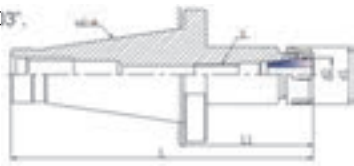

3900-4060 Shown

3900-4060	3900-4062
• 14PC SET INCLUDES 12-ER-32 Collet 1/16, 3/32, 1/8, 3/16, 1/4, 5/16, 3/8, 7/16, 1/2, 9/16, 5/8 & 13/16" 1-#30 Collet Chuck 1-Spanner Wrench	• 17PC SET INCLUDES 15-ER-40 Collet 1/8, 3/16, 1/4, 5/16, 3/8, 7/16, 1/2, 9/16, 5/8, 11/16, 3/4, 13/16, 7/8, 15/16 & 1" 1-#30 Collet Chuck 1-Spanner Wrench

Item#	Collet	NMTB Chuck Shank	Collet Set	Nut Style	Nut Dia. d1	Gage Length L1	L	Drawbar End	Price (E)
3900-4060	ER-32	#30	14	Spanner	2.0"	2.36"	2.36"	1/2"-13	233.91
3900-4062	ER-40	#30	17	Spanner	2.5"	2.75"	2.75"	1/2"-13	312.78

NMTB TAPER INTEGRAL PRECISION KEYLESS DRILL CHUCKS

- Integrated design maximizes rigidity & accuracy.
- Integral shank is more compact than a combined drill chuck and arbor and eliminates the chuck slipping on its arbor.
- Keyless, self tightening design.

Item#	Brand	Clamping Capacity	Shank	T.I.R.	Price (F)
3701-3001	HHIP	0~1/2"	#30	.0022"	201.22
3701-3011	HHIP	0~1/2"	#40	.0022"	217.20
3701-3015	HHIP	0~5/8"	#40	.0022"	233.16



HHIP PRO-SERIES

T.I.R. < .0022"



VERTEX
Max. T.I.R. < .002"

Item#	Brand	Clamping Capacity	Shank	T.I.R.	Price (F)
3701-3500	VERTEX	0~1/2"	#40	.0020"	231.87
3701-3625	VERTEX	1/8~5/8"	#40	.0020"	256.59

* Vertex Tightening Wrench Included

Z-AXIS SETTERS

PRECISION DIAL Z-AXIS SETTERS

- Efficient to set "0" point with built in dial indicator.
- Positioning accuracy and repeatability: 0.0004".
- Height: 2" or 4" (with mag base)
- Setter Dimension: 1.45" (square) x 2" (height).



4401-0050
\$104⁹⁷_(E)



With Mag Base
4401-0051
\$145⁷⁵_(E)

Pro-Series DIAL Z-AXIS SETTER

- Efficient to set "0" point with built in dial indicator.
- Positioning accuracy and repeatability: 0.0002".
- With magnetic base.
- Dimension: 2" (square) x 4" (height).



4401-0062
\$273²⁷_(E)

Pro-Series Z-Axis HEIGHT PRE-SETTER

- Base with magnet
- 50mm height
- Reading 0-50-0
- Accuracy: 0.01mm
- Weight: 2.6 lbs.
- Checking bar & case included.

MADE IN TAIWAN



4401-0054
\$284⁰⁵_(E)

Pro-Series OPTICAL HEIGHT PRE-SETTER

- Magnetic base
- 50mm height
- Red lamp illuminates when touched by ferrous material



4401-0052
\$263⁷⁸_(E)

MADE IN TAIWAN

Pro-Series DIAL Z-AXIS SETTERS

- Efficient to set "0" point with built in dial indicator.
- Positioning accuracy and repeatability: 0.0005".
- Dimension: 2" (square) x 2" (height).
- With fitted wooden case.



With Magnet
4401-0064
\$196³⁴_(E)



Without Magnet
4401-0063
\$179¹⁴_(E)

VERTEX BT TOOL HOLDER TIGHTENING FIXTURE STANDS

- Lightweight and compact design.
- Quick tool holder setting and locking.
- Securely hold BT tooling for pull stud installation and tool/collet change.

MADE IN TAIWAN



Item#	Shank Taper	D	d	3 Hole P.C.D.	H	(mm)						Wi. Lbs.	Price (F)
						A	B	C	D	E	F		
3900-4091	BT30	90	50	70	14(Dia.)x9x9(Dia.)	108	20	48	30	10	16	2.7	84.00
3900-4092	BT40	105	65	85	14(Dia.)x9x9(dia.)	130	20	50	50	10	16	4.9	84.00

HORIZONTAL/VERTICAL CNC TOOL HOLDER TIGHTENING FIXTURES

- 2 positions
- For mounting on worktable or cart.
- Quick and easy way to set tool holders horizontal or vertical



Item#	Tool Shank	Price (F)
3900-4080	BT30	155.63
3900-4081	BT40	155.63
3900-4083*	CAT30	67.20
3900-4084	CAT40	77.25
3900-4085	CAT50	162.02

*Limited Supply

Dasqua® WATERPROOF DIGITAL IP65 Z-AXIS SETTERS



0.001MM RESOLUTION

- Accuracy (tolerance range): $\pm 0.002\text{mm}/0.0001"$, Repeatability: $0.003\text{mm}/0.0001"$
- 3V Lithium battery CR2032



- Used to help tool setting
Can be used in IP65 working environment (with inductive measurement against splash water) and will not damage the tool edge

- Resolution reaches 0.001mm
Higher than other zero setting devices

- Lighting indicating at "0"
More obvious and accurate compared to mechanic zero setting device

- With magnetic base

Fixed on machine steadily and shorten tool setting time and improve work efficiency greatly

- Provided in fitted aluminum case

Item#	Height	Resolution	Price (F)
1801-1005	50mm	0.001mm/0.00005"	132.55
1801-1010	100mm	0.001mm/0.00005"	207.17

Dasqua® 1-2-3 BLOCKS

- Supplied with durable fitted ABS case.
- Product Dimensions: 1" x 2" x 3".
- Heat treated and case hardened to HRC 58-62.
- Hardened and precision ground on all 6 sides of each block.
- 23 holes consists of 5 tapped holes that are 3/8-16 for clamping and 18 untapped holes
- Sold in pairs.
- Tolerance of size $\pm 0.0002"$, Parallelism 0.0002", Height of pair 0.0002".
- Cross drilling design gives minimum weight and maximum strength.

**MATCHED PAIRS
AND SOLD AS PAIR**



Item#	Size	Squareness	Price (F)
8407-0005	1 x 2 x 3"	0.0001"/1"	45.40
8407-0010	1 x 2 x 3"	0.0003"/1"	30.24

RETENTION KNOBS

Style 1, RETENTION KNOBS-BT 40

- Heat treated alloy steel.
- All dimensions in accordance to ANSI specifications for CAT holders and MAS specifications for BT holders.



Item#	Machine Taper	Thru Coolant	Thread T.P.I.	Angle A.	Knob Dia. D1 (Inch/mm)	Neck Dia. D2 (Inch/mm)	Hole Dia. D3 (Inch/mm)	Pilot Dia. D4 (Inch/mm)	Dia. D (Inch/mm)	OAL L (Inch/mm)	Shoulder L1 (Inch/mm)	Shoulder L2 (Inch/mm)	Price(F)
3900-5392	BT40	YES	M16x2.0	45°	0.591/15	0.394/10	0.150/3.8	0.669/17	0.906/23	2.374/60.3	1.102/28	2.421/61.5	7.85
3900-5393	BT40	YES	M16x2.0	60°	0.591/15	0.394/10	0.150/3.8	0.669/17	0.906/23	2.374/60.3	1.102/28	2.421/61.5	10.38
3900-5503	BT40	N/A	M16x2.0	45°	0.591/15	0.394/10	N/A	0.669/17	0.906/23	2.374/60.3	1.102/28	2.421/61.5	10.52
3900-5504	BT40	N/A	M16x2.0	60°	0.591/15	0.394/10	N/A	0.669/17	0.906/23	2.374/60.3	1.102/28	2.421/61.5	10.52

Style 1, RETENTION KNOBS-BT 50

- SNCM 21 alloy steel hardened to HRC 52~56°
- All dimensions in accordance to ANSI specifications for CAT holders and MAS specifications for BT holders.



Item#	Machine Taper	Thru Coolant	Thread T.P.I.	Angle A.	Knob Dia. D1 (Inch/mm)	Neck Dia. D2 (Inch/mm)	Hole Dia. D3 (Inch/mm)	Pilot Dia. D4 (Inch/mm)	Dia. D (Inch/mm)	OAL L (Inch/mm)	Shoulder L1 (Inch/mm)	Shoulder L2 (Inch/mm)	Price(F)
3900-5397	BT50	YES	M24x3.0	45°	0.906/23	0.669/17	0.268/6.8	0.984/25	1.496/38	3.346/85	1.378/35	3.937/100	12.88
3900-5508	BT50	N/A	M24x3.0	45°	0.906/23	0.669/17	0.268/6.8	0.984/25	1.496/38	3.346/85	1.378/35	3.937/100	15.81

Style 1, RETENTION KNOBS-CAT 40

- Heat treated alloy steel hardened to HRC 52~56°.
- ANSI/AMSE B5.50-1994



*Limited Supply

Item#	Machine Taper	Thru Coolant	Thread T.P.I.	Angle A.	Knob Dia. D1 (Inch/mm)	Neck Dia. D2 (Inch/mm)	Hole Dia. D3 (Inch/mm)	Pilot Dia. D4 (Inch/mm)	Dia. D (Inch/mm)	OAL L (Inch/mm)	Shoulder L1 (Inch/mm)	Shoulder L2 (Inch/mm)	Price(F)
3900-5485	CAT40	N/A	M16x2.0	45°	0.591/15	0.394/10	N/A	0.669/17	0.906/23	2.244/57	0.984/25	2.362/60	16.82
3900-5486*	CAT40	N/A	M16x2.0	60°	0.591/15	0.394/10	N/A	N/A	0.906/23	2.244/57	0.984/25	2.362/60	11.75
3900-5491	CAT40	N/A	5/8~11	60°	0.591/15	0.394/10	N/A	N/A	0.906/23	2.244/57	0.984/25	2.362/60	11.97
3900-5528	CAT40	N/A	5/8~11	45°	0.591/15	0.394/10	N/A	N/A	0.906/23	2.244/57	0.984/25	2.362/60	14.85
3900-5529	CAT40	YES	5/8~11	45°	0.591/15	0.394/10	0.150/3.8	N/A	0.906/23	2.244/57	0.984/25	2.362/60	15.65
3900-5539	CAT40	YES	M16x2.0	45°	0.591/15	0.394/10	0.150/3.8	0.669/17	0.906/23	2.244/57	0.984/25	2.362/60	15.65

Style 1

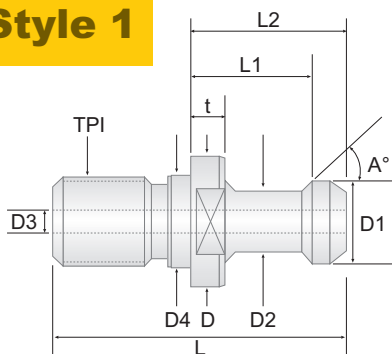

Style 2

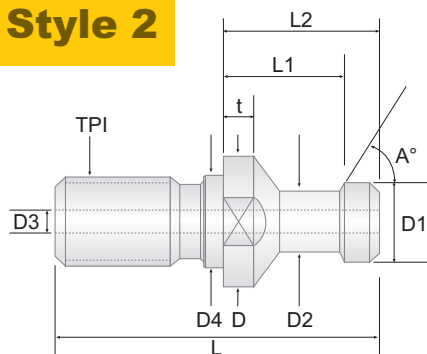

Style 3

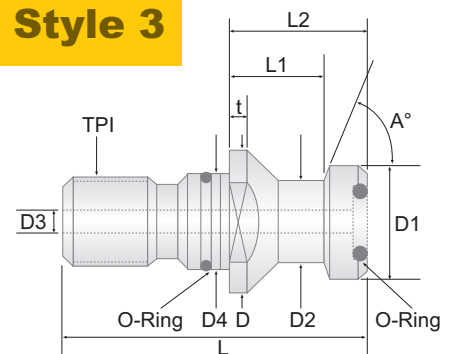

Retention Knob Safety!

Retention knobs are not intended to last forever. Your Safety Program must include Retention Knob Inspections. Knobs must be visually inspected for damage and checked for tightness every time the tool in the holder is changed. Every 2 or 3 years, depending on use, knobs should be removed from the holder and Magnetic Particle inspected. Any Retention Knobs showing indications of cracking must be discarded. If your machine is in a crash, or releases a tool prematurely, this is an indication that either the Retention Knob Fingers, Finger Guide, Belleville Washers in the Spindle, or the Retention Knob is damaged. The machine tool should not be used until inspected by Maintenance Personnel. In this case all the Retention Knobs in the machine should be checked for cracks or damage immediately.

Style 1, RETENTION KNOBS-CAT 50



- Heat treated alloy steel hardened to HRC 52~56°.
- ANSI/AMSE B5.50-1994

Item#	Machine Taper	Thru Coolant	Thread T.P.I.	Angle A.	Knob Dia. D1 (Inch/mm)	Neck Dia. D2 (Inch/mm)	Hole Dia. D3 (Inch/mm)	Pilot Dia. D4 (Inch/mm)	Dia. D (Inch/mm)	OAL L (Inch/mm)	Shoulder L1 (Inch/mm)	Shoulder L2 (Inch/mm)	Price(F)
3900-5493	CAT50	N/A	1~8	60°	0.906/23	0.669/17	N/A	N/A	1.496/38	3.094/78.6	1.386/35.2	3.937/100	26.18
3900-5535	CAT50	N/A	1~8	45°	0.906/23	0.669/17	N/A	N/A	1.496/38	3.094/78.6	1.386/35.2	3.937/100	23.55

Style 2, RETENTION KNOBS-ISO 40A



- Heat treated alloy steel.
- All dimensions in accordance to ISO/DIS7388/2-1984A specifications.

Item#	Machine Taper	Thru Coolant	Thread T.P.I.	Angle A.	Knob Dia. D1 (Inch/mm)	Neck Dia. D2 (Inch/mm)	Hole Dia. D3 (Inch/mm)	Pilot Dia. D4 (Inch/mm)	Dia. D (Inch/mm)	OAL L (Inch/mm)	Shoulder L1 (Inch/mm)	Shoulder L2 (Inch/mm)	Price(F)
3900-5376	ISO40A	N/A	M16x2.0	15°	0.748/19	0.551/14	N/A	0.669/17	0.906/23	2.126/54	0.787/20	1.575/40	8.25
3900-5381	ISO40A	YES	M16x2.0	15°	0.748/19	0.551/14	0.276/7	0.669/17	0.906/23	2.126/54	0.787/20	1.575/40	15.30

Style 2, RETENTION KNOBS-CAT 50



- Heat treated alloy steel hardened to HRC 52~56°.
- ANSI/AMSE B5.50-1994

Item#	Machine Taper	Thru Coolant	Thread T.P.I.	Angle A.	Knob Dia. D1 (Inch/mm)	Neck Dia. D2 (Inch/mm)	Hole Dia. D3 (Inch/mm)	Pilot Dia. D4 (Inch/mm)	Dia. D (Inch/mm)	OAL L (Inch/mm)	Shoulder L1 (Inch/mm)	Shoulder L2 (Inch/mm)	Price(F)
3900-5378	CAT50	YES	M24x3.0	15°	1.102/28	0.827/21	0.451/11.45	0.984/25	1.417/36	2.913/74	0.984/25	1.575/40	16.80

Style 3, RETENTION KNOBS-ISO 50A



- Heat treated alloy steel.
- All dimensions in accordance to ISO/DIS7388/2-1984A specifications.

Item#	Machine Taper	Thru Coolant	Thread T.P.I.	Angle A.	Knob Dia. D1 (Inch/mm)	Neck Dia. D2 (Inch/mm)	Hole Dia. D3 (Inch/mm)	Pilot Dia. D4 (Inch/mm)	Dia. D (Inch/mm)	OAL L (Inch/mm)	Shoulder L1 (Inch/mm)	Shoulder L2 (Inch/mm)	Price(F)
3900-5373	ISO50A	YES	M24x3.0	45°	1.102/28	0.827/21	0.451/11.45	0.984/25	1.417/36	2.913/74	0.984/25	1.575/40	18.00

Style 3, RETENTION KNOBS-CAT 50



- Heat treated alloy steel hardened to HRC 52~56°.
- ANSI/AMSE B5.50-1994

Item#	Machine Taper	Thru Coolant	Thread T.P.I.	Angle A.	Knob Dia. D1 (Inch/mm)	Neck Dia. D2 (Inch/mm)	Hole Dia. D3 (Inch/mm)	Pilot Dia. D4 (Inch/mm)	Dia. D (Inch/mm)	OAL L (Inch/mm)	Shoulder L1 (Inch/mm)	Shoulder L2 (Inch/mm)	Price(F)
3900-5383	CAT50	N/A	M24x3.0	15°	1.142/29	0.768/19.5	0.445/11.3	0.984/25	1.417/36	2.567/65.2	0.692/17.58	1.811/46	16.80

Style 1

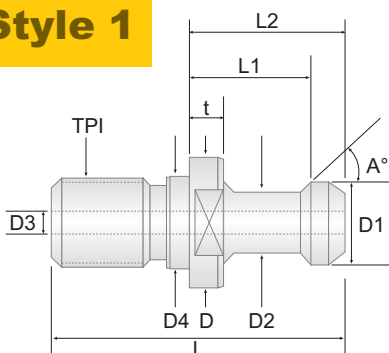

Style 2

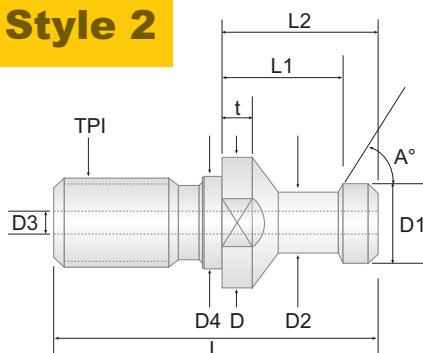

Style 3

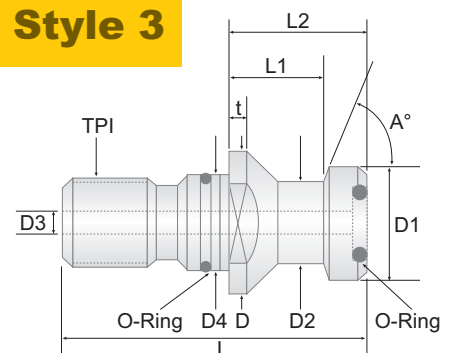

RETENTION KNOBS

Style 4, RETENTION KNOBS-ISO 40B

- Heat treated alloy steel.
- All dimensions in accordance to ISO/DIS7388/2-1984A specifications.



Item#	Machine Taper	Thru Coolant	Thread T.P.I.	Angle A.	Knob Dia. D1 (Inch/mm)	Neck Dia. D2 (Inch/mm)	Hole Dia. D3 (Inch/mm)	Pilot Dia. D4 (Inch/mm)	Dia. D (Inch/mm)	OAL L (Inch/mm)	Shoulder L1 (Inch/mm)	Shoulder L2 (Inch/mm)	Price(F)
3900-5372	ISO40B	YES	M16x2.0	45°	0.748/19	0.512/13	0.276/7	0.669/17	0.906/23	1.752/44.5	0.433/11	1.181/30	13.86

Style 4, RETENTION KNOBS-BT 40

- Heat treated alloy steel.
- All dimensions in accordance to ANSI specifications for CAT holders and MAS specifications for BT holders.



Item#	Machine Taper	Thru Coolant	Thread T.P.I.	Angle A.	Knob Dia. D1 (Inch/mm)	Neck Dia. D2 (Inch/mm)	Hole Dia. D3 (Inch/mm)	Pilot Dia. D4 (Inch/mm)	Dia. D (Inch/mm)	OAL L (Inch/mm)	Shoulder L1 (Inch/mm)	Shoulder L2 (Inch/mm)	Price(F)
3900-5497	BT40	YES	M16x2.0	45°	0.740/18.8	0.490/12.45	0.315/8	0.669/17	0.866/22	1.736/44.1	0.551/14	1.22/31	13.86

Style 4, RETENTION KNOBS-BT 50

- Heat treated alloy steel hardened to HRC 52-56°.
- All dimensions in accordance to ANSI specifications for CAT holders and MAS specifications for BT holders.



Item#	Machine Taper	Thru Coolant	Thread T.P.I.	Angle A.	Knob Dia. D1 (Inch/mm)	Neck Dia. D2 (Inch/mm)	Hole Dia. D3 (Inch/mm)	Pilot Dia. D4 (Inch/mm)	Dia. D (Inch/mm)	OAL L (Inch/mm)	Shoulder L1 (Inch/mm)	Shoulder L2 (Inch/mm)	Price(F)
3900-5499	BT50	YES	M24x3.0	45°	1.140/28.95	0.820/20.83	0.394/10	0.984/25	1.457/37	2.567/65.2	0.692/17.58	1.969/50	19.62

Style 4, RETENTION KNOBS-ISO 50B

- Heat treated alloy steel.
- All dimensions in accordance to ISO/DIS7388/2-1984A specifications.

Limited Supply!



Item#	Machine Taper	Thru Coolant	Thread T.P.I.	Angle A.	Knob Dia. D1 (Inch/mm)	Neck Dia. D2 (Inch/mm)	Hole Dia. D3 (Inch/mm)	Pilot Dia. D4 (Inch/mm)	Dia. D (Inch/mm)	OAL L (Inch/mm)	Shoulder L1 (Inch/mm)	Shoulder L2 (Inch/mm)	Price(F)
3900-5374	ISO50B	YES	M24x3.0	45°	1.142/29	0.768/19.5	0.445/11.3	0.984/25	1.417/36	2.583/65.6	0.692/17.58	1.969/50	13.71

Style 4

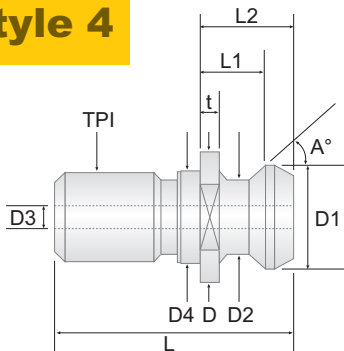

Style 5

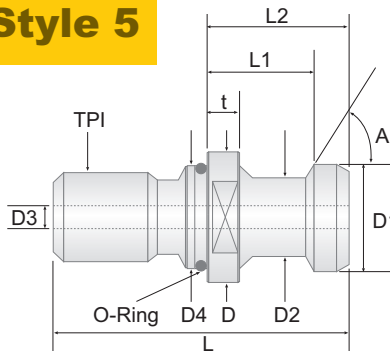

Retention Knob Safety!

Retention knobs are not intended to last forever. Your Safety Program must include Retention Knob Inspections. Knobs must be visually inspected for damage and checked for tightness every time the tool in the holder is changed. Every 2 or 3 years, depending on use, knobs should be removed from the holder and Magnetic Particle inspected. Any Retention Knobs showing indications of cracking must be discarded. If your machine is in a crash, or releases a tool prematurely, this is an indication that either the Retention Knob Fingers, Finger Guide, Belleville Washers in the Spindle, or the Retention Knob is damaged. The machine tool should not be used until inspected by Maintenance Personnel. In this case all the Retention Knobs in the machine should be checked for cracks or damage immediately.

Style 4, RETENTION KNOBS-CAT 40



- Heat treated alloy steel hardened to HRC 52~56°.
- ANSI/AMSE B5.50-1994

Item#	Machine Taper	Thru Coolant	Thread T.P.I.	Angle A.	Knob Dia. D1 (Inch/mm)	Neck Dia. D2 (Inch/mm)	Hole Dia. D3 (Inch/mm)	Pilot Dia. D4 (Inch/mm)	Dia. D (Inch/mm)	OAL L (Inch/mm)	Shoulder L1 (Inch/mm)	Shoulder L2 (Inch/mm)	Price(F)
3900-5512	CAT40	N/A	5/8-11	45°	0.740/18.79	0.488/12.4	N/A	N/A	0.886/22.5	1.535/39	0.433/11	1.26/32	14.64
3900-5513	CAT40	N/A	M16x2.0	45°	0.590/18.79	0.486/12.34	N/A	N/A	0.886/22.5	1.535/39	0.433/11	1.26/32	14.90
3900-5520	CAT40	YES	5/8-11	45°	0.740/18.79	0.400/12.34	0.276/7	N/A	0.886/22.5	1.496/38	0.433/11	1.24/31.5	12.32
3900-5521	CAT40	YES	M16x2.0	45°	0.740/18.79	0.486/12.34	0.276/7	N/A	0.937/23.8	1.496/38	0.433/11	1.24/31.5	15.65

Style 4, RETENTION KNOBS-CAT 50



- Heat treated alloy steel hardened to HRC 52~56°.
- ANSI/AMSE B5.50-1994

Item#	Machine Taper	Thru Coolant	Thread T.P.I.	Angle A.	Knob Dia. D1 (Inch/mm)	Neck Dia. D2 (Inch/mm)	Hole Dia. D3 (Inch/mm)	Pilot Dia. D4 (Inch/mm)	Dia. D (Inch/mm)	OAL L (Inch/mm)	Shoulder L1 (Inch/mm)	Shoulder L2 (Inch/mm)	Price(F)
3900-5492	CAT50	N/A	1~8	45°	1.140/28.95	0.820/20.83	N/A	N/A	1.417/36	2.307/58.6	0.692/17.58	1.969/50	13.20
3900-5519	CAT50	N/A	M24X3.0	45°	1.140/28.95	0.820/20.83	N/A	N/A	1.437/36.5	2.307/58.6	0.692/17.58	1.969/50	23.55
3900-5522	CAT50	YES	1~8	45°	1.140/28.95	0.820/20.83	0.451/11.45	N/A	1.43736.5	2.307/58.6	0.692/17.58	1.969/50	19.62
3900-5524	CAT50	YES	M24x3.0	45°	1.140/28.95	0.820/20.83	0.451/11.45	N/A	1.43736.5	2.307/58.6	0.692/17.58	1.969/50	18.50

Style 5, RETENTION KNOBS-ISO 40A



- Heat treated alloy steel.
- All dimensions in accordance to ISO/DIS7388/2-1984A specifications.

Item#	Machine Taper	Thru Coolant	Thread T.P.I.	Angle A.	Knob Dia. D1 (Inch/mm)	Neck Dia. D2 (Inch/mm)	Hole Dia. D3 (Inch/mm)	Pilot Dia. D4 (Inch/mm)	Dia. D (Inch/mm)	OAL L (Inch/mm)	Shoulder L1 (Inch/mm)	Shoulder L2 (Inch/mm)	Price(F)
3900-5371	ISO40A	YES	M16x2.0	45°	0.748/19	0.551/14	0.276/7	0.669/17	0.906/23	1.752/44.5	0.433/11	1.181/30	14.28

Style 5, RETENTION KNOBS-BT 50



- SNCM 21 alloy steel hardened to HRC 52~56°
- All dimensions in accordance to ANSI specifications for CAT holders and MAS specifications for BT holders.

Item#	Machine Taper	Thru Coolant	Thread T.P.I.	Angle A.	Knob Dia. D1 (Inch/mm)	Neck Dia. D2 (Inch/mm)	Hole Dia. D3 (Inch/mm)	Pilot Dia. D4 (Inch/mm)	Dia. D (Inch/mm)	OAL L (Inch/mm)	Shoulder L1 (Inch/mm)	Shoulder L2 (Inch/mm)	Price(F)
3900-5398	BT50	YES	M24x3.0	60°	0.906/23	0.669/17	0.236/6	0.984/25	1.496/38	3.346/85	1.378/35	3.937/100	18.90

Style 4

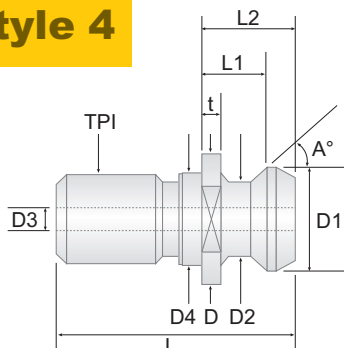

Style 5

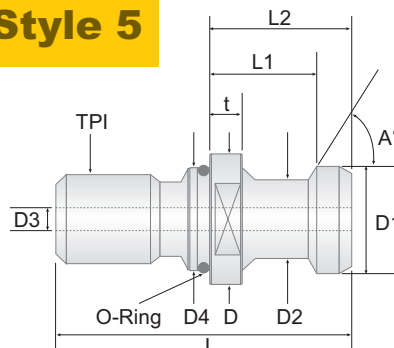

Retention Knob Safety!

Retention knobs are not intended to last forever. Your Safety Program must include Retention Knob Inspections. Knobs must be visually inspected for damage and checked for tightness every time the tool in the holder is changed. Every 2 or 3 years, depending on use, knobs should be removed from the holder and Magnetic Particle inspected. Any Retention Knobs showing indications of cracking must be discarded. If your machine is in a crash, or releases a tool prematurely, this is an indication that either the Retention Knob Fingers, Finger Guide, Belleville Washers in the Spindle, or the Retention Knob is damaged. The machine tool should not be used until inspected by Maintenance Personnel. In this case all the Retention Knobs in the machine should be checked for cracks or damage immediately.

CAT40 TOOL HOLDERS

CAT 40 "V" FLANGE END MILL HOLDERS

INCH

RETENTION KNOB THREAD: 5/8" -11

Item#	Bore Dia. d	Gage Depth L	Nose Dia. D	Price (F)	Item#	Bore Dia. d	Gage Depth L	Nose Dia. D	Price (F)
3900-4101*	3/16	1.38	0.68	35.29	3900-4111	1/2	2.50	1.25	68.12
3900-4102*	3/16	2.50	0.68	40.83	3900-4112*	1/2	4.72	1.38	42.86
3900-4103	1/4	1.38	0.88	65.69	3900-4113*	5/8	1.75	1.75	47.78
3900-4104*	1/4	2.50	0.88	40.83	3900-4114	5/8	2.50	1.50	76.88
3900-4105	5/16	1.38	1	65.69	3900-4115	5/8	3.94	1.62	74.30
3900-4106	5/16	2.50	1	65.69	3900-4116	3/4	1.75	1.75	76.88
3900-4107	3/8	1.38	1	65.69	3900-4117	3/4	2.50	1.75	76.88
3900-4108	3/8	2.50	1	62.57	3900-4118	3/4	3.94	1.75	76.88
3900-4191*	7/16	1.38	1.25	68.12	3900-4120	7/8	3.94	2	76.88
3900-4109	7/16	2.50	1.25	68.12	3900-4125*	1-1/4	3.94	2.62	82.50
3900-4110	1/2	1.75	1.75	68.12					

*Limited Supply

- For CNC machines having CAT 40 taper spindles
- "V" flange end mill adapter
- Hardened and precision ground

T.I.R. < .0002"

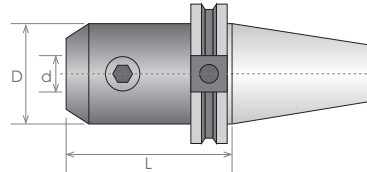

Pro-Series CAT 40 HIGH SPEED, BALANCED END MILL HOLDERS

- Made of high grade alloy steel
- Balanced to 15,000 RPM
- Tolerance: .0003" Max.

T.I.R. < 0.01mm

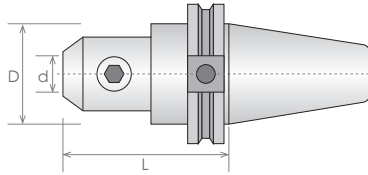

SUPERIOR FINISH & CRAFTSMANSHIP

Item#	Bore Dia. d	Gage Length L	Nose Dia. D	Price (F)
3900-7721	3/16	2.5"	0.69"	65.49
3900-7724	1/4	3.0"	0.78"	62.37
3900-7727	5/16	3.0"	0.88"	62.37
3900-7730	3/8	3.0"	1"	63.62
3900-7736	1/2	3.0"	1.25"	64.47
3900-7740	5/8	3.0"	1.5"	63.62
3900-7745	3/4	3.0"	1.75"	63.62
3900-7749	7/8	3.5"	1.88"	69.97
3900-7751	1	4.0"	2"	69.97
3900-7756	1-1/4	4.6"	2.5"	69.97
3900-7760	1-1/2	4.5"	2.5"	76.34

Pro-Series ULTRA PRECISION KEYLESS DRILL CHUCKS W/ INTEGRAL CAT 40 SHANKS

- Integrated design maximizes rigidity & accuracy.
- Integral shank is more compact than a combined drill chuck and arbor and eliminates the chuck slipping on its arbor.
- Keyless, self tightening design.
- **Tightening wrench included.**

Max. T.I.R. < .002"



Item#	Clamping Capacity	Shank	Price (F)
3701-0500	1/64~1/2"	CAT-40	240.15
3701-0625	1/8~5/8"	CAT-40	256.59



MADE IN TAIWAN

HORIZONTAL/VERTICAL CNC TOOL HOLDER TIGHTENING FIXTURES

- 2 positions
- For mounting on worktable or cart.
- Quick and easy way to set tool holders horizontal or vertical

Item#	Tool Shank	Price (F)
3900-4080	BT30	155.63
3900-4081	BT40	155.63
3900-4083*	CAT30	67.20
3900-4084	CAT40	77.25
3900-4085	CAT50	162.02

*Limited Supply



CAT40 TOOL HOLDERS

CAT 40 "V" FLANGE DRILL CHUCK ARBORS

- For CNC machines having CAT 40 taper spindles
- Hardened and precision ground
- Gage depth: 1.772"

RETENTION KNOB THREAD: 5/8" -11

Item#	CAT Taper#	Jacobs No.	Price (F)
3900-4205	40	JT33	68.12
3900-4207	40	JT6	70.12
3900-4208	40	JT4	70.12
3900-4209	40	JT3	70.12
3900-4206	40	JT2	70.12



CAT 40 "V" FLANGE MORSE TAPER ADAPTERS

- For CNC machines having CAT 40 taper spindles
- Hardened and precision ground

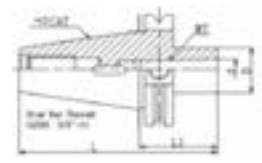

RETENTION KNOB THREAD: 5/8" ~11

Item#	CAT Taper#	Morse Taper No.	Gage Depth L1	D	OAL L	Price (F)
3900-4305	40	MT2	2.375"	1.26"	5.2"	61.28
3900-4307	40	MT3	3.000"	1.57"	5.6"	76.22
3900-4309	40	MT4	2.562"	1.89"	6.6"	77.85



CAT 40 "V" FLANGE SHELL END MILL HOLDERS

- CAT 40 Shell End Mill Holder.
- For CNC machines having CAT 40 taper spindles.
- Hardened and precision ground.

RETENTION KNOB THREAD: 5/8" -11

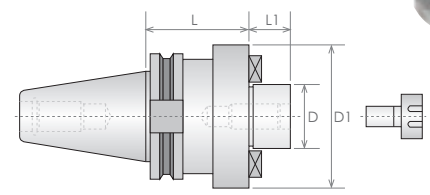

Item#	Dia. for Bore in Shell End Mill D	D1	Gage Length L	L1	Bore Thread	Price (F)
3900-4255	3/4"	1.5"	1.50"	0.69"	3/8"~24	82.34
3900-4257	1"	2.0"	2.00"	0.69"	1/2"~20	78.93
3901-4257	1"	2.19"	2.06"	0.69"	1/2"~20	81.82
3900-4259	1-1/4"	2.5"	2.19"	0.69"	5/8"~18	78.93
3901-4259	1-1/4"	2.75"	2.21"	0.69"	5/8"~18	113.44
3900-4261	1-1/2"	3.0"	2.21"	0.94"	3/4"~16	87.58
3901-4261	1-1/2"	3.81"	2.21"	0.94"	3/4"~16	95.15

PRECISION BORING SHANKS

- Use for boring heads.
- Made of high grade tool steel.
- Hardened and ground.



1-1/2" ~ 18 MOUNTING THREAD

Item#	Taper of Shank	Draw Bar End	Price (F)
1001-0440	CAT40	5/8"~11	54.50

SHELL END MILL HOLDER SCREWS

- Replacement screw for shell end mill holders.



Bore	Thread	D (mm)	L (mm)	Item#	Price (F)
1/2"	1/4"~28	16.7	21	3900-0761	4.67
3/4"	3/8"~24	22.2	27	3900-0764	4.67
1"	1/2"~20	30.2	33	3900-0767	8.00
1-1/4"	5/8"~18	38.1	39	3900-0770	7.92
1-1/2"	3/4"~16	47.6	45	3900-0773	9.60
2"	1"~14	63.1	52	3900-0777	9.99

CAT 40 SK LYNDEX STYLE SLIM COLLET CHUCKS

- Dual contacts of taper and flange.
- Increase spindle contact by 53% over standard holders.
- Prevent tools from pulling into spindle.
- Balanced to 20,000 RPM.



RUNOUT ≤ 5 MICRON

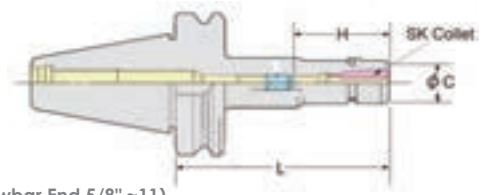

CAT-40 (Drawbar End 5/8" ~11)

Item#	Collet Series	Collet Range	H	C	Gage Depth L (mm)	Price (F)
3901-5504	SK10	0.069~0.393"	1.181~1.969"	1.083"	90	131.38
3901-5506	SK10	0.069~0.393"	1.181~1.969"	1.083"	120	148.50
3901-5523	SK16	0.108~0.630"	1.772~2.756"	1.575"	90	131.38
3901-5525	SK16	0.108~0.630"	1.772~2.756"	1.575"	120	148.50

Collets shown on page 238

CAT 40 ER HOLDERS

CAT 40 ER COLLET CHUCKS

- For CNC machines having CAT 40 taper spindles.
- Hardened and precision ground.

CAT-40 (DRAWBAR END: 5/8" ~11)

T.I.R. ≤ 0.005mm

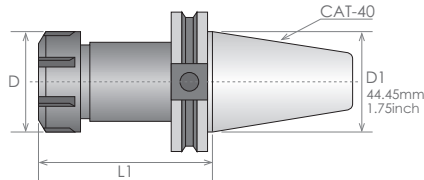

Item#	Type	Collet Range	Nut Style	Nut Dia. D	Gage Depth L1	Price (F)
3900-4362	ER-16	0.019~0.406"	Hex	1.1"	2.50"	64.87
3900-4361	ER-16	0.019~0.406"	Hex	1.1"	3.50"	64.87
3900-2060*	ER-16	0.019~0.406"	Hex	1.1"	2.76"	90.75
3900-2061*	ER-16	0.019~0.406"	Hex	1.1"	4.00"	87.80
3900-2028	ER-20	0.040~0.511"	Hex	1.4"	2.75"	68.52
3900-2039*	ER-20	0.040~0.511"	Hex	1.4"	4.00"	45.36
3900-2528	ER-25	0.040~0.629"	Spanner	1.7"	2.75"	57.74
3900-2539*	ER-25	0.040~0.629"	Spanner	1.7"	4.00"	58.98
3900-2073*	ER-32	0.078~0.787"	Spanner	2.0"	2.76"	87.80
3900-4369	ER-32	0.078~0.787"	Spanner	2.0"	3.20"	67.74
3900-4364*	ER-32	0.078~0.787"	Spanner	2.0"	4.00"	53.83
3900-4028	ER-40	0.120~1.020"	Spanner	2.5"	2.75"	72.18
3900-4039*	ER-40	0.120~1.020"	Spanner	2.5"	4.00"	49.30

*Limited Supply

CAT 40 ER SPRING COLLET CHUCK SETS

- High precision collet chuck system suitable for all milling and drilling applications.
- Unique self-releasing system.
- Wide holding range.
- With fitted case.
- Accuracy to .0005".

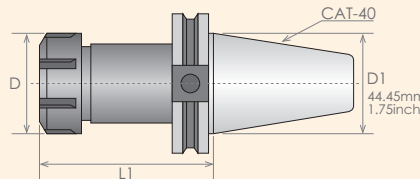

ER-16	ER-25	ER-32	ER-40
• 11PC SET INCLUDES 9-Collet 1/16, 3/32, 1/8, 3/16, 7/32, 1/4, 5/16, 11/32 & 3/8" 1-Collet Chuck 1-Wrench	• 17PC SET INCLUDES 15-Collet 1/16, 3/32, 1/8, 3/16, 7/32, 1/4, 5/16, 11/32, 3/8, 13/32, 7/16, 1/2, 17/32, 9/16 & 5/8" 1-Collet Chuck 1-Wrench	• 20PC SET INCLUDES 18-Collet 3/32, 1/8, 3/16, 7/32, 1/4, 5/16, 11/32, 3/8, 13/32, 7/16, 1/2, 17/32, 9/16, 5/8, 21/32, 11/16, 23/32 & 3/4" 1-Collet Chuck 1-Wrench	• 25PC SET INCLUDES 23-Collet 1/8, 3/16, 7/32, 1/4, 5/16, 11/32, 3/8, 13/32, 7/16, 1/2, 17/32, 9/16, 5/8, 21/32, 11/16, 3/4, 25/32, 13/16, 27/32, 7/8, 15/16, 31/32 & 1" 1-Collet Chuck 1-Wrench

Item#	Type	Nut Style	Collet Set	Nut Dia. D	Gage Length L1	Price (E)
3900-4014	ER-16	Hex	11	1.1"	2.75"	168.45
3900-4023	ER-25	Spanner	17	1.7"	2.75"	185.61
3900-4029	ER-32	Spanner	20	2.0"	3.20"	219.45
3900-4042	ER-40	Spanner	25	2.5"	2.75"	274.31

Pro-Series CAT 40 ER SPRING COLLET CHUCK SETS

- High precision collet chuck system suitable for all milling and drilling applications.
- Unique self-releasing system.
- Wide holding range.
- With fitted metal case.
- Accuracy to .0005".

Max. T.I.R. ≤ 0.0005"



ER-16	ER-25	ER-32	ER-40
• 11PC SET INCLUDES 9-Collet 1/16, 3/32, 1/8, 3/16, 7/32, 1/4, 5/16, 11/32 & 3/8" 1-Collet Chuck 1-Wrench	• 12PC SET INCLUDES 10-Collet 3/32, 1/8, 3/16, 1/4, 5/16, 3/8, 7/16, 1/2, 9/16 & 5/8" 1-Collet Chuck 1-Wrench	• 20PC SET INCLUDES 18-Collet 3/32, 1/8, 3/16, 7/32, 1/4, 5/16, 11/32, 3/8, 13/32, 7/16, 1/2, 17/32, 9/16, 5/8, 21/32, 11/16, 23/32 & 3/4" 1-Collet Chuck 1-Wrench	• 25PC SET INCLUDES 23-Collet 1/8, 3/16, 7/32, 1/4, 5/16, 11/32, 3/8, 13/32, 7/16, 1/2, 17/32, 9/16, 5/8, 21/32, 11/16, 3/4, 25/32, 13/16, 27/32, 7/8, 15/16, 31/32 & 1" 1-Collet Chuck 1-Wrench

Item#	Type	Collet Set	Size Range	Nut Style	Gage Length	Price (E)
3900-4016	ER-16	11	1/16~3/8"	Hex	2.50"	304.78
3900-4025	ER-25	12	3/32~5/8"	Spanner	2.75"	421.57
3900-4032	ER-32	20	3/32~3/4"	Spanner	3.20"	451.11
3900-4040	ER-40	25	1/8~1"	Spanner	2.75"	555.25

Pro-Series 3.98" SELF CENTERING CNC VISE

- Reversible Jaw: remove 4 screws to re-install jaws.
- Suitable for 4/5 axis CNC machines
- Repeat clamping tolerance +/- 0.0004"/ 0.01mm
- Material: FCD 60, high tension cast iron slide way has hardness of HRC 45.
- Interchangeable jaw heat treated to HRC 50.
- Lock down design to keep work piece from lifting.



MADE IN TAIWAN

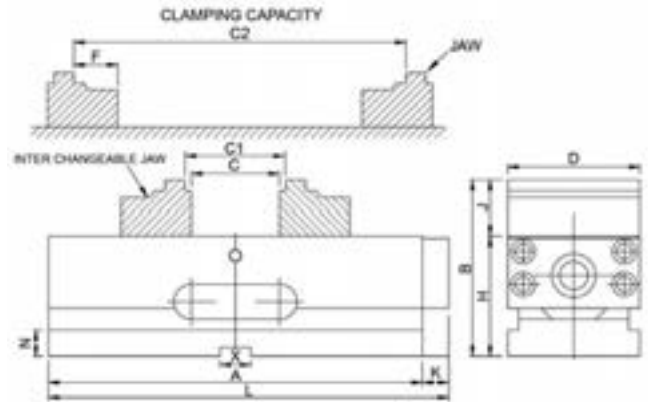

SELF-CENTERING

3900-2216
\$1,384⁴⁵_(F)

Jaw Width D	Jaw Depth J	Jaw Open C	Vise Height B	OAL L	Wt.	Max. Clamping C1	Clamping Range For C2	Max. Clamping Force	Torque For Clamping	A	F	H	K	N	X
3.98"	1.57"	5.20"	4.72"	10.24"	41 lbs	5.51"	2.44~7.56"	400 kgf	2.6m/kgf	9.45"	1.18"	3.15"	0.63"	0.83"	0.79"

Pro-Series 2.36" SELF CENTERING CNC VISE WITH SWIVEL BASE

- Suitable for 4/5 axis CNC machines
- Repeat clamping tolerance +/- 0.0004"/0.01mm
- Material: FCD 60, high tension cast iron slide way has hardness of HRC 450
- Interchangeable jaw heat treatment to HRC 55°.
- Lock down force to keep work piece from lifting.
- Swivel base 8" diameter x 22mm thickness
- Clamping Capacity: 1.77~5.51"

MADE IN TAIWAN

SWIVEL BASE INCLUDED



Item#	Jaw Width	Jaw Depth	Jaw Opening	Vise Height	OAL	Price (F)
3900-2220	2.36"	0.95"	3.94"	3.15 (w/o base)	7.3"	1,652.12

VERTEX BT TOOL HOLDER TIGHTENING FIXTURE STANDS

- Lightweight and compact design.
- Securely hold BT tooling for pull stud installation and tool/collet change.
- Quick tool holder setting and locking.



MADE IN TAIWAN

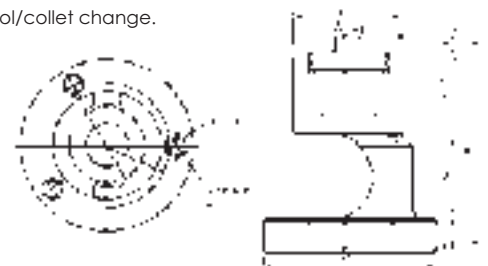

Item#	Shank Taper	D	d	3 Hole P.C.D.	H	(mm)						Wt. Lbs.	Price (F)
						A	B	C	D	E	F		
3900-4091	BT30	90	50	70	14(Dia.)x9x9(Dia.)	108	20	48	30	10	16	2.7	84.00
3900-4092	BT40	105	65	85	14(Dia.)x9x9(dia.)	130	20	50	50	10	16	4.9	84.00

BT30 & 40 TOOL HOLDERS

BT 30 & 40 TO JT DRILL CHUCK ARBORS

- For CNC machines having BT taper spindles.
- Concentricity .0002".
- All critical surfaces are hardened and precision ground.

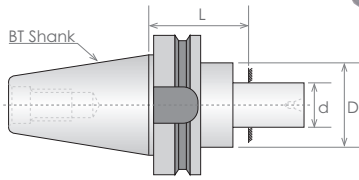

*Limited Supply

Item#	BT Taper	JT Taper	Gage Depth L (Inch)	D (Inch)	OAL (Inch)	Price (F)
3900-4194	30	2	1.77	1.18	4.6	54.06
3900-4195	30	3	1.77	1.38	4.9	53.54
3900-4196	30	4	1.77	1.58	5.3	53.54
3900-4198*	30	33	1.77	1.18	3.7	37.44
3900-4199	40	2	1.77	1.18	5.2	59.72
3900-4200	40	3	1.77	1.38	5.6	59.72
3900-4201	40	4	1.77	1.58	6.0	59.72
3900-4202	40	6	1.77	1.18	5.4	59.72
3900-4203	40	33	1.77	1.18	5.4	59.72

BT 30 & 40 TO MORSE TAPER ADAPTORS

- For CNC machines having BT taper spindles.
- All critical surfaces are hardened and precision ground.
- Concentricity .0002".

Item#	BT Taper	MT Taper	Gage Depth L1 (Inch)	D (Inch)	L (Inch)	Price (F)
3900-8701	30	MT2	2.36	1.26	4.3	55.68
3900-8702	30	MT3	3.15	1.58	5.0	55.00
3900-8705	40	MT2	1.97	1.26	4.5	57.64
3900-8708	40	MT3	2.76	1.58	5.3	66.88
3900-8710	40	MT4	3.54	1.89	6.1	65.34

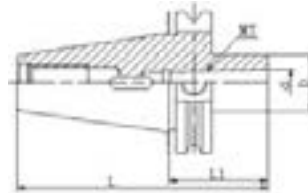

BT30 & 40 SHANK INTEGRAL ULTRA PRECISION KEYLESS DRILL CHUCKS

- Integrated design maximizes rigidity & accuracy.
- Integral shank is more compact than a combined drill chuck and arbor and eliminates the chuck slipping on its arbor.
- Keyless, self tightening design.

Item#	Brand	Clamping Capacity	Shank	Origin	Price (F)
3701-1050	VERTEX	1/64~1/2"	BT30	TAIWAN	240.15
3701-1054	VERTEX	1/64~1/2"	BT40	TAIWAN	207.45
3701-1062	VERTEX	1/8~5/8"	BT40	TAIWAN	238.78
3701-3503*	HHIP	1/64~1/2"	BT40	CHINA	172.44
3701-3628*	HHIP	1/64~5/8"	BT40	CHINA	181.50

* Limited Supply



Max. T.I.R. < 0.002"

Pro-Series BT40 HI-TORQUE INTEGRATED KEYLESS DRILL CHUCKS

- Reinforce torque design to increase more clamping power.
- Integrated design maximizes rigidity & accuracy
- Right turn and left turn allowable.
- Maximum T.I.R. does not exceed .002".
- Max. speed 6000 RPM.
- Supplied with wrench.

Limited Supply!

BT40 TAPER

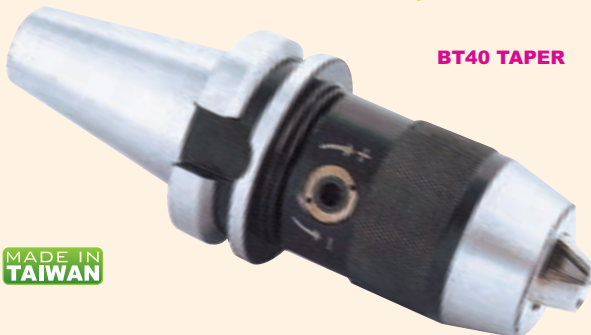

MADE IN TAIWAN

Item#	Clamping Range	Price (F)
3701-2650	.02~1/2"	238.85
3701-2662	.12~5/8"	249.70

BT40 ULTRA PRECISION INTEGRAL DRILL CHUCKS - HEX-KEY LOCKING

- Manufactured and tested at a world class factory that produces highest quality European brands (Babel).
- Suitable for CNC and high precision machine applications.
- High precision and concentricity.
- Right and left rotation.
- High gripping force with effortless tool clamping.
- Short and sturdy design: tool shank and chuck form one unit.
- Simple operation: Quick tool change inside or outside of machine, no unintentional opening in case of sudden spindle stop or change of direction.
- Tightening wrench included.
- Runout test of drill chucks is done with a torque of approx 12 Nm using the following test mandrels:
1/2": 6 mm, 8 mm, 12 mm
5/8": 6 mm, 8 mm, 12 mm und 16 mm

T.I.R. < 0.0012"



BT40 Shank

Item#	Capacity	A	D	Price (F)
3701-4650	1/2"	3.50"	1.77"	551.57
3701-4652	5/8"	3.74"	1.97"	612.87



BT40 SHELL END MILL HOLDERS

- For CNC machines having BT taper spindles.
- Concentricity .0002".
- All critical surfaces are hardened and precision ground.

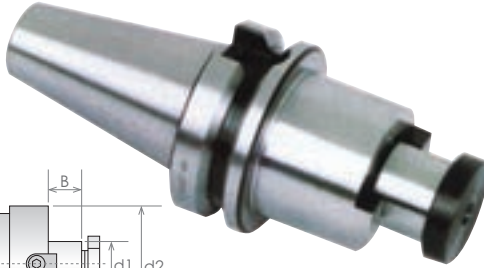
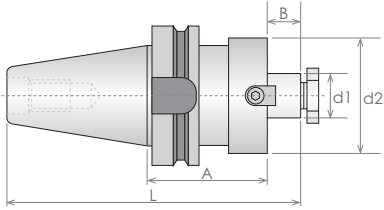

*Limited Supply

BT40 (INCH BORE DIAMETER)

Item#	Bore Dia. d1 (Inch)	Gage Depth A (mm)	d2 (mm)	Arbor Thread	Price (F)
3900-4237*	7/8	60	40	M16	50.00
3900-4238*	1	60	48	M16	54.96
3900-4239*	1-1/4	60	58	M16	56.25
3900-4240*	1-1/2	60	70	M16	85.80

BT40 (METRIC BORE DIAMETER)

Item#	Bore Dia. d1 (mm)	Gage Depth A (mm)	d2 (mm)	Arbor Thread	Price (F)
3900-4241	22	45	40	M16	72.23
3900-4245	27	60	48	M16	73.52
3900-4250	32	60	58	M16	84.33
3900-4253	40	75	70	M16	95.15

BT 30 & 40 ER COLLET CHUCKS

- For CNC machines having BT taper spindles.
- Concentricity .0003".
- All critical surface are hardened and precision ground.

Draw Bar Thread: BT30 M12x1.75
BT40 M16x2.00

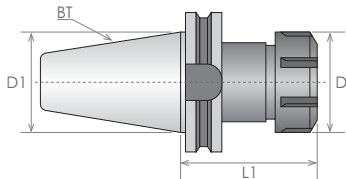

BT30 Item#	Type	Collet Range	Nut Style	Nut Dia. D	Gage Depth L	Price (F)
3900-7554	ER-16	.019~.406"	Hex	1.1"	2.76"	54.06
3900-7562	ER-25	.040~.629"	Spanner	1.7"	2.76"	54.06
3900-7566	ER-32	.078~.787"	Spanner	2.0"	2.76"	54.06
3900-7570	ER-40	.120~1.020"	Spanner	2.5"	3.15"	103.14

BT40 Item#	Type	Collet Range	Nut Style	Nut Dia. D	Gage Depth L1	Price (F)
3900-7604	ER-16	.019~.406"	Hex	1.1"	2.48"	69.56
3900-8604	ER-16	.019~.406"	Hex	1.1"	2.76"	87.78
3900-7608	ER-20	.040~.511"	Hex	1.4"	2.76"	47.92
3900-7612	ER-25	.040~.629"	Spanner	1.7"	2.36"	71.08
3900-8618	ER-32	3/32~3/4"	Spanner	2.0"	2.76"	87.78
3900-8620	ER-32	3/32~3/4"	Spanner	2.0"	4"	199.00

Pro-Series BT40 METRIC ER COLLET CHUCK SETS

- High precision collet chuck system suitable for all milling and drilling applications.
- Unique self-releasing system.
- Wide holding range.
- With fitted case.
- Accuracy to .0004", G6.3,15,000RPM.

ER-32		ER-25				
10PC SET INCLUDES 8-Collet: 4, 5, 6, 8, 10, 12, 16 & 20mm 1-Collet Chuck 1-Wrench		10C SET INCLUDES 8-Collet: 4, 5, 6, 8, 10, 12, 14 & 16mm 1-Collet Chuck 1-Wrench				
Item#	No.	Nut Style	Chuck Shank	Gage Length	Collet Set	Price (F)
3901-5101	ER-25	Spanner	BT40	3.94"	10	220.02
3901-5108	ER-32	Spanner	BT40	2.75"	10	232.23

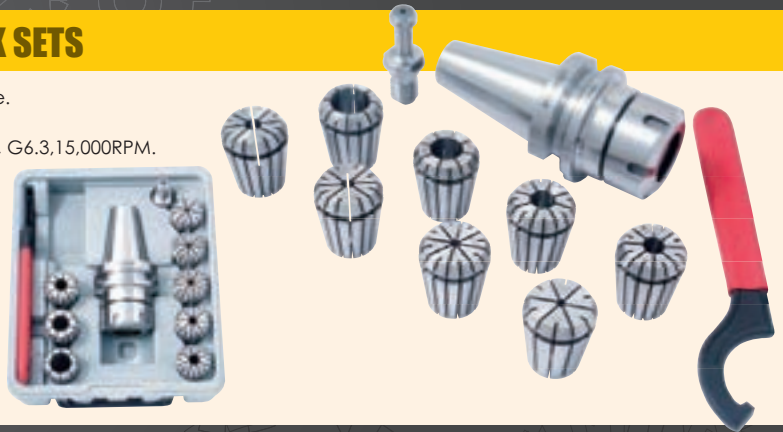

BT30 SK LYNDX STYLE SLIM COLLET CHUCKS

- Dual contacts of taper and flange.
- Increase spindle contact by 53% over standard holders.
- Prevent tools from pulling into spindle.
- Balanced to 30,000 RPM.

RUNOUT ≤ 5 MICRON at 4D



Limited Supply!

BT30 (Drawbar End M12x1.75)

Item#	Collet Series	Collet Range	H	C	Gage Depth L (mm)	Price (F)
3901-5490	SK10	0.069~0.393"	1.181~1.969"	1.083"	90	77.68
3901-5492	SK16	0.108~0.630"	1.772~2.756"	1.575"	90	77.68

Wrench for SK10 Item# 3900-0590 \$10.55(F)

BT40 SK LYNDX STYLE SLIM COLLET CHUCKS

- Dual contacts of taper and flange.
- Increase spindle contact by 53% over standard holders.
- Prevent tools from pulling into spindle.
- Balanced to 25,000 RPM.

RUNOUT ≤ 5 MICRON at 4D

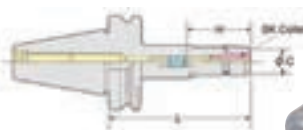

Limited Supply!

BT40 (Drawbar End M16x2.00)

Item#	Collet Series	Collet Range	H	C	Gage Depth L (mm)	Price (F)
3901-5496	SK10	0.069~0.393"	1.181~1.969"	1.083"	90	83.40
3901-5498	SK16	0.108~0.630"	1.575~2.756"	1.575"	90	83.40

Wrench for SK10 Item# 3900-0590 \$10.55(F)

ER COLLETS & SETS

Pro-Series HIGH ACCURACY ER SPRING COLLETS - AA GRADE 5 MICRON

Series	Major Dia.	Overall Length
ER-16	.670"	1.052"
ER-20	.830"	1.230"
ER-32	1.300"	1.578"



- Made of high grade SUJ2 steel.
- Hardened and precision ground 44-48HRC.
- Exceeds Federal specifications.
- Inside diameter ground to reach mirror finish increased grip force.
- Surface treated to reduce rust and improve hardness.
- Cryogenic treatment to significantly increase wear resistance.

Size/Range	ER-16 Item#	Price (F)	ER-20 Item#	Price (F)	ER-32 Item#	Price (F)
1/32" (.02~.04)	3901-5150	37.21				
1/16" (.04~.08)	3901-5151	37.21	3901-5180	37.21	3901-5239	40.40
3/32" (.08~.12)	3901-5152	37.21	3901-5181	37.21	3901-5240	40.40
1/8" (.12~.16)	3901-5153	37.67	3901-5182	37.21	3901-5241	40.40
3/16" (.16~.20)	3901-5154	37.21	3901-5183	37.21	3901-5242	40.40
7/32" (.20~.236)	3901-5155	37.21	3901-5184	37.21	3901-5243	40.40
1/4" (.236~.275)	3901-5156	37.67	3901-5185	37.21	3901-5244	40.91
5/16" (.275~.316)	3901-5157	37.21	3901-5186	37.21	3901-5245	40.40
11/32" (.316~.354)	3901-5158	36.60	3901-5187	37.21	3901-5246	40.40
3/8" (.354~.393)	3901-5159	37.67	3901-5188	37.21	3901-5247	40.91
13/32" (.393~.433)			3901-5189	37.21	3901-5248	40.40
7/16" (.433~.472)			3901-5190	37.21	3901-5249	40.40
1/2" (.472~.511)			3901-5191	37.21	3901-5250	40.91
17/32" (.511~.551)					3901-5251	42.03
9/16" (.551~.590)					3901-5252	40.40
5/8" (.590~.629)					3901-5253	40.40
21/32" (.629~.669)					3901-5254	40.40
11/16" (.669~.708)					3901-5255	40.40
23/32" (.708~.748)					3901-5256	40.40
3/4" (.748~.787)					3901-5257	40.91
25/32" (.748~.787)					3901-5258	40.40
13/16" (.787~.826)					3901-5259	40.40

Collet must be assembled into collet chuck nut before inserting into collet chuck!

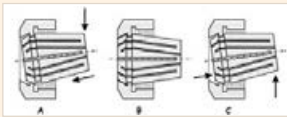

RUNOUT ≤ .0002"/.005MM
SUPERIOR FINISH

AA GRADE TOLERANCE: 5 MICRON

Pro-Series ER COLLET SETS - INCH & METRIC - AA GRADE 5 MICRON



Limited Supply!

INCH, ER-16
12 PC SET
3901-5320
\$32761
(F)

INCH, ER-20
14 PC SET
3901-5334
\$38206
(F)

INCH, ER-32
18 PC SET
3901-5355
\$53496
(F)

METRIC, ER-16
12 PC SET
3901-5325
\$32761
(F)

METRIC, ER-20
14 PC SET
3901-5338
\$38206
(F)

METRIC, ER-32
18 PC SET
3901-5358
\$53496
(F)

Pro-Series ER COLLET & RACK SETS - INCH - AA GRADE 5 MICRON

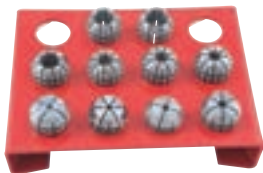

INCH, ER-16
10 PC SET
3901-5360
\$23455
(F)



INCH, ER-20
12 PC SET
3901-5364
\$27100
(F)



INCH, ER-32
18 PC SET
3901-5365
\$40541
(F)

ER SPRING COLLETS-COOLANT THRU

- Designed for use with cylindrical shank tools (no flats). Cutting tool should be inserted the full length of the collet. If these conditions are not met, coolant leakage may result.
- Collets meet DIN 6499B.

Series	Major Dia.	Overall Length
ER-16	.670"	1.052"
ER-20	.830"	1.230"
ER-25	1.020"	1.390"
ER-32	1.300"	1.578"
ER-40	1.620"	1.810"

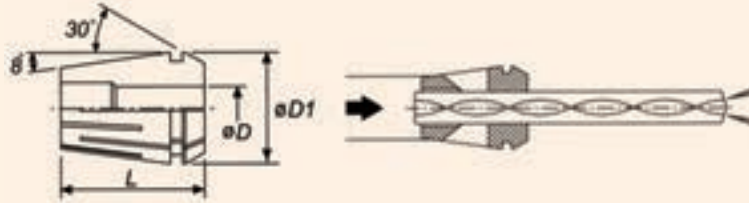

Size/Range	ER-16 Item#	Price (F)	ER-20 Item#	Price (F)	ER-25 Item#	Price (F)	ER-32 Item#	Price (F)	ER-40 Item#	Price (F)
1/8" (.12~.16)	3900-5566	15.96	3900-5583	16.74	3900-5753	20.24			3900-5773	24.44
3/16" (.16~.20)	3900-5568	15.96	3900-5584	16.74	3900-5754	20.24	3900-5542	30.19	3900-5774	24.44
7/32" (.20~.236)	3900-5570	15.96	3900-5585	16.74	3900-5755	20.24	3900-5543	30.19	3900-5775	24.44
1/4" (.236~.275)	3900-5572	15.96	3900-5586	16.74	3900-5756	20.24	3900-5544	30.19	3900-5776	24.44
5/16" (.275~.316)	3900-5574	15.96	3900-5587	16.74	3900-5757	20.24	3900-5545	30.19	3900-5777	24.44
11/32" (.316~.354)	3900-5576	15.96	3900-5588	16.74	3900-5758	20.24	3900-5546	30.19	3900-5778	24.44
3/8" (.354~.393)	3900-5578	15.96	3900-5589	16.74	3900-5759	20.24	3900-5547	30.19	3900-5779	24.44
13/32" (.393~.433)			3900-5590	16.74	3900-5760	20.24	3900-5548	30.19	3900-5780	24.44
7/16" (.433~.472)			3900-5591	16.74	3900-5761	20.24	3900-5549	30.19	3900-5781	24.44
1/2" (.472~.511)			3900-5592	16.74	3900-5762	20.24	3900-5550	30.19	3900-5782	24.44
17/32" (.511~.551)					3900-5763	20.24	3900-5551	30.19	3900-5783	24.44
9/16" (.551~.590)					3900-5764	20.24	3900-5552	30.19	3900-5784	24.44
5/8" (.590~.629)					3900-5765	20.24	3900-5553	30.19	3900-5785	24.44
21/32" (.629~.669)							3900-5554	30.19	3900-5786	24.44
11/16" (.669~.708)							3900-5555	30.19	3900-5787	24.44
23/32" (.708~.748)							3900-5556	30.19	3900-5788	24.44
3/4" (.748~.787)							3900-5557	30.19	3900-5789	24.44
25/32" (.748~.787)									3900-5790	24.44
13/16" (.787~.826)									3900-5791	24.44
27/32" (.826~.866)									3900-5792	24.44
7/8" (.866~.905)									3900-5793	24.44
15/16" (.905~.984)									3900-5794	24.44
31/32" (.944~.984)									3900-5795	24.44
1" (.984~1.020)									3900-5796	24.44

Collet must be assembled into collet chuck nut before inserting into collet chuck!

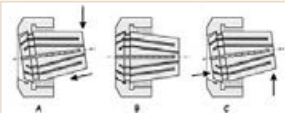

RUNOUT ≤ .0005"

Pro-Series ER SPRING COLLET & RACK SETS- METRIC - AA GRADE 5 MICRON

- Made of high grade alloy tool steel.
- Hardened and precision ground to 44-48HRC.
- Exceeds Federal specifications.
- Inside diameter ground to reach mirror finish for increased grip force.
- Surface treated to reduce rust and improve hardness.

RUNOUT ≤ .0002"/.005MM

Collet must be assembled into collet chuck nut before inserting into collet chuck!

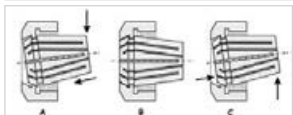

Series	Major Dia.	Overall Length
ER-16	.670"	1.052"
ER-32	1.300"	1.578"

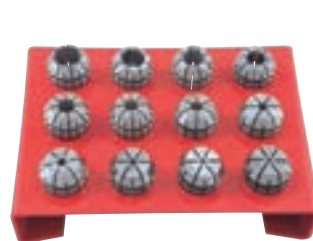

**METRIC, ER-16
12 PC SET
3901-5375**
\$261⁵⁸
(F)
1-10MM

**METRIC, ER-32
18 PC SET
3901-5378**
\$392⁹⁶
(F)
3-20MM

ER COLLETS & SETS

PRECISION ER SPRING COLLETS & SETS

- Made of high grade tool steel.
- Hardened and precision ground.
- Meets or exceeds Federal specifications.

Series	Major Dia.	Overall Length	Series	Major Dia.	Overall Length
ER-11	.453"	.709"	ER-25	1.020"	1.390"
ER-16	.670"	1.052"	ER-32	1.300"	1.578"
ER-20	.830"	1.230"	ER-40	1.620"	1.810"



Size/Range	ER-11 Item#	Price(F)	ER-16 Item#	Price(F)	ER-20 Item#	Price(F)	ER-25 Item#	Price(F)	ER-32 Item#	Price(F)	ER-40 Item#	Price(F)
1/32" (.02~.04)	3900-5142	12.36	3900-5150	12.97								
1/16" (.04~.08)	3900-5143	12.36	3900-5151	12.97	3900-5180	13.72	3900-5210	15.80	3900-5239	15.36		
3/32" (.08~.12)	3900-5144	12.36	3900-5152	12.97	3900-5181	13.72	3900-5211	15.80	3900-5240	15.36		
1/8" (.12~.16)	3900-5145	12.36	3900-5153	12.97	3900-5182	13.72	3900-5212	15.80	3900-5241	15.36	3900-5270	16.64
3/16" (.16~.20)	3900-5146	12.36	3900-5154	12.97	3900-5183	13.72	3900-5213	15.80	3900-5242	15.36	3900-5271	16.64
7/32" (.20~.236)	3900-5147	12.36	3900-5155	12.98	3900-5184	13.72	3900-5214	15.80	3900-5243	15.36	3900-5272	16.64
1/4" (.236~.275)	3900-5148	12.36	3900-5156	12.98	3900-5185	13.72	3900-5215	15.80	3900-5244	15.36	3900-5273	16.64
5/16" (.275~.316)			3900-5157	12.98	3900-5186	13.72	3900-5216	15.80	3900-5245	15.36	3900-5274	16.64
11/32" (.316~.354)			3900-5158	12.97	3900-5187	13.72	3900-5217	15.80	3900-5246	15.36	3900-5275	16.64
3/8" (.354~.393)			3900-5159	12.97	3900-5188	13.72	3900-5218	15.80	3900-5247	15.36	3900-5276	16.64
13/32" (.393~.433)					3900-5189	13.72	3900-5219	15.80	3900-5248	15.36	3900-5277	16.64
7/16" (.433~.472)					3900-5190	13.72	3900-5220	15.80	3900-5249	15.36	3900-5278	16.64
1/2" (.472~.511)					3900-5191	13.72	3900-5221	15.80	3900-5250	15.36	3900-5279	16.64
17/32" (.511~.551)							3900-5222	15.80	3900-5251	15.36	3900-5280	16.64
9/16" (.551~.590)							3900-5223	15.80	3900-5252	15.36	3900-5281	16.64
5/8" (.590~.629)							3900-5224	15.80	3900-5253	15.36	3900-5282	16.64
21/32" (.629~.669)									3900-5254	15.36	3900-5283	16.64
11/16" (.669~.708)									3900-5255	15.36	3900-5284	16.64
23/32" (.708~.748)									3900-5256	15.36	3900-5293	16.64
3/4" (.748~.787)									3900-5257	15.36	3900-5285	16.64
25/32" (.748~.787)									3900-5265	13.60	3900-5286	16.64
13/16" (.787~.826)									3900-5263	15.36	3900-5287	16.64
27/32" (.826~.866)											3900-5288	16.64
7/8" (.866~.905)											3900-5289	16.64
15/16" (.905~.984)											3900-5290	16.64
31/32" (.944~.984)											3900-5291	16.64
1" (.984~1.02)											3900-5292	16.64

Collet must be assembled into collet chuck nut before inserting into collet chuck!

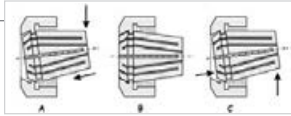

9 PC SET, ER-11
3900-5164
\$8499 (F)
1/32"~9/32" By 32nd

10 PC SET, ER-16
3900-5165
\$8749 (F)
1/32"~3/8", All Sizes Above

12 PC SET, ER-20
3900-5205
\$11649 (F)
1/16"~1/2", All Sizes Above

15 PC SET, ER-25
3900-5235
\$13648 (F)
1/16"~5/8", All Sizes Above

18 PC SET, ER-32
3900-5267
\$18689 (F)
3/32"~3/4" Only

24 PC SET, ER-40
3900-5299
\$35351 (F)
1/8"~1", All Sizes Above

ER SPRING COLLET SETS-METRIC

- Made of high grade tool steel.
- Hardened and precision ground.
- Meets or exceeds Federal specifications.

12 PC SET, ER-32
3903-5260
\$12434 (F)
3, 4, 5, 6, 8, 10, 12, 14, 15, 16, 18 & 20mm



10 PC SET, ER-25
3903-5230
\$8974 (F)
3, 4, 5, 6, 8, 10, 12, 14, 15 & 16mm

ER-32 SPRING COLLET SETS

- Made of high grade tool steel.
- Hardened and precision ground.
- Meets or exceeds Federal specifications.



6 PC SET, ER-32
3900-5166
\$6911 (F)
1/8"~3/4" By 8ths

11 PC SET, ER-32
3900-5168
\$13120 (F)
1/8"~3/4" By 16ths

18 PC SET, ER-32
3900-5267
\$18110 (F)
3/32"~3/4" Only

HARLINGEN® HIGH PERFORMANCE ER COLLETS - METRIC

HARLINGEN® ultra precision ER collets are made of special bearing steel, Grade GCr15, fully hardened and precisely ground by experienced craftsmen. Our powerful clamping ability and durability are ideal for boring, milling, drilling and tapping as well as grinding operations.

- Made of high-performance special bearing steel.
- Ideal for drilling, reaming and milling for high precision machining.
- Your choice for secure and rigid holding of drills of any size while retaining the highest concentricity within the range.
- 8 taper design enables maximum gripping power.
- All slits are spaced and ground evenly.
- Made of special bearing steel.

Collet must be assembled into collet chuck nut before inserting into collet chuck !

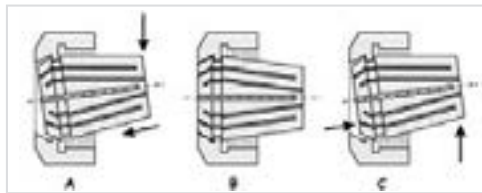

Ultra-Precision Made of Special Bearing Steel !

**DIN6499B
RUNOUT ≤ .0005"**

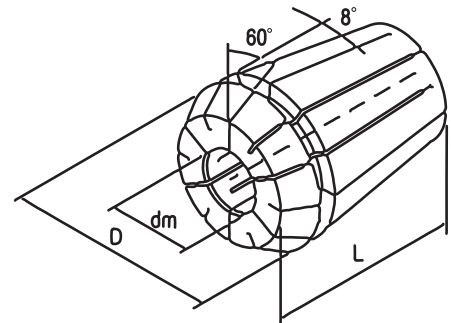

Series	Major Dia. D	Overall Length L
ER-16	17.0mm	27.5mm
ER-20	21.0mm	31.5mm
ER-25	26.0mm	34.0mm
ER-32	33.0mm	40.0mm

Size Range	ER-16 Item#	Price (F)	ER-20 Item#	Price (F)	ER-25 Item#	Price (F)	ER-32 Item#	Price (F)
3.0-2.0mm	9710-4011	12.45	9710-4019	12.45	9710-4030	13.03	9710-4044	13.65
4.0-3.0mm	9710-4012	12.45	9710-4020	12.45	9710-4031	13.03	9710-4045	13.65
5.0-4.0mm	9710-4013	12.45	9710-4021	12.45	9710-4032	13.03	9710-4046	13.65
6.0-5.0mm	9710-4014	12.45	9710-4022	12.45	9710-4033	13.03	9710-4047	13.65
7.0-6.0mm	9710-4015	12.45	9710-4023	12.45	9710-4034	13.03	9710-4048	13.65
8.0-7.0mm	9710-4016	12.45	9710-4024	12.45	9710-4035	13.03	9710-4049	13.65
9.0-8.0mm	9710-4017	12.45	9710-4025	12.45	9710-4036	13.03	9710-4050	13.65
10.0-9.0mm	9710-4018	12.45	9710-4026	12.45	9710-4037	13.03	9710-4051	13.65
11.0-10.0mm			9710-4027	12.45	9710-4038	13.03	9710-4052	13.65
12.0-11.0mm			9710-4028	12.45	9710-4039	13.03	9710-4053	13.65
13.0-12.0mm			9710-4029	12.45	9710-4040	13.03	9710-4054	13.65
14.0-13.0mm					9710-4041	13.03	9710-4055	13.65
15.0-14.0mm					9710-4042	13.03	9710-4056	13.65
16.0-15.0mm					9710-4043	13.03	9710-4057	13.65
17.0-16.0mm							9710-4058	13.65
18.0-17.0mm							9710-4059	13.65
19.0-18.0mm							9710-4060	13.65
20.0-19.0mm							9710-4061	13.65

SPINDLE TAPER WIPERS

- For all 30,40 & 50 tapers
- Maintains spindle accuracy and rigid contact
- Multiple usage on tool holder tapers NMTB, CAT and BT



Item#	Taper#	Price (F)
7016-0013	30	21.11
7016-0014	40	24.32
7016-0015	50	30.26

TANG SCREW FOR DRAWBAR END HOLDERS

- Precision made from tool steel, hardened.
- Metric thread.



Tang for draw bar thread type holders

Item#	Morse Taper	Thread	Dimension (mm)				Price (F)
			D	L	L1	L2	
3900-0789	MT1	M6x1.00	9.5	27	7.5	3	6.39
3900-0790	MT2	M10x1.50	12	30	7	4	6.83
3900-0791	MT3	M12x1.75	17	40	12	4	7.11
3900-0792	MT4	M16x2.00	24	46	13	5	7.92
3900-0793	MT5	M24x3.00	34	47	14	5	14.70

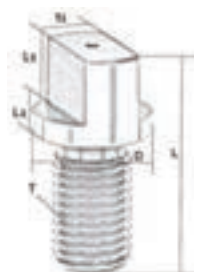

ER COLLET CHUCK NUTS

TYPE A HEX ER CHUCK NUTS



Type A

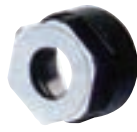

Type A (Bearing Type)

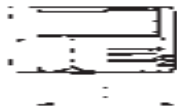

Fits	Thread	D (mm)	L (mm)	Type A Item#	Price (F)	Type A (Bearing) Item#	Price (F)
ER-11	M14 x 0.75	19	11.3	3900-0614	18.92	3900-0654	30.09
ER-16	M22 x 1.50	28	17.5	3900-0616	20.53	3900-0656	33.95
ER-20	M25 x 1.50	35	19	3900-0620	22.37	3900-0660	35.65

Pro-Series TYPE A 18,000 RPM ER CHUCK NUTS

- Balanced to 18,000 RPM
- Tolerance: .0003" Max.
- Material: 42 CrMo
- Hardness: HRC 50-52
- Thread Tolerance Class: 4H-Class



Item#	Fits	Thread	D (mm)	L (mm)	Price (F)
3900-0685	ER-11	M14 x 0.75	19	11.3	29.68
3900-0686	ER-16	M22 x 1.50	28	17.5	25.64

TYPE KM & UM SPANNER ER CHUCK NUTS



Type UM

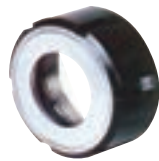

Type KM (Bearing Type)

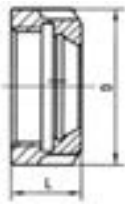

Fits	Thread	D (mm)	L (mm)	Type UM Item#	Price (F)	Type KM Item#	Price (F)
ER-25	M32 X 1.50	42	20	3900-0625	23.61	3900-0645	27.41
ER-32	M40 X 1.50	50	22.5	3900-0632	23.61	3900-0647	29.19
ER-40	M50 X 1.50	63	25.5	3900-0640	26.31	3900-0649	32.59
ER-50	M64 X 2.00	78	35.5	3900-0642	28.76	3900-0651	48.36

Pro-Series TYPE UM 18,000 RPM ER CHUCK NUTS

- Balanced to 18,000 RPM
- Tolerance: .0003" Max.
- Material: 42 CrMo
- Hardness: HRC 50-52
- Thread Tolerance Class: 4H-Class



Item#	Fits	Thread	D (mm)	L (mm)	Price (F)
3900-0688	ER-16	M22x1.5	32	17	28.84
3900-0689	ER-20	M25x1.5	35	19	28.84
3900-0690	ER-25	M32 X 1.50	42	20	27.42
3900-0691	ER-32	M40 X 1.50	50	22.5	26.62
3900-0692	ER-40	M50 X 1.50	63	25.5	30.30
3900-0693	ER-50	M64 X 2.00	78	35.5	49.02

ER CHUCK NUTS-Mini-Castle Nut FOR MINI TYPE SHANKS ONLY

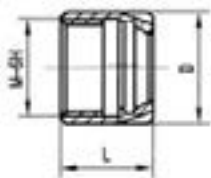

Fits	Item#	Thread	D(mm)	L (mm)	Price (F)
ER-8 Mini	3900-0671	M10 x 0.75	12	12	15.99
ER-11 Mini	3900-0673	M13 x 0.75	16	12	15.99
ER-16 Mini	3900-0675	M19 x 1.00	22	18	15.99
ER-20 Mini	3900-0677	M24 x 1.00	28	19	15.99
ER-25 Mini	3900-0679	M30 x 1.00	35	20	15.99

Pro-Series TYPE M 18,000 RPM ER CHUCK NUTS

- Balanced to 18,000 RPM
- Tolerance: .0003" Max.
- Material: 42 CrMo
- Hardness: HRC 50-52
- Thread Tolerance Class: 4H-Class



Item#	Fits	Thread	D (mm)	L (mm)	Price (F)
3900-0680	ER-11Mini	M13x.75	16	12	27.13
3900-0681	ER-16Mini	M19x1.0	22	18	26.62
3900-0682	ER-20Mini	M24x1.0	28	19	27.13

ER CHUCK CASTLE WRENCHES-Mini FOR MINI NUTS

- Castle Wrench.

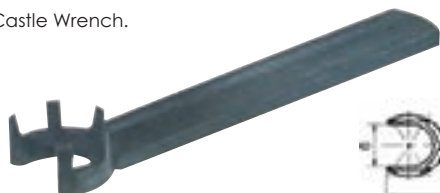

Item#	Fits	Open B (mm)	OAL L (mm)	Price (F)
3900-0606	ER-8 Mini	7.5	70	16.38
3900-0607	ER-11 Mini	11	90	16.38
3900-0608	ER-16 Mini	15	110	16.38
3900-0609	ER-20 Mini	19.5	120	16.70
3900-0610	ER-25 Mini	25	130	16.70

ER COLLET CHUCK WRENCHES & RACKS

ER CHUCK HEX WRENCHES FOR TYPE A NUT

- For hex ER chuck nuts.



Item#	Fits	Open B (mm)	OAL L (mm)	Price (F)
3900-0591	ER-11	17	110	9.60
3900-0593	ER-16	25	110	11.69
3900-0592	ER-20	30	160	10.55

ER CHUCK SLOTTED WRENCHES FOR TYPE KM&UM NUT

- For ER chuck nuts with slots.



Item#	Fits	Open B (mm)	OAL L (mm)	Price (F)
3900-0601	ER-25	37	210	15.92
3900-0602	ER-32	45	250	18.36
3900-0603	ER-40	58	290	26.97
3900-0605	ER-50	72	350	31.96

ER CHUCK SPANNER HOOK WRENCHES FOR TYPE KM&UM NUT

- For ER chuck nuts with slots.



Item#	Fits	Open (mm)	OAL L (mm)	Price (F)
3900-0594	ER-25	38-42	168	9.38
3900-0595	ER-32	45-52	190	12.03
3900-0596	ER-40	55-63	210	14.03
3900-0599	ER-50	78-85	240	19.97

COLLET RACK-5C, ER32

- Holds 8 collets: 5C, ER32 or others.
- 4 mounting holes: 3.5" & 5.5" apart.
- Supplied with mounting hardware.
- Made from durable ABS material, heavy duty.



3900-1609
\$19.41 (F)

COLLETS ARE NOT INCLUDED

ER COLLET RACKS

- Holds ER collets.
- Made from heavy duty gage steel.
- Supplied with mounting hardware.

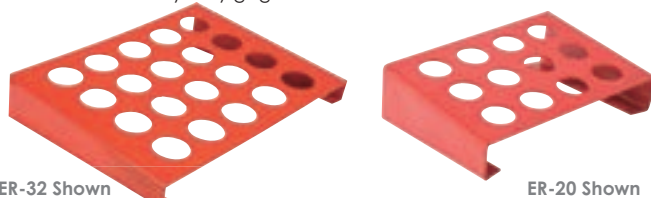

Item#	TYPE	HOLD COLLET	FOOTPRINT	Price (F)
3900-8671	ER-11	12	70x100mm	22.07
3900-8672	ER-16	12	80x110mm	27.08
3900-8676	ER-20	12	100x140mm	40.10
3900-8680	ER-25	15	130x190mm	50.65
3900-8684	ER-32	20	200x260mm	56.54
3900-8688	ER-40	24	245x360mm	68.36

ER COLLET RACKS

- Holds ER collets.
- Heavy duty gage steel.
- Supplied with mounting hardware.



Item#	TYPE	HOLD COLLET	FOOTPRINT	Price (F)
3900-5171	ER-11	13	110x160mm	25.08
3900-5172	ER-16	8	110x180mm	25.08
3900-5174	ER-20	12	160x185mm	37.10
3900-5175	ER-25	15	180x300mm	68.71
3900-5176	ER-32	11	180x400mm	68.71
3900-5178	ER-40	15	250x360mm	78.00

8PC EXPANDING ARBOR SETS

- Chuck the shank of the expanding mandrel in a collet, jaw chuck, or fixture.
- With an Allen wrench tighten the hex draw bolt until it expands. Then machine the slotted part larger than bore of part.
- Loosen hex draw bolt, position part, tighten draw screw. The part is now chucked and ready for machining.
- Can be used with standard collets, vises, jaw chucks and many other special fixtures.
- Multiple expanding mandrels are also used in other special fixtures for holding multiple work pieces "side by side".

SET INCLUDES:

Sizes shown, Allen wrench and wood block.

Item#	Sizes Included	Price (F)
3906-4006	1/4, 3/8, 1/2, 5/8, 3/4, 7/8, 1 & 1-1/4"	48.60
3906-4008	6, 10, 12, 16, 19, 22, 25 & 32mm	48.60

See page 286 for additional arbors & sets.



ER COLLET CHUCKS

STRAIGHT SHANK ER COLLET CHUCKS

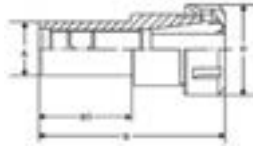

- Precision made with 0.0008" T.I.R.
- For heavy duty jobs.

Item#	Shank Ax B1	Type	Capacity	Nut Style	(mm) B	(mm) D	Price (F)
3900-5106	5/8x2-1/2"	ER-11	.02~.275"	Hex	88.9	19	52.03
3900-7692	16mmx4"	ER-11	.02~.275"	Mini	127	19	32.75
3900-5107	3/4x2-1/2"	ER-11	.02~.275"	Hex	88.9	19	45.59
3900-5108	3/4x4"	ER-11	.02~.275"	Hex	127	19	96.49
3900-5109	3/4x2-1/2"	ER-16	.02~.393"	Hex	103.5	28	43.67
3900-5110	3/4x4"	ER-16	.02~.393"	Hex	141.6	28	45.53
3900-5111	3/4x6"	ER-16	.02~.393"	Hex	192.4	28	60.05
3900-7694	20mmx4"	ER-16	.02~.393"	Hex	141.6	28	96.49
3900-5112	3/4x2-1/2"	ER-20	.04~.511"	Hex	104	34	66.33
3900-5116	3/4x4"	ER-20	.04~.511"	Hex	142.1	34	49.13
3900-5113	3/4x6"	ER-20	.04~.511"	Hex	192.9	34	74.43
3900-5115	3/4x2"	ER-25	.04~.629"	Spanner	101.8	42	54.59
3900-5114	3/4x4"	ER-25	.04~.629"	Spanner	152.6	42	65.51
3900-5118	1x2"	ER-32	.08~.787"	Spanner	101.5	50	58.79
3900-5122	1-1/4x6"	ER-32	.08~.787"	Spanner	201.5	50	66.78

NMTB 30 & 40 SHANK ER COLLET CHUCKS

- Made of high grade tool steel.
- Hardened and precision ground.
- Meets or exceeds Federal specifications.

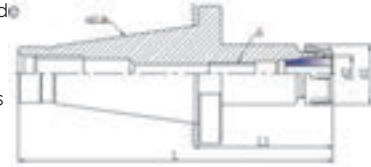

Item#	Shank	Type	Nut Style	L	(mm) L1	d1	Drawbar End	Price (F)
3900-5083	#30	ER-32	Spanner	128.4	60	50	1/2"~13	63.06
3900-5084	#30	ER-40	Spanner	138.4	70	63	1/2"~13	61.90
3900-5088	#40	ER-16	Hex	138.4	45	28	5/8"~11	59.17
3900-5090	#40	ER-32	Spanner	153.4	60	50	5/8"~11	70.26
3900-5091	#40	ER-40	Spanner	163.4	70	63	5/8"~11	63.71

Pro-Series NMTB 30 & 40 SHANK ER COLLET CHUCKS

- Made of high grade alloy steel
- Tolerance: .0003" Max.

SUPERIOR FINISH & CRAFTSMANSHIP

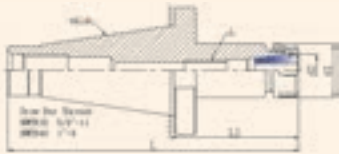

Item#	Shank	Type	Nut Style	L	(mm) L1	d1	Drawbar End	Price (F)
3901-5083	#30	ER-32	Spanner	128.4	60	50	1/2"~13	95.83
3901-5084	#30	ER-40	Spanner	138.4	70	63	1/2"~13	102.22
3901-5088	#40	ER-16	Hex	138.4	45	28	5/8"~11	93.70
3901-5090	#40	ER-32	Spanner	153.4	60	50	5/8"~11	102.22
3901-5091	#40	ER-40	Spanner	163.4	70	63	5/8"~11	111.79

Pro-Series STRAIGHT SHANK BALANCED ER COLLET CHUCKS

- Made of high grade alloy steel.
- Premium hardened & all ground body for extended tool life.

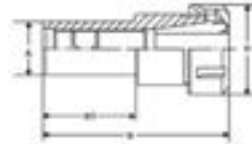

**MAX. RPM: 18,000
T.I.R. ≤ .0003"
SUPERIOR FINISH**

Item#	Type	Shank Ax B1	Nut Style	B	(mm) D	Price (F)
3900-2080	ER-11	5/8X2-1/2"	Hex	3.457"	19	83.64
3900-2082	ER-11	3/4X4"	Hex	4.957"	19	90.65
3900-2083	ER-16	3/4x2-1/2"	Hex	4.087"	28	83.68
3900-2084	ER-16	3/4x4"	Hex	5.587"	28	90.65
3900-2085	ER-16	3/4x6"	Hex	7.587"	28	104.62
3900-2086	ER-20	3/4X2-1/2"	Hex	4.476"	34	82.39
3900-2088	ER-20	3/4X4"	Hex	5.976"	34	90.65
3900-2089	ER-20	3/4X6"	Hex	7.976"	34	104.62
3900-2091	ER-25	3/4X2"	Spanner	4.232"	42	83.68
3900-2092	ER-25	3/4X4"	Spanner	6.232"	42	90.65
3900-2094*	ER-32	1X2"	Spanner	4.252"	50	77.77
3900-2095*	ER-32	1X4"	Spanner	6.252"	50	84.35

*Limited Supply

R8 SHANK ER COLLET CHUCKS

- Made of high grade tool steel.
- Hardened and precision ground.
- Meets or exceeds Federal specifications.
- Thread of Drawbar End: 7/16" -20

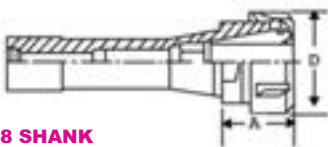

R-8 SHANK

Item#	Type	Nut Style	(Inch) A	D	Price (F)
3900-5061	ER-16	Hex	1.50	1.10	52.74
3900-5066	ER-32	Spanner	1.57	1.97	50.99
3900-5069	ER-40	Spanner	2.76	2.48	54.93



Pro-Series R8 Shank ER Collet Chucks

- Made of high grade alloy steel
- Premium hardened & all ground body for extended tool life.
- Thread of Drawbar End: R8- 7/16" -20

**R-8 SHANK
MAX. RPM: 8,000
T.I.R. ≤ .0002"
SUPERIOR FINISH**

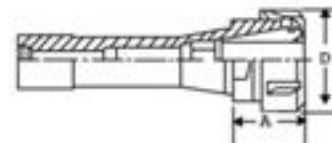

Item#	Type	Nut Style	(Inch) A	D	Price (F)
3901-5061*	ER-16	Hex	1.50	1.10	84.17
3901-5063	ER-20	Hex	1.50	1.38	99.82
3901-5064*	ER-25	Spanner	1.57	1.66	91.50
3901-5066	ER-32	Spanner	1.57	1.97	114.37
3901-5069	ER-40	Spanner	2.76	2.48	99.82

*Limited Supply



CAT 40 ER COLLET CHUCKS

- For CNC machines having CAT 40 taper spindles.
- Hardened and precision ground.

CAT-40 (DRAWBAR END: 5/8" ~11)

T.I.R. ≤ 0.005mm

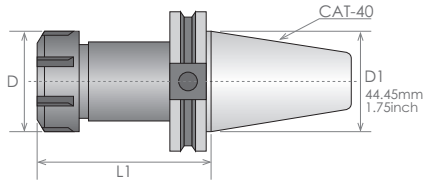

Item#	Type	Collet Range	Nut Style	Nut Dia. D	Gage Depth L1	Price (F)
3900-4362	ER-16	0.019~0.406"	Hex	1.1"	2.50"	64.87
3900-4361	ER-16	0.019~0.406"	Hex	1.1"	3.50"	64.87
3900-2060*	ER-16	0.019~0.406"	Hex	1.1"	2.76"	90.75
3900-2061*	ER-16	0.019~0.406"	Hex	1.1"	4.00"	87.80
3900-2028	ER-20	0.040~0.511"	Hex	1.4"	2.75"	68.52
3900-2039*	ER-20	0.040~0.511"	Hex	1.4"	4.00"	45.36
3900-2528	ER-25	0.040~0.629"	Spanner	1.7"	2.75"	57.74
3900-2539*	ER-25	0.040~0.629"	Spanner	1.7"	4.00"	58.98
3900-2073*	ER-32	0.078~0.787"	Spanner	2.0"	2.76"	87.80
3900-4369	ER-32	0.078~0.787"	Spanner	2.0"	3.20"	67.74
3900-4364*	ER-32	0.078~0.787"	Spanner	2.0"	4.00"	53.83
3900-4028	ER-40	0.120~1.020"	Spanner	2.5"	2.75"	72.18
3900-4039*	ER-40	0.120~1.020"	Spanner	2.5"	4.00"	49.30

*Limited Supply

BT 30 & 40 ER COLLET CHUCKS

- For CNC machines having BT taper spindles.
- Concentricity .0003".
- All critical surface are hardened and precision ground.

**Draw Bar Thread: BT30 M12x1.75
BT40 M16x2.00**

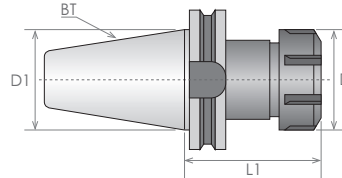

Item#	Type	Collet Range	Nut Style	Nut Dia. D	Gage Depth L1	Price (F)
3900-7554	ER-16	.019~.406"	Hex	1.1"	2.76"	54.06
3900-7562	ER-25	.040~.629"	Spanner	1.7"	2.76"	54.06
3900-7566	ER-32	.078~.787"	Spanner	2.0"	2.76"	54.06
3900-7570	ER-40	.120~1.020"	Spanner	2.5"	3.15"	103.14

Item#	Type	Collet Range	Nut Style	Nut Dia. D	Gage Depth L1	Price (F)
3900-7604*	ER-16	.019~.406"	Hex	1.1"	2.48"	69.56
3900-8604*	ER-16	.019~.406"	Hex	1.1"	2.76"	87.78
3900-7608*	ER-20	.040~.511"	Hex	1.4"	2.76"	47.92
3900-7612*	ER-25	.040~.629"	Spanner	1.7"	2.36"	71.08
3900-8618*	ER-32	3/32~3/4"	Spanner	2.0"	2.76"	87.78
3900-8620*	ER-32	3/32~3/4"	Spanner	2.0"	4"	199.00

*Limited Supply

MT SHANK ER COLLET CHUCKS

- Made of high grade tool steel.
- Hardened and precision ground.
- Meets or exceeds Federal specifications.

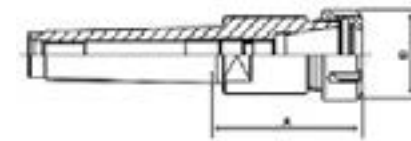

Item#	Shank Type	Nut Style	Drawbar End	A (mm)	D (mm)	Price(F)	
3900-5072	MT2	ER-20	Hex	3/8"~16	43	34	46.40
3900-5073	MT2	ER-25	Spanner	3/8"~16	47	42	63.87
3900-5077	MT3	ER-32	Spanner	3/8"~16	70	50	50.22
3900-5078	MT3	ER-40	Spanner	3/8"~16	80	63	61.64
3900-5079	MT4	ER-40	Spanner	5/8"~11	82	63	68.24

5C ER32 COLLET CHUCK

- 5C ER32 collet chuck.
- Made with DIN6499B (0.0005") Run-Out Tolerance.
- Holds all ER32 collets.
- Drawbar : 5C collet standard.
- Hardened and precision ground.
- Half-moon spanner wrench included.

3900-5099
\$81.89
(F)



Jacobs Taper ER COLLET SLEEVES & DRILL CHUCKS

- ER collet sleeves provide rigid & accurate holding of ID tooling. These collet sleeves feature ground shanks and tapers.
- Compatible with standard Jacobs taper spindles.
- Precision ground & hardened for accuracy and precision
- Can be used for coolant-thru applications
- Superior to keyed and keyless drill chucks in concentricity and holding power.



3903-6010 Shown

**MAX. RPM: 8,000
T.I.R. ≤ .0002"
SUPERIOR FINISH**

Item#	Type	Female JT Taper	Nut Style	SHANK DIA. D1	(mm) SHANK L1	OAL L2	Price (F)
3903-6010	ER-16	JT2	Hex	26	45	65	22.98
3903-6014	ER-20	JT2	Hex	26	45	65	22.98
3903-6018	ER-25	JT2	Spanner	32	46	67	25.73
3903-6050	ER-16	JT33	Hex	26	38	65	29.41
3903-6054	ER-20	JT33	Hex	26	38	65	29.41
3903-6058	ER-25	JT33	Spanner	32	40	72	32.17
3903-6062	ER-32	JT33	Spanner	40	48	71	34.92
3903-6082	ER-32	JT6	Spanner	40	50	73	27.57

Additional sizes shown on page 237

ER COLLET CHUCK SETS

ER SPRING COLLET CHUCK SETS

- High precision collet chuck system suitable for all milling and drilling applications.
- Unique self-releasing system.
- Wide holding range.
- With fitted case.
- Accuracy to .0005".



ER-11
<p>• 9PC SET INCLUDES</p> <p>7-Collet: 1/16, 3/32, 1/8, 3/16, 7/32, 1/4 & 5/16"</p> <p>1-Collet Chuck 1-Wrench</p>

ER-25
<p>• 10PC SET INCLUDES</p> <p>8-Collet 4, 5, 6, 8, 10, 12, 14 & 16mm</p> <p>1-Collet Chuck 1-Wrench</p>
<p>• 12PC SET INCLUDES</p> <p>10-Collet 3/32, 1/8, 3/16, 1/4, 5/16, 3/8, 7/16, 1/2, 9/16 & 5/8"</p> <p>1-Collet Chuck 1-Wrench</p>

ER-32
<p>• 8PC SET INCLUDES</p> <p>6-Collet 1/4, 5/16, 3/8, 1/2, 5/8 & 3/4"</p> <p>1-Collet Chuck 1-Wrench</p>
<p>• 10PC SET INCLUDES</p> <p>8-Collet 4, 5, 6, 8, 10, 12, 16 & 20mm</p> <p>1-Collet Chuck 1-Wrench</p>

ER-16
<p>• 11PC SET INCLUDES</p> <p>9-Collet 1/16, 3/32, 1/8, 3/16, 7/32, 1/4, 5/16, 11/32 & 3/8"</p> <p>1-Collet Chuck 1-Wrench</p>

<p>• 17PC SET INCLUDES</p> <p>15-Collet 1/16, 3/32, 1/8, 3/16, 7/32, 1/4, 5/16, 11/32, 3/8, 13/32, 7/16, 1/2, 17/32, 9/16 & 5/8"</p> <p>1-Collet Chuck 1-Wrench</p>
--

<p>• 14PC SET INCLUDES</p> <p>12-Collet 1/16, 3/32, 1/8, 3/16, 1/4, 5/16, 3/8, 7/16, 1/2, 9/16, 5/8 & 13/16"</p> <p>1-Collet Chuck 1-Wrench</p>
<p>• 20PC SET INCLUDES</p> <p>18-Collet 3/32, 1/8, 3/16, 7/32, 1/4, 5/16, 11/32, 3/8, 13/32, 7/16, 1/2, 17/32, 9/16, 5/8, 21/32, 11/16, 23/32 & 3/4"</p> <p>1-Collet Chuck 1-Wrench</p>

ER-40		
<p>• 10PC SET INCLUDES</p> <p>8-Collet 1/8, 1/4, 3/8, 1/2, 5/8, 3/4, 7/8 & 1"</p> <p>1-Collet Chuck 1-Wrench</p>	<p>• 17PC SET INCLUDES</p> <p>15-Collet 1/8, 3/16, 1/4, 5/16, 3/8, 7/16, 1/2, 9/16, 5/8, 11/16, 3/4, 13/16, 7/8, 15/16 & 1"</p> <p>1-Collet Chuck 1-Wrench</p>	<p>• 25PC SET INCLUDES</p> <p>23-Collet 1/8, 3/16, 7/32, 1/4, 5/16, 11/32, 3/8, 13/32, 7/16, 1/2, 17/32, 9/16, 5/8, 21/32, 11/16, 3/4, 25/32, 13/16, 27/32, 7/8, 15/16, 31/32 & 1"</p> <p>1-Collet Chuck 1-Wrench</p>

Item#	Type	Collet Set	Size Range	Chuck Shank	Nut Style	Gage Length	Price (E)
3900-1172	ER-11	9	1/16~5/16"	1/2"	Mini	---	81.41
3900-1174	ER-11	9	1/16~5/16"	3/4x2-1/2"	Hex	---	94.52
3900-1176	ER-11	9	1/16~5/16"	3/4x2-1/2"	Mini	---	88.25
3900-1177	ER-11	9	1/16~5/16"	3/4x4"	Mini	---	90.23
3900-1178	ER-11	9	1/16~5/16"	3/4x6"	Hex	---	122.93
3900-1672	ER-16	11	1/16~3/8"	3/4"x4"	Hex	---	134.06
3900-0501	ER-16	11	1/16~3/8"	R8	Hex	---	156.03
3900-4014	ER-16	11	1/16~3/8"	CAT40	Hex	2.75"	168.45
3900-2573	ER-25	17	1/16~5/8"	3/4"x2-1/2"	Spanner	---	154.61
3900-0502	ER-25	12	3/32~5/8"	MT2	Spanner	1.85"	149.21
3901-5101	ER-25	10	4~16mm	BT40	Spanner	2.75"	220.02
3900-4023	ER-25	17	1/16~5/8"	CAT40	Spanner	2.75"	185.61
3900-7530	ER-32	20	3/32~3/4"	3/4"x4"	Spanner	---	173.07
3900-0507	ER-32	8	1/4~3/4"	R8	Spanner	---	126.46
3900-0508	ER-32	14	1/16~13/16"	R8	Spanner	---	187.69
3900-0503	ER-32	14	1/16~13/16"	MT3	Spanner	2.75"	160.86
3900-5300	ER-32	14	1/16~13/16"	#30	Spanner	2.36"	163.87
3900-0505	ER-32	14	1/16~13/16"	#40	Spanner	2.75"	151.98
3901-5108	ER-32	10	4~20mm	BT40	Spanner	2.75"	232.23
3900-4029	ER-32	20	3/32~3/4"	CAT40	Spanner	3.20"	219.45
3900-7538	ER-40	17	1/8~1"	3/4x3"	Spanner	---	195.94
3900-0004	ER-40	10	1/8~1"	R8	Spanner	2.76"	127.23
3900-0005	ER-40	17	1/8~1"	R8	Spanner	2.76"	208.68
3900-0531	ER-40	17	1/8~1"	MT3	Spanner	3.15"	204.19
3900-0504	ER-40	17	1/8~1"	MT4	Spanner	2.75"	198.14
3900-5301	ER-40	17	1/8~1"	#30	Spanner	2.36"	261.96
3900-0538	ER-40	10	1/8~1"	#40	Spanner	2.36"	157.11
3900-0540	ER-40	17	1/8~1"	#40	Spanner	2.36"	208.68
3900-4042	ER-40	25	1/8~1"	CAT40	Spanner	2.75"	274.31

Pro-Series ER SPRING COLLET CHUCK SETS

- High precision collet chuck system suitable for all milling and drilling applications.
- Unique self-releasing system.
- Wide holding range.
- With fitted metal case.
- Accuracy to .0003".

SUPERIOR CRAFTSMANSHIP



ER-11

• 9PC SET INCLUDES

- 7-Collet: 1/16, 3/32, 1/8, 3/16, 7/32, 1/4 & 5/16"
- 1-Collet Chuck
- 1-Wrench

ER-16

• 11PC SET INCLUDES

- 9-Collet: 1/16, 3/32, 1/8, 3/16, 7/32, 1/4, 5/16, 11/32 & 3/8"
- 1-Collet Chuck
- 1-Wrench

ER-32

• 20PC SET INCLUDES

- 18-Collet
3/32, 1/8, 3/16, 7/32, 1/4, 5/16, 11/32, 3/8, 13/32, 7/16, 1/2, 17/32, 9/16, 5/8, 21/32, 11/16, 23/32 & 3/4"
- 1-Collet Chuck
- 1-Wrench

• 14PC SET INCLUDES

- 12-Collet
1/16, 3/32, 1/8, 3/16, 1/4, 5/16, 3/8, 7/16, 1/2, 9/16, 5/8 & 13/16"
- 1-Collet Chuck
- 1-Spanner Wrench

ER-25

• 12PC SET INCLUDES

- 10-Collet
3/32, 1/8, 3/16, 1/4, 5/16, 3/8, 7/16, 1/2, 9/16 & 5/8"
- 1-Collet Chuck
- 1-Wrench

ER-40

• 17PC SET INCLUDES

- 15-Collet
1/8, 3/16, 1/4, 5/16, 3/8, 7/16, 1/2, 9/16, 5/8, 11/16, 3/4, 13/16, 7/8, 15/16 & 1"
- 1-Collet Chuck
- 1-Wrench

• 25PC SET INCLUDES

- 23-Collet
1/8, 3/16, 7/32, 1/4, 5/16, 11/32, 3/8, 13/32, 7/16, 1/2, 17/32, 9/16, 5/8, 21/32, 11/16, 3/4, 25/32, 13/16, 27/32, 7/8, 15/16, 31/32 & 1"
- 1-Collet Chuck
- 1-Wrench

Item#	Type	Collet Set	Size Range	Chuck Shank	Nut Style	Gage Length	Price (E)
3900-1173	ER-11	9	1/16~5/16"	1/2"	Hex	---	206.02
3900-1175*	ER-11	9	1/16~5/16"	3/4x8"	Hex	---	148.96
3900-4016	ER-16	11	1/16~3/8"	CAT40	Hex	2.50"	304.78
3900-1675	ER-16	11	1/16~3/8"	3/4x6"	Hex	---	265.29
3900-4025	ER-25	12	3/32~5/8"	CAT40	Spanner	2.75"	421.57
3900-2575	ER-25	17	1/16~5/8"	3/4x4"	Spanner	---	390.14
3900-4050	ER-25	12	3/32~5/8"	MT2	Spanner	2.50"	183.33
3900-4032	ER-32	20	3/32~3/4"	CAT40	Spanner	3.20"	451.11
3900-7532	ER-32	20	3/32~3/4"	3/4x4"	Spanner	---	451.24
3900-4052	ER-32	14	1/16~13/16"	MT3	Spanner	2.75"	226.26
3900-4060	ER-32	14	1/16~13/16"	NMTB #30	Spanner	2.36"	233.91
3900-4040	ER-40	25	1/8~1"	CAT40	Spanner	2.75"	555.25
3900-4054	ER-40	17	1/8~1"	MT3	Spanner	3.20"	289.48
3900-4056	ER-40	17	1/8~1"	MT4	Spanner	3.20"	292.82
3900-4062	ER-40	17	1/8~1"	NMTB #30	Spanner	2.75"	312.78

*Limited Supply

ER COLLET FIXTURES & ACCESSORIES

ER COLLET FIXTURES-Plain Back

- Mount to your choice of backplate for using on a lathe or could be used as a fixture on a milling table.
- Concentricity: .04mm/ .00016"

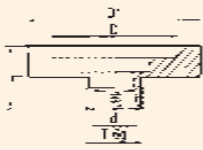

Item#	Type	(mm)			No. of Bolt Hole	Bolt Hole Size	Price (F)
		D1	D	L			
3901-5016	ER-16	45	22	25	4	5	85.00
3901-5025	ER-25	102	52	36	3	M10	96.87
3901-5032	ER-32	80	55	42	3	M6	92.15
3901-5033	ER-32	100	72	42	3	M8	94.86
3901-5034	ER-32	130	100	42	3	M8x1.25	97.67
3901-5035	ER-32	160	130	42	3	M8x1.25	185.65
3901-5036	ER-40	100	72	42	3	M8	107.04
3901-5038	ER-40	132	100	42	3	M10	123.73

ER-40 COLLET CHUCK FIXTURE-Direct Mount

- Mount to D1 spindle of lathe.
- Concentricity .0002"

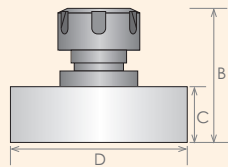

Item#	Type	D	Mount	B	C	Price (F)
3901-5041	ER-40	125mm	D1-3	54.9mm	23mm	119.64
3901-5042	ER-40	125mm	D1-4	54.9mm	23mm	121.47

HEX / SQUARE ER COLLET BLOCKS

- Block Dimension: 1-3/4 x 1-3/4 x Height.
- For fast set-ups on CNC machines.
- For parallel, square or hex shapes as well as for cross hole drilling at 60°, 90° or 120°.
- Made of tool steel hardened and ground to .0005" flatness, squareness and parallelism.
- Through hole allows for long parts to be machined.
- May be used standing upright.
- Uses standard ER collets.
- ER nut included.



Item#	Shape	ER Collet	Block Height	Price (F)
3900-5123	Square	ER-25	2.7	43.11
3900-5124	Square	ER-32	2.8	42.10
3900-5125	Square	ER-40	3.2	45.95
3900-5127	Hex	ER-25	2.7	43.88
3900-5128	Hex	ER-32	2.8	43.11
3900-5129	Hex	ER-40	3.2	45.95

Jacobs Taper ER COLLET SLEEVES & DRILL CHUCKS

- ER collet sleeves provide rigid & accurate holding of ID tooling. These collet sleeves feature ground shanks and tapers.
- Compatible with standard Jacobs taper spindles.

- Precision ground & hardened for accuracy and precision
- Can be used for coolant-thru applications
- Superior to keyed and keyless drill chucks in concentricity and holding power.



3903-6010 Shown
MAX. RPM: 8,000
T.I.R. < .0002"
SUPERIOR FINISH

Item#	Type	Female JT Taper	Nut Style	SHANK DIA. D1	(mm) SHANK L1	OAL L2	Price (F)
3903-6010	ER-16	JT2	Hex	26	45	65	22.98
3903-6014	ER-20	JT2	Hex	26	45	65	22.98
3903-6018	ER-25	JT2	Spanner	32	46	67	25.73
3903-6022	ER-32	JT2	Spanner	40	40	72	27.57
3903-6028	ER-16	JT3	Hex	32	45	72	22.98
3903-6032	ER-20	JT3	Hex	32	45	72	22.98
3903-6036	ER-25	JT3	Spanner	32	56	77	25.73
3903-6040	ER-32	JT3	Spanner	40	45	77	28.86
3903-6050	ER-16	JT33	Hex	26	38	65	29.41
3903-6054	ER-20	JT33	Hex	26	38	65	29.41
3903-6058	ER-25	JT33	Spanner	32	40	72	32.17
3903-6062	ER-32	JT33	Spanner	40	48	71	34.92
3903-6070	ER-16	JT6	Hex	25	38	65	22.98
3903-6074	ER-20	JT6	Hex	26	38	65	22.98
3903-6078	ER-25	JT6	Spanner	32	38	72	25.73
3903-6082	ER-32	JT6	Spanner	40	50	73	27.57

SK HOLDERS & ACCESSORIES - LYNDEX STYLE

BT30 SK SLIM COLLET CHUCKS - LYNDEX STYLE

- Dual contacts of taper and flange.
- Increase spindle contact by 53% over standard holders.
- Prevent tools from pulling into spindle.
- BT-30 Balanced to 30,000 RPM.

Limited Supply!



RUNOUT ≤ 5 MICRON at 4D

BT30 (Drawbar End M12x1.75)

Item#	Collet Series	Collet Range	H	C	Gage Depth L (mm)	Price (F)
3901-5490	SK10	0.069~0.393"	1.181~1.969"	1.083"	90	77.68
3901-5492	SK16	0.108~0.630"	1.772~2.756"	1.575"	90	77.68

SK SLIM COLLET CHUCK NUTS - LYNDEX STYLE

- For SK-10 or SK-16 collet chucks.
- Holds SK-10 or SK-16 style collets.
- Economical.



Item#	Collet Series	Nut Dia.	Nut Length	Nut Thread	Price (F)
3901-5555	SK10	27.1mm	24mm	M21.5x1.0	26.64
3901-5558	SK16	40.0mm	31mm	M32x1.5	26.64

SK10 SK STRAIGHT SHANK SLIM COLLET & CHUCK SET - LYNDEX STYLE

- Dual contacts of taper and flange.
- Increase spindle contact by 53% over standard holders
- Prevent tools from pulling into spindle.
- Slim design for better clearance.
- Max. Speed: 15,000 RPM



Limited Supply!

MADE IN TAIWAN

RUNOUT ≤ 5 MICRON

Set Includes:

- 1PC of Straight Shank SK10 Holder (Shank: 20mm x100mm Length)
- 8PC of SK10 Collets: 3,4,5,6,7,8,9,&10mm
- 1PC of Wrench
- Fitted Case

10PC SET (M3~M10)

3901-5583

\$54582 (F)



CAT40 SK SLIM COLLET CHUCKS - LYNDEX STYLE

- Dual contacts of taper and flange.
- Increase spindle contact by 53% over standard holders.
- Prevent tools from pulling into spindle.
- Balanced to 20,000 RPM.



Limited Supply!

CAT40 (Drawbar End 5/8" ~11)

RUNOUT ≤ 5 MICRON

Item#	Collet Series	Collet Range	H	C	Gage Depth L (mm)	Price (F)
3901-5504	SK10	0.069~0.393"	1.181~1.969"	1.083"	90	131.38
3901-5506	SK10	0.069~0.393"	1.181~1.969"	1.083"	120	148.50
3901-5523	SK16	0.108~0.630"	1.772~2.756"	1.575"	90	131.38
3901-5525	SK16	0.108~0.630"	1.772~2.756"	1.575"	120	148.50

SK10 & SK16 SK SLIM CHUCK COLLETS - LYNDEX STYLE

- Vacuum quenching heat treatment to hardness HRC46~50.
- Collet front cone convex platform design reduces the entry of dust and chips increasing longer service life.
- The SK slim collet system features an 8° taper angle versus the 16° taper for ER type collets.
- The SK collet results in greater gripping forces. Note! This results in less range capacity for each collet.
- SK collets sit deeper in the tool holder compared to TG and ER type collet systems. This extra length results in higher accuracy and rigidity.

RUNOUT ≤ 5 MICRON



3901-5401 Shown



3901-5456 Shown

SK10

Item#	Size D	Collapse Range	Price (F)
3901-5401	1/8	0.115~0.125"	32.89
3901-5404	3/16	0.168~0.188"	33.13
3901-5407	1/4	0.230~0.250"	33.13
3901-5410	5-16	0.293~0.313"	33.13
3901-5414	3/8	0.355~0.375"	33.13

SK16

Item#	Size D	Collapse Range	Price (F)
3901-5431	1/8	0.112~0.125"	33.13
3901-5435	3/16	0.168~0.188"	33.13
3901-5439	1/4	0.230~0.250"	34.16
3901-5444	5-16	0.293~0.313"	33.13
3901-5448	3/8	0.355~0.375"	32.89
3901-5452	7/16	0.419~0.438"	33.13
3901-5456	1/2	0.480~0.500"	33.13
3901-5460	9/16	0.543~0.562"	33.13
3901-5464	5/8	0.605~0.625"	33.13

Collet Dimensions

Series	d	(mm) d1	d2	L
SK10	15.45	12.0	9.50	30.5
SK16	24.52	18.8	15.5	45.0

KEYLESS DRILL CHUCKS

PRECISION KEYLESS DRILL CHUCKS WITH INTEGRAL SHANKS

- Integrated design maximizes rigidity & accuracy.
- Integral shank is more compact than a combined drill chuck and arbor and eliminates the chuck slipping on its arbor.



T.I.R. \leq .0025"

Item#	Clamping Capacity	Shank	Price (F)
3701-1501	0~1/2"	R8	120.58
3701-1626	1/64~5/8"	R8	135.36
3701-2490	1/64~5/16"	MT2	88.85
3701-2499	1/64~1/2"	MT3	113.38
3701-2502	1/64~1/2"	MT4	103.93
3701-2624	1/64~5/8"	MT3	127.78
3701-2627	1/64~5/8"	MT4	117.13
3701-3503*	1/64~1/2"	BT40	172.44
3701-3628*	1/64~5/8"	BT40	181.50
3701-3001	0~1/2"	NMTB #30	201.22
3701-3011	0~1/2"	NMTB #40	217.20
3701-3015	1/64~5/8"	NMTB #40	233.16

*Limited Supply

Pro-Series ULTRA PRECISION KEYLESS DRILL CHUCKS WITH INTEGRAL SHANKS

- Integrated design maximizes rigidity & accuracy.
- Keyless, self tightening design.
- Integral shank is more compact than a combined drill chuck and arbor and eliminates the chuck slipping on its arbor.

MADE IN TAIWAN



Max. T.I.R. \leq .002"

Item#	Clamping Capacity	Shank	Price (F)
3701-0500	1/64~1/2"	CAT40	240.15
3701-0625	1/8~5/8"	CAT40	256.59
3701-1050	1/64~1/2"	BT30	240.15
3701-1054	0~1/2"	BT40	207.45
3701-1062	1/8~5/8"	BT40	238.78
3701-1500	0~1/2"	R8	215.53
3701-1625	1/8~5/8"	R8	232.03
3701-2500	0~1/2"	MT3	163.53
3701-2501	0~1/2"	MT4	174.35
3701-2625	1/8~5/8"	MT3	174.35
3701-2626	1/8~5/8"	MT4	182.67
3701-3500	0~1/2"	#40NMTB	231.87
3701-3625	1/8~5/8"	#40NMTB	256.59

Pro-Series BT40 HI-TORQUE INTEGRATED KEYLESS DRILL CHUCKS

- Reinforce torque design to increase more clamping power.
- Integrated design maximizes rigidity & accuracy
- Right turn and left turn allowable.
- Maximum T.I.R. does not exceed .002".
- Max. speed 6000 RPM.
- Supplied with wrench.

Limited Supply!

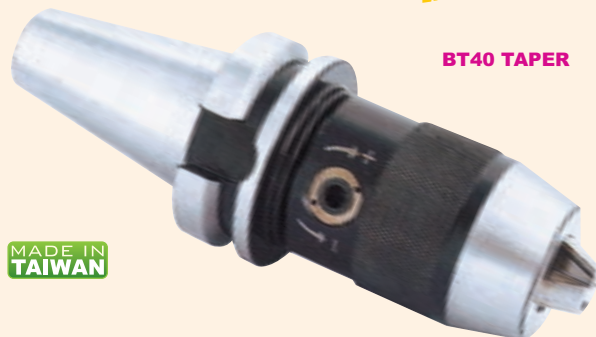

BT40 TAPER

MADE IN TAIWAN

Item#	Clamping Range	Price (F)
3701-2650	.02~1/2"	238.85
3701-2662	.12~5/8"	249.70

BT40 ULTRA PRECISION INTEGRAL DRILL CHUCKS - HEX-KEY LOCKING

- Manufactured and tested at a world class factory that produces highest quality European brands (Babel).
- Suitable for CNC and high precision machine applications.
- High precision and concentricity.
- Right and left rotation.
- High gripping force with effortless tool clamping.
- Short and sturdy design: tool shank and chuck form one unit.
- Simple operation: Quick tool change inside or outside of machine, no unintentional opening in case of sudden spindle stop or change of direction.
- Tightening wrench included.
- Runout test of drill chucks is done with a torque of approx 12 Nm using the following test mandrels:
1/2": 6 mm, 8 mm, 12 mm
5/8": 6 mm, 8 mm, 12 mm und 16 mm



T.I.R. $<$ 0.0012"

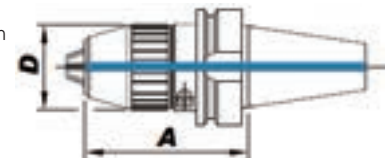

BT40 Shank

Item#	Capacity	A	D	Price (F)
3701-4650	1/2"	3.50"	1.77"	551.57
3701-4652	5/8"	3.74"	1.97"	612.87

SENSITIVE HAND DRILL FEED & SET

- 1/2" diameter hardened and precision ground straight shank x OJT.
- Grasp free turning ring and feed drill.
- Spring loaded 3/4" travel fits any drill, mill, lathe or jig borer.
- Reduces small drill breakage.
- Suitable for drills (.008-5/32")
- TIR: .002"

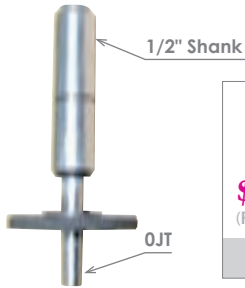

NEW
Drill Feed & Drill Chuck Combo
3700-5000
\$169.98
 (F)

Include: Drill Feed JTO (3700-0001)
 1/8" Keyless Drill Chuck (3700-0002)



Drill Feed, JTO
3700-0001
\$74.40
 (F)

1/8" JTO KEYLESS DRILL CHUCK

- Precision made with highest T.I.R.
- Ultra smooth bearings.

0~1/8"/0~3MM
3700-0002
\$115.78
 (F)



Pro-Series STRAIGHT SHANK INTEGRATED KEYLESS DRILL CHUCKS

- Integrated design maximizes rigidity & accuracy
- Supplied with wrench.

T.I.R. < .0002"



SUPERIOR FINISH

Item#	Clamping Range	Shank Dimension	Price (F)
3701-4500	1/64~1/2"	5/8x2.4"	111.25
3701-4502	1/64~1/2"	3/4x3.2"	111.25
3701-4625	1/64~5/8"	5/8x2.4"	122.23
3701-4627	1/64~5/8"	3/4x3.2"	122.23

HEAVY DUTY KEYLESS DRILL CHUCKS

- Self-tightening design.
- No chuck key required.
- Hardened tool steel to insure accuracy and extended chuck life.
- Can be used on a wide variety of machinery.
- Solid steel body.

TAPER MOUNTED

0~1/2", JT33
3700-0210
\$463.1
 (E)



Item#	Capacity	Taper Mount	Price (E)
3700-0204	0~3/8"	JT2	38.44
3700-0207	0~3/8"	JT33	38.44
3700-0210	1/32~1/2"	JT33	46.31
3700-0212	1/32~1/2"	JT2	46.31
3700-0213	1/32~1/2"	JT6	46.31
3700-0215	1/8~5/8"	JT6	52.32

ULTRA PRECISION KEYLESS DRILL CHUCKS

- Super heavy duty ultra precision.
- Closer tolerances assure excellent runout accuracy.
- Normal gripping power when hand tightened and double the torque when used with spanner wrench.
- Especially suitable for CNC machines.

HiP PRO-SERIES

TAPER MOUNTED

0~1/2", JT33
3700-0255
\$615.6
 (E)



Item#	Capacity (Inch)	Accuracy (Inch)	Taper Mount	Body Dia.	Price (E)
3700-0250	1/32~3/8	.0024	JT2	1.65"	48.26
3700-0251	1/32~3/8	.0024	JT33	1.65"	48.26
3700-0255	1/32~1/2	.0024	JT33	1.89"	61.56
3700-0257	1/32~1/2	.0024	JT6	1.89"	67.72
3700-0259	1/32~5/8	.0028	JT6	2.09"	76.12

WRENCHES FOR KEYLESS DRILL CHUCKS

Hook wrench for keyless drill chucks



Item#	Fit Chuck Size	Taper Mount	Price (E)
3700-0291	0~5/16"	JT1	6.99
3700-0292	0~3/8"	JT2, JT33	7.22
3700-0293	0~1/2"	JT33, JT6	7.22
3700-0294	1/8~5/8"	JT3, JT6	7.22

DRILL CHUCKS

BUDGET DRILL CHUCKS

- Accuracy and strong gripping force.
- For portable, bench or floor type drill press.
- Supplied with chuck key.

TAPER MOUNTED

Item#	Capacity	Taper Mount	Price (F)
3700-0100	1/32~3/8"	JT2	19.55
3700-0102	1/32~1/2"	JT33	21.55
3700-0103	1/32~1/2"	JT6	21.55
3700-0105	1/8~5/8"	JT3	23.97
3700-0106	1/32~5/8"	JT33	23.97
3700-0108	3/16~3/4"	JT3	39.52



1/2", JT33
3700-0102
\$21.55 (F)

BALL BEARING DRILL CHUCKS

- Extra heavy duty.
- Anti-thrust ball bearing to increase the grip power with high speed drilling.
- All parts hardened and precision ground.
- Ultra smooth with ball bearing.
- Supplied with chuck key.



RUNOUT: < .0032"

Item#	Capacity	Taper Mount	Price (F)
3700-1091	1/32~3/8"	JT2	57.48
3700-1092	1/32~1/2"	JT6	57.68
3700-1093	1/32~1/2"	JT33	59.23
3700-1094	1/32~1/2"	JT3	60.36
3700-1095	1/32~5/8"	JT3	68.68
3700-1097	1/32~3/4"	JT4	153.94

Pro-Series DRILL CHUCKS - With Key

- Precision made with the highest T.I.R.
- For heavy duty jobs.
- Supplied with chuck key.

RUNOUT: .005"
TAPER MOUNTED



Item#	Capacity	Taper Mount	Price (F)
3700-0081	1/32~3/8"	JT2	35.65
3700-0083	1/32~1/2"	JT33	30.89
3700-0084	1/32~1/2"	JT6	32.67
3700-0085	1/8~5/8"	JT3	43.03
3700-0086	1/8~5/8"	JT33	51.31
3700-0087	1/8~5/8"	JT6	43.03
3700-0089	3/16~3/4"	JT3	64.48

STAINLESS STEEL DRILL CHUCKS - With Key

- Made of stainless steel (Anti-Rust).
- Acid resistance.
- Recommended for EDM machines and the food & marine industries.



Item#	Capacity	Taper Mount	Key Size	Price (F)
3700-0301	1/64~5/32"	JT0	T0-3S	77.13
3700-0302	1/64~1/4"	JT1	T1-3S	85.36
3700-0309	1/64~3/8"	JT2S	T2-3S	77.50
3700-3001*	1/64~3/8"	JT2	T2-3S	62.00

* Limited Supply

Pro-Series PRECISION DRILL CHUCKS - With Key

- Super precision durable with strong body.
- The nut and jaws are AISI-52100 (bearing steel) and heat treated.
- The taper is precision ground for improved precision.
- Accuracy: 0.0032".
- Supplied with chuck key.

MADE IN TAIWAN

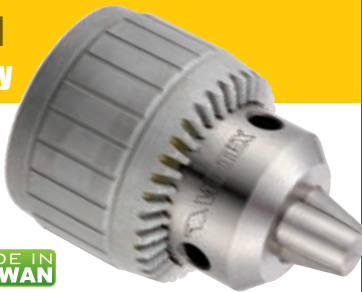

Item#	Capacity	Taper Mount	Price (F)
3701-0100	1/64~1/4"	JT1	36.19
3701-0108	1/64~1/2"	JT33	46.52
3701-0110	1/64~1/2"	JT6	46.52
3701-0115	1/32~5/8"	JT3	61.16
3701-0120	1/8~3/4"	JT4	108.55

REPLACEMENT KEY



Item#	Key Size	Price (F)
3700-0311	T0-3S	20.68
3700-0312	T1-3S	16.23
3700-0313	T2-3S	18.37

Pro-Series REPLACEMENT DRILL CHUCK KEYS

- For key type drill.
- Measure the chucks diameter of the pilot hole/shank(D) to match drill chuck.

MADE IN TAIWAN



Item#	Type	(mm) D	(mm) L	Price (F)
3070-0041	T1	3.2	35	3.11
3070-0042	T2	4	42	3.11
3070-0045	T4	6	45	3.11
3070-0047	T5	6.5	45	3.11
3070-0049	T7	8	50	3.54
3070-0057	T8	9.5	65	5.25
3070-0059	T9	11	100	23.00

4-IN-1 MASTER DRILL CHUCK KEYS

- Convenient one-key can open different chucks.
- Fits most popular chucks.

3070-0048
\$398 (F)

For SIZE: K1,K2,K3,K4

3070-0481
\$946 (F)

For SIZE: K5,K6,K7,K8



DRILL CHUCK ARBORS

3PC PIN CHUCK SET

- Holds small drills firmly.
- Ensures complete collet length.
- Overall length: 2-1/2"
- Shank size: 1/4"

Includes:
3 Collets - capacity: 0 - 1/32",
1/32 - 1/16", 1/16 - 3/32"



3700-0501
\$11.10
(F)

4PC PIN VISE SET

- Hollow handle for long wire or rods.



Includes:
Ranges: 0-.055", .025-.075",
.045-.125", .110-.187"

3700-0505
\$15.35
(F)

MT TO JT REVOLVING TAILSTOCK ARBORS/ADAPTERS

- Use to support small diameter work where a live center is not practical.
- This is a "live" adapter with smooth, sealed bearings for the tailstock.
- Use it to mate with any Jacob Taper (JT) taper drill chuck.
- The shank is Morse taper (MT).



MT2 x JT2
3906-4922
\$41.57
(F)

MT TO JT



* Drill Chuck Not Included

Item#	Taper	Drawbar Thread	Sale (F)
3906-4922	MT 2 x JT2	M10	41.57
3906-4925	MT2 x JT3	M10	41.56
3906-4928	MT3 x JT2	M12	41.56
3906-4932	MT3 x JT3	M12	41.56

DRILL CHUCK ARBORS



Hardened & Ground



Straight TO JT

Item#	Arbor Taper to Chuck	Price (F)	Item#	Arbor Taper to Chuck	Price (F)
3700-0111	MT1 to JT0	8.48	3700-0162	1/2" to JT0	9.25
3700-0112	MT1 to JT1	8.49	3700-0163	1/2" to JT1	9.25
3700-0113	MT1 to JT33	8.49	3700-0164	1/2" to JT2	9.25
3700-0115	MT2 to JT1	8.34	3700-0178	1/2" to JT3	8.63
3700-0151	MT2 to JT2	11.12	3700-0165	1/2" to JT6	9.25
3700-0149	MT2 to JT3	11.33	3700-0170	1/2" to JT33	8.69
3700-0117	MT2 to JT4	8.49	3700-0166	5/8" to JT2	10.07
3700-0150	MT2 to JT6	11.12	3700-0171	5/8" to JT33	11.56
3700-0152	MT2 to JT33	11.12	3700-0167	3/4" to JT2	10.07
3700-0153	MT3 to JT33	12.11	3700-0168	3/4" to JT3	10.07
3700-0154	MT3 to JT2	15.31	3700-0172	3/4" to JT33	11.06
3700-0155	MT3 to JT3	12.11	3700-0180	3/4" to JT4	11.90
3700-0159	MT3 to JT4	11.63	3700-0181	3/4" to JT6	11.90
3700-0156	MT3 to JT6	12.11	3700-0185	5/8" to JT1	11.90
3700-0160	MT4 to JT3	16.20	3700-0187	5/8" to JT3	11.90
3700-0161	MT4 to JT4	16.20	3700-0189	5/8" to JT6	11.90
3700-0157	MT4 to JT33	15.20	3700-1721	7/8" to JT33	11.69
3700-0120	MT4 to JT5	16.20	3700-0191	1" to JT2	17.33
3700-0158	MT4 to JT6	16.17	3700-0174	1" to JT33	18.09
3700-0123	MT5 to JT3	28.16	3700-0193	1" to JT4	17.31
3700-0124	MT5 to JT4	29.38	3700-0173	1-1/4" to JT33	17.29
			3700-0175	1-1/2" to JT33	20.24
			3700-0176	1-3/4" to JT33	18.87

R8 DRILL CHUCK ARBORS

- Hardened and ground.

for Bridgeport® type mills



R8 TO JT

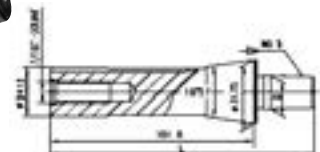

DRAWBAR END THREAD: 7/16" -20

Item#	Arbor Taper to Chuck	D (mm)	L (mm)	Price (F)
3700-0135	R8 to JT2	14.199	128	16.20
3700-0138	R8 to JT3	20.599	137	16.20
3700-0131	R8 to JT33	15.85	132	16.20
3700-0139	R8 to JT4	28.55	148	16.20
3700-0140	R8 to JT6	17.17	132	16.20

CHUCK WEDGE SETS



Item#	JT #	Price (F)
3700-0401	2	11.78
3700-0402	3	11.78
3700-0405	6&33	11.78

- For removing taper mount chucks from arbors or spindles.
- 2pc per set.

MACHINE TOOL ACCESSORIES

DRILL CHUCK ARBORS

MORSE TAPER (MT) SLEEVES



- Used to convert spindles to larger or smaller tapers and extend the spindles of drill presses, radial drills, boring mills and turret lathes.

INDIVIDUALS

Item#	Inside Taper	Outside Taper	Price (F)
3900-1843	MT1	MT2	8.33
3900-1841	MT1	MT3	12.24
3900-1842	MT2	MT3	12.24
3900-1844	MT2	MT4	13.28
3900-1848	MT3	MT4	13.78
3900-1849	MT3	MT5	24.44
3900-1853	MT4	MT5	26.93
3900-1856	MT5	MT6	49.71

4 PC SET
3900-1850
\$46.58
(F)

MT1-MT2, MT2-MT3, MT3-MT4, MT4-MT5

NMTB 30 & 40 TAPER TO JACOBS ARBORS



Drawbar End: #30- 1/2"~13
#40- 5/8"~11

Jacob Taper	Taper 30 Item#	Price (F)	Taper 40 Item#	Price (F)
JT2	3900-1762	40.12	3900-1772	49.50
JT3	3900-1763	40.87	3900-1773	46.80
JT33	3900-1764	43.25	3900-1774	46.80
JT6	3900-1766	43.25	3900-1776	46.80

MORSE TAPER EXTENSION SOCKETS

- For adapting tools with Morse taper shanks to machines having smaller, same or larger Morse taper spindle.

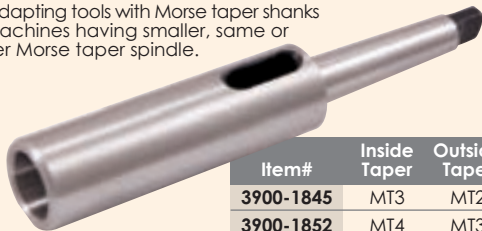

Item#	Inside Taper	Outside Taper	Price (F)
3900-1845	MT3	MT2	29.63
3900-1852	MT4	MT3	48.97
3900-1872	MT5	MT4	73.41

CAT 40 "V" FLANGE DRILL CHUCK ARBORS

- For CNC machines having CAT 40 taper spindles
- Hardened and precision ground
- Gage depth: 1.772"



RETENTION KNOB THREAD: 5/8" -11

Item#	CAT Taper#	Jacobs Taper	Price (F)
3900-4205	40	JT33	68.12
3900-4207	40	JT6	70.12
3900-4208	40	JT4	70.12
3900-4209	40	JT3	70.12
3900-4206	40	JT2	70.12

DRIFT/CENTER KEYS



- Fully drop-forged
- Used for knocking taper shank drills, reamers, etc. out of Morse taper sleeves.

INDIVIDUALS

Item#	Size for	Price (F)
3900-0261	MT1	2.92
3900-0262	MT2	3.49
3900-0263	MT3	5.49
3900-0264	MT4,5,6	7.01

4 PC SET
3900-0265
\$17.10
(F)

Pro-Series DAYTON STYLE HAND DRIFT TOOL

- Forged and hardened, high rigid tools.
- Used to remove taper shank tools from machinery spindles, sleeves, and extension sockets.
- Morse Taper Drift Range: MT2 ~ MT5

15" LONG



Range MT2-MT5
3900-0267
\$56.50
(F)

MADE IN TAIWAN

BT 30 & 40 TO JT DRILL CHUCK ARBORS

- For CNC machines having BT taper spindles.
- Concentricity .0002".
- All critical surfaces are hardened and precision ground.



Item#	BT Taper	Jacobs Taper	Gage Depth (Inch)	OAL (Inch)	Price (F)
3900-4194	30	2	1.77	4.6	54.06
3900-4195	30	3	1.77	4.9	53.54
3900-4196	30	4	1.77	5.3	53.54
3900-4197	30	6	1.77	3.7	37.44
3900-4198	30	33	1.77	3.7	59.72
3900-4199	40	2	1.77	5.2	59.72
3900-4200	40	3	1.77	5.6	59.72
3900-4201	40	4	1.77	6.0	59.72
3900-4202	40	6	1.77	5.4	59.72
3900-4203	40	33	1.77	5.4	56.50

BORING & FACING HEAD SET

VERTEX R8 3 Inch UNIVERSAL BORING & FACING HEAD SET

• Main part of the universal boring head is the body (1), in which the tool slide (3) moves on dovetail guideways. The tool slide is provided with holes for accommodation of tools and tool holders (4). In boring holes or turning external cylindrical surfaces, the tool is adjusted with the aid of the graduated dial for fine setting of tool slide (5), one division of which means a change in diameter of bored hole by .0005". On the types rapid adjustment of the tool slide (3) can be produced by rotating the graduated dial for quick adjustment of the tool slide (2). During recessing, turning of front or rear facings or similar jobs calling for automatic transverse feed movement to the tool slide, the preselected feed movement to the tool slide is engaged with the aid of the engagement ring (6). After setting of tool, the automatic transverse feed movement to the tool slide is started by braking to the brake ring (7), by means of the handle (8). The clutch (9) provides for tripping of the automatic feed movement when cutting resistance increases or when the trip dog is approached. Mechanism of the boring heads has a lubrication circuit delivering oil from two lubricators to all friction surfaces. All parts are hardened and working surfaces are ground.



HHP PRO-SERIES

GRADUATION: 0.01MM

Boring Range: 5~250mm Dia.

1001-6008

\$1,503¹³

MADE IN TAIWAN

• Set Includes:

- 1 - Boring Head
- 1 - R8 Shank
- 4 - Carbide Tipped Boring Bars
- 1 - BP-21 Adapter
- 2 - Adapter (Hold 1/4" Square Tool Bit)
- 2 - Clamping Sleeve
- 1 - Stop Rod
- 1 - HSS 1/4" Square Tool Bit
- 3 - Allen Wrenches
- 1 - Fitted Carry Case



SPECIFICATION (mm)

Actual Size	Overing Bar Hole Size	Boring Bar Hole Size	Center Dist. Between Holes	Cross Hole Dia.	Offset
78	100	18	23	18	15



Clamping Sleeve		Boring Bar	
Material	Part No.	Material	Part No.
Aluminum	BP-1	Aluminum	BP-1
Aluminum	BP-2	Aluminum	BP-2
Aluminum	BP-3	Aluminum	BP-3
Aluminum	BP-4	Aluminum	BP-4
Aluminum	BP-5	Aluminum	BP-5
Aluminum	BP-6	Aluminum	BP-6
Aluminum	BP-7	Aluminum	BP-7
Aluminum	BP-8	Aluminum	BP-8
Aluminum	BP-9	Aluminum	BP-9
Aluminum	BP-10	Aluminum	BP-10
Aluminum	BP-11	Aluminum	BP-11
Aluminum	BP-12	Aluminum	BP-12
Aluminum	BP-13	Aluminum	BP-13
Aluminum	BP-14	Aluminum	BP-14
Aluminum	BP-15	Aluminum	BP-15
Aluminum	BP-16	Aluminum	BP-16
Aluminum	BP-17	Aluminum	BP-17
Aluminum	BP-18	Aluminum	BP-18
Aluminum	BP-19	Aluminum	BP-19
Aluminum	BP-20	Aluminum	BP-20
Aluminum	BP-21	Aluminum	BP-21
Aluminum	BP-22	Aluminum	BP-22
Aluminum	BP-23	Aluminum	BP-23
Aluminum	BP-24	Aluminum	BP-24
Aluminum	BP-25	Aluminum	BP-25
Aluminum	BP-26	Aluminum	BP-26
Aluminum	BP-27	Aluminum	BP-27
Aluminum	BP-28	Aluminum	BP-28
Aluminum	BP-29	Aluminum	BP-29
Aluminum	BP-30	Aluminum	BP-30
Aluminum	BP-31	Aluminum	BP-31
Aluminum	BP-32	Aluminum	BP-32
Aluminum	BP-33	Aluminum	BP-33
Aluminum	BP-34	Aluminum	BP-34
Aluminum	BP-35	Aluminum	BP-35
Aluminum	BP-36	Aluminum	BP-36
Aluminum	BP-37	Aluminum	BP-37
Aluminum	BP-38	Aluminum	BP-38
Aluminum	BP-39	Aluminum	BP-39
Aluminum	BP-40	Aluminum	BP-40
Aluminum	BP-41	Aluminum	BP-41
Aluminum	BP-42	Aluminum	BP-42
Aluminum	BP-43	Aluminum	BP-43
Aluminum	BP-44	Aluminum	BP-44
Aluminum	BP-45	Aluminum	BP-45
Aluminum	BP-46	Aluminum	BP-46
Aluminum	BP-47	Aluminum	BP-47
Aluminum	BP-48	Aluminum	BP-48
Aluminum	BP-49	Aluminum	BP-49
Aluminum	BP-50	Aluminum	BP-50

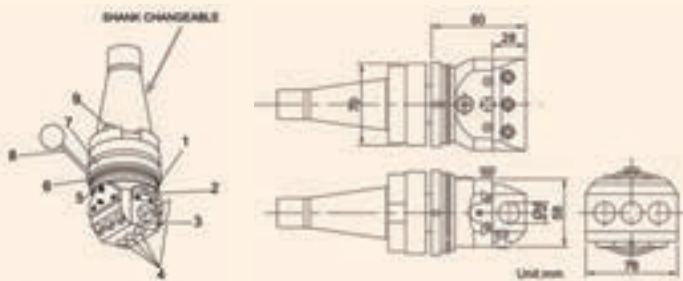

MACHINE TOOL ACCESSORIES

BORING HEADS & SHANKS

BORING HEAD SETS

- BORING HEAD: Bar holder moves freely and smoothly. Design assures superior rigidity for chatter-free boring and precise hole size accuracy. Hardened and ground adjusting screw designed for long lasting and trouble free use.

KIT INCLUDES:

BORING HEAD, SHANK, C6 CARBIDE TIPPED BORING BAR SET



Item#	Head Size	Shank Taper	Shank To Head	Boring Bar	Tool Capacity	Price (E)
1001-0105	2"	3MT	7/8"~20	1/2"/9pc	Up to 1/2"	127.71
1001-0106	2"	R8	7/8"~20	1/2"/9pc	Up to 1/2"	132.00
1001-0107	3"	R8	1-1/2"~18	3/4"/12pc	Up to 3/4"	180.03

BORING HEADS

- Bar holder moves freely and smoothly.
- Design assures superior rigidity for chatter-free boring and precise hole size accuracy.
- Hardened and ground adjusting screw designed for long lasting and trouble free use.
- Threaded back for adapting to boring shank.

ADAPTING THREAD

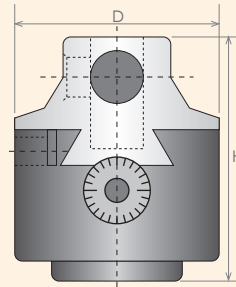

GRADUATION .0005"

Item#	Head Dia. D	Head Ht H	Adapting Threads	Tool Capacity	Max. Offset	Boring Bar Hole Size	Shaft Hole Diameter	Dia of Boring	Price (E)
1001-0101	2"	2-7/16	1-1/2"~18	Up to 1/2"	5/8"	1/2	1/2	3/8~5.0	65.46
1001-1011	2"	2-7/16	7/8"~20	Up to 1/2"	5/8"	1/2	1/2	3/8~5.0	68.76
1001-0102	3"	3-5/32	1-1/2"~18	Up to 3/4"	1"	3/4	3/4	1/2~9.0	94.86
1001-0103	4"	3-1/2	1-1/2"~18	Up to 1"	1-5/8"	1	1	5/8~15.0	222.12

PRECISION BORING HEAD SHANKS

- Use for boring heads.
- Made of high grade tool steel.
- Hardened and ground.



7/8" ~ 20 MOUNTING THREAD

Item#	Taper of Shank	End Type	Price (F)
1001-0090	R8	Draw Bar	33.26
1001-0080	MT2	Draw Bar	29.02
1001-0431	MT3	Draw Bar	34.25
1001-0050	#30NMTB	Draw Bar	30.67
1001-0052	#40NMTB	Draw Bar	50.88
1001-0056	Straight 1/2"		32.54
1001-0058	Straight 3/4"		33.17
1001-0060	Straight 1"		32.54
1001-0062	Straight 1-1/4"		47.21

DRAWBAR END THREAD

- R8- 7/16" -20
- MT2- 3/8" -16
- MT3- 3/8" -16
- MT4- 1/2" -13
- #30- 1/2" -13
- #40- 5/8" -11
- #50- 1"-8

1-1/2" ~ 18 MOUNTING THREAD

Item#	Taper of Shank	End Type	Price (F)
1001-0089	R8	Draw Bar	33.66
1001-0081	MT2	Draw Bar	36.23
1001-0085	MT3	Draw Bar	32.54
1001-0068	#30NMTB	Draw Bar	48.13
1001-0069	#40NMTB	Draw Bar	48.13
1001-0070	#50NMTB	Draw Bar	64.19
1001-0072	Straight 1/2"		36.23
1001-0073	Straight 5/8"		29.02
1001-0074	Straight 3/4"		32.54
1001-0076	Straight 1"		32.54
1001-0077	Straight 1-1/4"		34.29
1001-0078	Straight 1-1/2"		59.58
1001-0079	Straight 2"		64.96
1001-0440	CAT40		54.50

Pro-Series BORING TOOL SETS

- Rugged design allows excellent rigidity for chatter-free boring.
- Head features a threaded back for multiple shanks.
- Set complete with Boring Head, Boring Shank, Carbide Tipped Boring Bar & L-shape Hex Wrenches.
- Dial on head with 0.0005" graduation for accurate hole sizing.
- Fitted durable carry case included.



1001-5937 Shown



1001-5937 Shown

	2" HEAD	3" HEAD
Boring Head Thread	7/8"-20 T.P.I.	1-1/2"-18 T.P.I.
Offset	5/8"	3/4"
Crosshole	1/2"	3/4"
Shank Thread		
(Drawbar End)R8	7/16"-20 UNC	7/16"-20 UNC
(Drawbar End)MT2	3/8"-16 UNC	
(Drawbar End)NT40		5/8"-11 UNC
Mini. Boring Diameter	0.394"	0.394"
Max. Boring Diameter	5.906"	7.874"
Max. Boring Depth	1.970"	3.150"

Item#	Boring Head (Dia.)	Shank	No. of Boring Bars	Boring Bar Hole Size	Price (E)
1001-5935	2"	R8	9	1/2"	255.06
1001-5937	2"	MT2	9	1/2"	242.87
1001-5940	3"	R8	12	3/4"	324.28
1001-5942	3"	NT/NMTB 40	12	3/4"	323.86

Pro-Series BORING HEADS

- Direct reading dial screw.
- Bar holder moves freely and smoothly.
- Design assures superior rigidity for chatter-free boring and precise hole size accuracy.
- Made of high grade alloy steel.
- Threaded back for adapting to boring shank.

ADAPTING THREAD GRADUATION .0005" .001" 0-50 READING

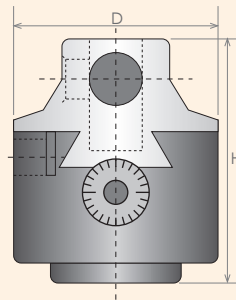

SUPERIOR CRAFTSMANSHIP HARDENED & GROUND

Item#	Head Size, D	Adapting Threads	Tool Capacity	Max. Offset	Head OAL, H	Boring Bar Hole Size	Shaft Hole Diameter	Diameter of Boring	Price (E)
1001-1020	2"	1-1/2"~18	Up to 1/2"	5/8"	2-7/16	1/2	1/2	3/8-5.0	104.76
1001-1021	2"	7/8"~20	Up to 1/2"	5/8"	2-7/16	1/2	1/2	3/8-5.0	101.55
1001-1023	3"	1-1/2"~18	Up to 3/4"	1"	3-5/32	3/4	3/4	1/2-9.0	144.36
1001-1026	4"	1-1/2"~18	Up to 1"	1-5/8"	3-1/2	1	1	5/8-15.0	241.14

Pro-Series BORING SHANKS

- Made of 20CrMnTi alloy steel.
- Electrolysis nickel coating.
- Superior craftsmanship.

DRAWBAR END THREAD

- R8: 7/16" -20
- MT3: 3/8" -16



HARDENED & GROUND



7/8" ~ 20 MOUNTING THREAD

Item#	Taper of Shank	End Type	Price (F)
1001-1090	R8	Draw Bar	42.90
1001-1431	MT3	Draw Bar	41.25

1-1/2" ~ 18 MOUNTING THREAD

Item#	Taper of Shank	End Type	Price (F)
1001-1080	MT3	Draw Bar	41.25
1001-1089	R8	Draw Bar	39.33

BORING HEAD SETS

Pro-Series BORING TOOL SETS

- Wide bearing surface provides super accuracy.
- Rugged design allows excellent rigidity for chatter-free boring.
- Head features a threaded back for multiple shanks exchangeable.

- Set complete with Boring Head, Boring Shank, Boring Bars, Adapters and L-shape Hex Wrenches.
- Dial on head with 0.0005" graduation for accurate hole sizing.
- Fitted durable carry case included.

HHIP
PRO-SERIES

MADE IN
TAIWAN



3800-5935 Shown



Item#	Boring Head (Dia.)	Shank	No. of Boring Bar/Adapter	Boring Bar Hole Size	N.W. (lbs.)	Price (E)
3800-5935	2"	R8	2/1	1/2"	5	356.79
3800-5940	3"	R8	5/3	3/4"	10	582.45
3800-5942	3"	NT/NMTB 40	5/3	3/4"	11	528.75
3800-5943	3"	BT40	5/3	3/4"	11	622.11



3800-5940 Shown

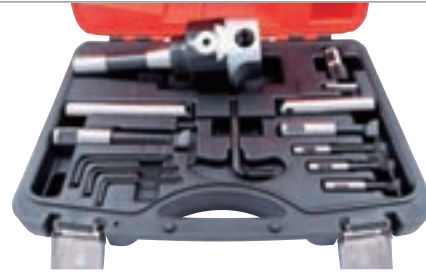

GRADUATION .0005"
READING .0005"/0-100

SPECIFICATIONS

2" HEAD

Boring Head Thread.....	1-1/2"-18 T.P.I.
Offset.....	5/8"
Crosshole.....	1/2"
Shank Thread (Drawbar End) R8.....	7/16"-20 UNC
Mini. Boring Diameter.....	0.394"
Max. Boring Diameter.....	5.906"
Max. Boring Depth.....	1.970"
Boring Bars Size.....	1/2"
Adapter 1 (Hold 3/8" Boring Bar).....	None
Adapter 2 (Hold 1/4"x1.2" Square Tool Bit).....	Ø1/2"xØ3/4"x3.5"
Adapter 3 (Hold 1/4"x1.2" Square Tool Bit).....	None
Adapter 4 (Hold 1/4"x1.2" Square Tool Bit).....	None

3" HEAD

Boring Head Thread.....	1-1/2"-18 T.P.I.
Offset.....	3/4"
Crosshole.....	3/4"
Shank Thread (Drawbar End): R8.....	7/16"-20 UNC
NT 40.....	5/8"-11 UNC
BT40.....	M16x2.0
Mini. Boring Diameter.....	0.394"
Max. Boring Diameter.....	7.874"
Max. Boring Depth.....	3.150"
Boring Bars Size.....	3/8" & 3/4"
Adapter 1 (Hold 3/8" Boring Bar).....	Ø3/4" x Ø3/8" x 2"
Adapter 2 (Hold 1/4"x1.2" Square Tool Bit).....	None
Adapter 3 (Hold 1/4"x1.2" Square Tool Bit).....	Ø3/4" x 3.5"
Adapter 4 (Hold 1/4"x1.2" Square Tool Bit).....	Ø3/4" x 4.7"



3800-5942 Shown



3800-5943 Shown

R8 BORING TOOL SETS -WITH INDEXABLE BORING BARS

- Indexable boring bars take TC_21.5 C6 carbide inserts (included).
- Head features a threaded back for multiple shanks exchangeable.
- Set complete with Boring Head, Boring Shank, Indexable Boring Bars, Torx & L-shape Hex Wrenches.
- Fitted carry case included.
- A micrometer lead screw provides 0.001" direct reading accuracy and ease of adjusting.
- 1 DIV = 0.001 meaning **on the 0-50 dial**, when turning the dial by 1 division/graduation, the boring head's travel is 0.001" in radius movement, 0.002" in diameter movement; **on the 0-100 dial**, when turning the dial by 1 division/graduation, the boring head's travel is 0.0005" in radius movement, 0.001" in diameter movement.

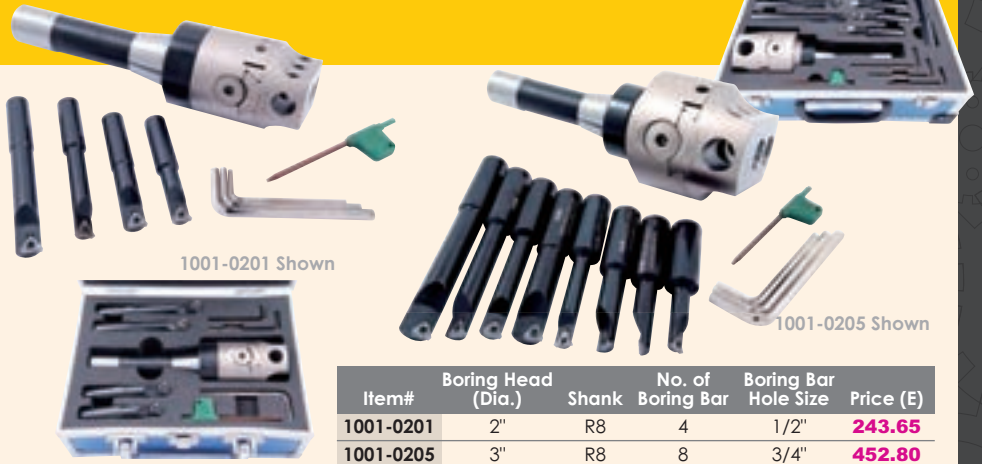

Item#	Boring Head (Dia.)	Shank	No. of Boring Bar	Boring Bar Hole Size	Price (E)
1001-0201	2"	R8	4	1/2"	243.65
1001-0205	3"	R8	8	3/4"	452.80

BORING BAR SET INCLUDED

Set	Shank	Min. Bore	(Inch) OAL	Bore Depth	Use Insert	Use Torx Wr.	Use Screw	Item #	Price (F)
4	1/2	7/16	2-3/4	1-1/4	TCMT21-51	T-8	M2.5x5.0	1001-0704	117.79
		7/16	3-5/8	2-1/8					
		1/2	3	1-1/2					
		1/2	4	2-1/2					
8	3/4	7/16	3-3/8	1-3/8	TCMT21-51	T-8	M2.5x5.0	1001-0708	291.48
		7/16	4-1/4	2-1/4					
		1/2	3-5/8	1-5/8					
		1/2	4-5/8	2-5/8					
		9/16	3-7/8	1-7/8					
		9/16	5	3					
		11/16	4-1/4	2-1/4					
		11/16	5-1/2	3-1/2					

C6 GRADE: carbide for steel and alloy steel

	2" HEAD	3" HEAD
Graduations	0.001"/0-50	0.0005"/0-100
Boring Head Thread	1-1/2"-18 T.P.I.	1-1/2"-18 T.P.I.
Offset	5/8"	1"
Crosshole	1/2"	3/4"
Shank Thread (Drawbar End)	7/16"-20 UNC	7/16"-20 UNC
Mini. Boring Diameter	0.394"	0.394"
Max. Boring Diameter	5.906"	7.874"
Max. Boring Depth	1.970"	3.150"

Pro-Series OFFSET BORING TOOL SETS

- Rugged construction for smooth and chatter-free boring.
- Heat treated parts made from SCM steel.
- Feeding quantity cutting will proceed 0.0008" at every scale of 0.0004".
- Set complete with Boring Head, Boring Shank, Boring Bars, Adapters and L-shape Hex Wrenches.
- Dial on head with 0.0005" graduation for accurate hole sizing.
- Fitted durable carry case included.

OPTIONAL NT40 SHANK

3800-5951

\$8875 (E)



OPTIONAL R8 SHANK

3800-5950

\$8249 (E)



SPECIFICATION

Boring Head Shank Hole.....	M36
Offset.....	1.1"
Crosshole.....	3/4"
Shank Thread (Drawbar End):	
R8.....	7/16"-20 UNC
NT 40.....	5/8"-11 UNC
Mini. Boring Diameter.....	0.197"
Max. Boring Diameter.....	9.840"
Max. Boring Depth.....	3.540"
Boring Bars Size.....	3/8" & 3/4"
Adapter 1 (Hold 3/8" Boring Bar).....	Ø3/4" x Ø3/8" x 2"
Adapter 2 (Hold 1/4"x1.2" Square Tool Bit).....	Ø3/4" x 3.5"
Adapter 3 (Hold 1/4"x1.2" Square Tool Bit).....	Ø3/4" x 4.7"



MADE IN TAIWAN

HHIP PRO-SERIES

Item#	Boring Head (Dia.)	Included Shank	No. of Boring Bar/Adapter	Boring Bar Hole Size	N.W. (lbs.)	Price (E)
3800-5945	3.3"	R8	5/3	3/4"	11	735.55
3800-5947	3.3"	NT/NMTB 40	5/3	3/4"	12	742.60

3800-5945 Shown

CLAMPING KITS

Pro-Series 58PC STEEL CLAMPING KITS

- Fits milling machines, tables & machines with T-slots.
- Made of powdered casting steel for stronger strength.
- All parts heat treated.
- Plastic rack included.



SET 3900-0001 Shown

Item#	Table Slot	Stud Size	Price (F)
3900-2110	3/8"	5/16"~18	75.63
3900-0002	1/2"	3/8"~16	76.83
3900-2112	7/16"	3/8"~16	76.13
3900-0001*	5/8"	1/2"~13	86.29
3900-0003	3/4"	5/8"~11	145.86

5/8" T-Slot
3900-0001
\$ **86.29**
(F)



* T-SLOT CLEANER & WRENCH INCLUDED

Each Kit Contains						
24	4	6	6	6	12	1
Studs 4 of ea. 3", 4", 5", 6", 7", 8" long	Coupling units	Flange nuts	Forged steel step clamps 2 ea. based on stud sets	T-Nuts	Steel step blocks	Wall rack

Ultra Quality 58PC STEEL CLAMPING KITS

- Manufactured at world class factory that produces highest quality US brands.
- Made of IC45e steel for stronger strength.
- All parts are case hardend or heat treated to HRC30~40.

Item#	Table Slot	Stud Size	Price (F)
3901-0002	7/16"	3/8"~16	120.00
3901-0006	5/8"	1/2"~13	142.07

Each Kit Contains						
24	4	6	6	6	12	1
Studs 4 of ea. 3", 4", 5", 6", 7", 8" long	Coupling units	Flange nuts	Forged steel step clamps 2 ea. based on stud sets	T-Nuts	Steel step blocks	Wall rack



Ultra Quality 5PC STEEL CLAMPING SETS

- Manufactured at world class factory that produces highest quality US bands.
- Made of IC45e steel for stronger strength.
- All parts are case hardend or heat treated to HRC30~40.

EACH KIT CONTAINS: Step Clamp, Step Block, Stud, T-slot Nut & Flange Nut.

Item#	Table Slot	Stud Size	(Inch) Clamp Length	Clamp Height	Price (F)
3901-0301	3/8	5/16~18	4	3	14.64
3901-0302	7/16	3/8~16	4	3	15.73
3901-0304	0.54	1/2~13	6	3	18.75
3901-0307	5/8	1/2~13	6	3	21.79
3901-0311*	11/16	5/8~11	6	4.5	27.87
3901-0314*	3/4	5/8~11	6	4.5	33.41

*Limited Supply



Pro-Series 58PC METRIC STEEL CLAMPING KITS

- Fits milling machines, tables & machines with T-slots.
- Made of powdered casting steel for stronger strength.
- All parts heat treated.
- Plastic rack included.

Item#	Table Slot	Stud Size	Price (E)
3901-0008	10mm	M8x1.25P	162.99
3901-0010	12mm	M10x1.5P	162.99
3901-0012	14mm	M12x1.75P	174.08

MADE IN TAIWAN

Each Kit Contains						
24	4	6	6	6	12	1
Studs 4 of ea. 3", 4", 5", 6", 7", 8" long	Coupling units	Flange nuts	Forged steel step clamps 2 ea. based on stud sets	T-Nuts	Steel step blocks	Wall rack



3901-0012 Shown

NEW

INCH CLAMPING STUDS

- Made of alloy steel and heat treated.
- Black oxide finish.

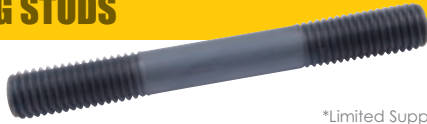

*Limited Supply

Item#	Stud Thread	Overall Length	Price(F)	Item#	Stud Thread	Overall Length	Price(F)
3421-3984	1/4~20	2	1.70	3436-3649	5/8~11	6	6.90
3421-4008	1/4~20	3	1.90	3436-3656	5/8~11	7	7.10
3421-4024	1/4~20	4	2.01	3436-3664	5/8~11	8	8.61
3436-3250	5/16~18	2	2.21	3436-3672	5/8~11	9"	9.00
3436-3276	5/16~18	3	2.40	3436-3680	5/8~11	10	9.50
3436-3292	5/16~18	4	2.50	3436-3698	5/8~11	12	10.00
3436-3318	3/8~16	2	2.01	3436-3722*	3/4~10	4	6.17
3436-3334	3/8~16	3	2.05	3436-3748*	3/4~10	5	7.50
3436-3359	3/8~16	4	2.10	3436-3763*	3/4~10	6	7.66
3436-3375	3/8~16	5	2.71	3436-3771*	3/4~10	7	8.53
3436-3391	3/8~16	6	2.81	3436-3789*	3/4~10	8	10.42
3436-3409	3/8~16	7	3.17	3436-3797*	3/4~10	10	11.00
3436-3417	3/8~16	8	3.63	3436-3805*	3/4~10	12	11.50
3436-3425	1/2~13	2	2.08	3436-3813*	7/8~9	4	7.96
3436-3441	1/2~13	3	2.36	3436-3821*	7/8~9	5	8.20
3436-3466	1/2~13	4	2.73	3436-3839*	7/8~9	6	9.19
3436-3490	1/2~13	5	3.26	3436-3847*	7/8~9	8	10.90
3436-3516	1/2~13	6	3.81	3436-3854*	7/8~9	10	12.85
3436-3524	1/2~13	7	4.46	3436-3870*	1~8	4	7.35
3436-3532	1/2~13	8	5.12	3436-3888*	1~8	5	7.83
3436-3540	1/2~13	9	5.50	3436-3896*	1~8	6	9.54
3436-3581	5/8~11	3	3.33	3436-3904*	1~8	8	11.84
3436-3607	5/8~11	4	4.25	3436-3912*	1~8	10	14.57
3436-3623	5/8~11	5	6.70	3436-3920*	1~8	12	17.29

T-SLOT BOLTS

- Forged steel with milled T-slot guide.
- Black oxide finish.
- Heat treated to HRC 36-40.

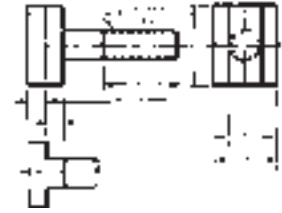

Item#	T-Slot F (In)	Thread (A)	Length Under Head B (In)	Thread Length E	Price (G)
3900-1270	1/2	1/2"~13	2	1	5.76
3900-1272	1/2	1/2"~13	3	1-1/2	5.74
3900-1274	1/2	1/2"~13	4	1-1/2	5.76
3900-1275	1/2	1/2"~13	5	2	5.98
3900-1279	5/8	5/8"~11	2-1/2	1-1/4	7.09
3900-1280	5/8	5/8"~11	3	1-1/2	7.67
3900-1281	5/8	5/8"~11	3-1/2	1-1/2	7.80
3900-1282	5/8	5/8"~11	4	1-1/2	7.95
3900-1283	5/8	5/8"~11	5	1-1/2	8.15
3900-1284	5/8	5/8"~11	6	1-1/2	8.53
3900-1285	5/8	5/8"~11	8	3	8.99
3900-1289	3/4	3/4"~10	3	1-1/4	10.48
3900-1291	3/4	3/4"~10	4	1-1/2	10.50
3900-1292	3/4	3/4"~10	5	1-1/2	11.00
3900-1298	1	1"~8	4	2	18.85

Pro-Series T-SLOT NUTS

- Heat treated steel.
- Black oxide finish.
- Case hardened.
- 1040 Steel.

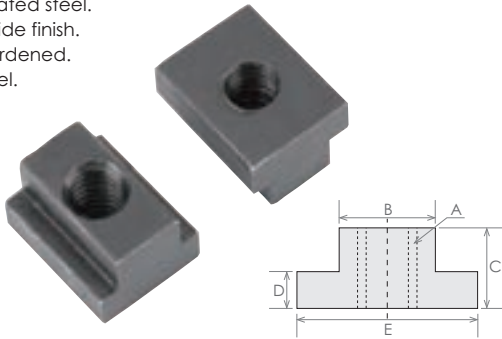

Item#	B (In)	Thread A	C (In)	D (In)	E (In)	Length (In)	Price (H)
3900-1201	3/8	5/16"~18	1/2	3/16	5/8	7/8	2.06
3900-1202	7/16	3/8"~16	1/2	7/32	11/16	7/8	2.26
3900-1203	1/2	3/8"~16	1/2	9/32	7/8	7/8	2.38
3903-1214	9/16	3/8"~16	5/8	11/32	7/8	1-1/8	2.61
3900-1204	9/16	1/2"~13	5/8	11/32	1	1-1/8	4.55
3900-1205	5/8	1/2"~13	5/8	11/32	1-1/8	1-1/8	8.65
3903-1217	11/16	1/2"~13	3/4	7/16	1-1/8	1-1/4	10.08
3903-1218	11/16	5/8"~11	3/4	7/16	1-1/4	1-1/4	6.44
3900-1213	3/4	5/8"~11	3/4	15/32	1-1/4	1-1/4	6.50
3903-1220	13/16	5/8"~11	1	9/16	1-1/4	1-1/2	6.65
3903-1221	13/16	3/4"~10	1	9/16	1-1/4	1-1/2	7.00
3900-1209	7/8	3/4"~10	1	9/16	1-1/2	1-1/2	7.77
3903-1223	1	3/4"~10	1	5/8	1-5/8	1-3/4	7.77
3903-1224	1-1/16	3/4"~10	1-1/8	11/16	1-5/8	2	9.88
3900-1210	1	7/8"~9	1	5/8	1-5/8	1-3/4	12.64
3903-1226	1-1/16	1"~8	1-1/8	11/16	1-5/8	2	12.64

FLANGED NUTS

- Heat treated steel.
- Black oxide finish.
- Case hardened.

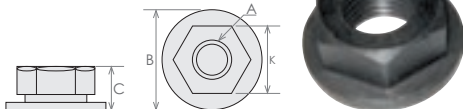

Item#	Thread A	B (Inch)	C (Inch)	K (Inch)	Price (F)
3900-1221	5/16"~18	11/16	9/32	1/2	1.71
3900-1222	3/8"~16	3/4	9/32	9/16	1.87
3900-1224	1/2"~13	1-5/32	1/2	7/8	2.06
3900-1225	5/8"~11	1-5/16	5/8	15/16	3.24
3900-1228	3/4"~10	1-1/2	21/32	1-1/8	8.32
3900-1227	7/8"~9	1-3/4	3/4	1-5/16	8.60

COUPLING NUTS

- Case hardened.
- Black oxide finish.



*Limited Supply

Item#	Thread	Hex	Height	Price (F)
3900-1181	1/4"~20	1/2	5/8	2.26
3900-1183	5/16"~18	9/16	7/8	2.42
3900-1185	3/8"~16	11/16	1	2.89
3900-1187	1/2"~13	7/8	1-1/4	3.55
3900-1189	5/8"~11	1-1/16	1-3/4	4.33
3900-1191	3/4"~10	1-1/4	1-7/8	9.19
3900-1193*	7/8"~9	1-7/16	2-1/4	10.71
3900-1195	1"~8	1-5/8	2-1/2	14.08

HEAVY DUTY HEX NUTS

- Case hardened.
- Black oxide finish.

Limited Supply!



Item#	Thread	Hex	Height	Price (F)	Item#	Thread	Hex	Height	Price (F)
3421-3885	1/4"~20	7/16	7/32	0.34	3421-3935	3/4"~10	1-1/8	41/64	1.17
3421-3893	5/16"~18	1/2	17/64	0.49	3421-3943	7/8"~9	1-5/16	3/4	2.52
3421-3901	3/8"~16	9/16	21/64	0.49	3421-3950	1"~8	1-1/2	55/64	2.90
3421-3919	1/2"~13	3/4	7/16	0.63					

CLAMPING COMPONENTS

10PC MINI STEEL CLAMPING KITS

- Drop forged steel.
- All parts are case hardened and heat treated.

EACH KIT CONTAINS: Two pc each of Step Clamp, Step Block, Stud, T-slot Nut & Flange Nut.



Item#	T-Slot Nut Width	Stud Thread	Clamp Capacity	Price (F)
3906-0320	13x7.5mm	M6x1.00	Up to 22mm	21.49
3906-0322	16x10.5mm	M8x1.25	Up to 45mm	28.97

Pro-Series T - SLOT NUTS-Metric Thread

- Heat treated steel.
- Black oxide finish.
- Case hardened.
- 1040 Steel.

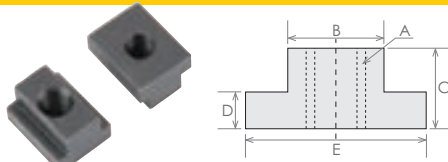

Item#	B (mm)	Thread A	C (mm)	D (mm)	E (mm)	Length (mm)	Price (F)
3903-1236	7.7	M6	9.5	4.5	14	15	2.34
3903-1238	9.7	M8	12	6	15	18	2.34
3903-1240	11.7	M10	14	7	21	22	2.40
3903-1242	13.7	M12	16	8	22	27	2.58
3903-1244	15.7	M14	18	8.5	25	28	3.56
3903-1246	17.7	M16	20	10	28	30	4.35
3903-1248	19.7	M18	24	10.5	32	32	6.02
3903-1250	21.7	M20	28	13	36	36	8.74
3903-1252*	23.7	M22	32	15	40	40	11.24
3903-1254	27.7	M24	36	16	44	44	15.08

*Limited Supply

CLAMPING STUDS-Metric Thread

- Made of alloy steel and heat treated.
- Black oxide finish.



Item#	Stud Thread	Overall Length	Price(F)	Item#	Stud Thread	Overall Length	Price(F)
3436-5001	M8X1.25	75	1.38	3436-5026	M16X2.00	100	2.60
3436-5008	M10X1.25	100	1.12	3436-5028	M16X2.00	150	3.81
3436-5010	M10X1.25	150	1.65	3436-5030	M16X2.00	200	5.12
3436-5013	M12X1.75	75	1.27	3436-5033	M18X2.50	150	4.25
3436-5014	M12X1.75	100	1.49	3436-5037	M20X2.50	100	4.25
3436-5015	M12X1.75	125	1.71	3436-5038	M20X2.50	125	5.12
3436-5016	M12X1.75	150	2.11	3436-5039	M20X2.50	150	5.95
3436-5017	M12X1.75	175	2.33	3436-5040	M20X2.50	175	6.60
3436-5018	M12X1.75	200	2.60	3436-5041	M20X2.50	200	7.44
3436-5022	M14X2.00	150	2.71	3436-5047	M22X2.50	200	8.75
				3436-5052	M24X3.00	200	9.50

Pro-Series COUPLING NUTS-Metric Thread

NEW

- Case hardened.
- Black oxide finish.

MADE IN TAIWAN



Item#	Thread A	Parallel B	Length L	Price (F)
3903-1312	M8x1.25	13	22	2.43
3903-1313	M10x1.5	17	25	1.92
3903-1314	M12x1.75	21	32	2.19
3903-1315	M14x2.0	21	32	2.19
3903-1316	M16x2.0	26	41	2.85
3903-1317	M18x2.5	32	48	4.83
3903-1318	M20x2.5	32	48	7.32
3903-1319	M24x3.0	41	64	11.01

Pro-Series FLANGE NUTS-Metric Thread

NEW

- Heat treated steel.
- Black oxide finish.
- Case hardened.

MADE IN TAIWAN



Item#	Thread	(mm)				Price (F)
		A	B	C	D	
3903-1262	M8x1.25	19	13	8	2	2.43
3903-1263	M10x1.5	22	17	12	3	1.92
3903-1264	M12x1.75	28	21	16	4	2.19
3903-1265	M14x2.0	28	21	16	4	2.19
3903-1266	M16x2.0	35	26	17	5	2.85
3903-1267	M18x2.5	40	32	25	6	4.83
3903-1268	M20x2.5	40	32	25	6	7.32
3903-1269	M24x3.0	50	41	32	6	11.01

BALL PLUNGERS-Metric Thread

- Body Material: 12L14 Steel
- Ball Material: 302 Stainless Steel
- Smallest and lightest spring loaded device
- Side-load tolerant
- Controlled end forces
- Screwdriver installation



Item #	Thread	Dimension (mm)		End Forces(lbs.)		Price (F)
		d (Ball Dia.)	L	Initial	Final	
8017-0100	M4x0.70	2.5	9	2	4.9	3.92
8017-0102	M6x1.00	3.5	13	4.9	14	3.92
8017-0104	M8x1.25	5.0	15	7	19	4.90
8017-0108	M10x1.50	6.0	16	8	24	5.86
8017-0112	M12x1.75	8.0	22	9	29	6.84

CLAMPING KITS & HOLD DOWN SETS

Pro-Series 4PC T-SLOT CLAMPING KITS

- Special made downward force for holding thin or small workpiece
- Used for milling, drilling and EDM with T-slot table
- Quick and easy setting with hex key wrench
- Made of tool steel hardened
- With fitted wood case

Kit includes:
4 pc of t-slot,
clamping pieces and bolts

4PC KIT

Item#	Table Slot	Price (F)
3900-0314	7/16"	103.61
3900-0315	1/2"	111.38
3900-0316	5/8"	123.03
3900-0317	3/4"	176.12



MADE IN TAIWAN

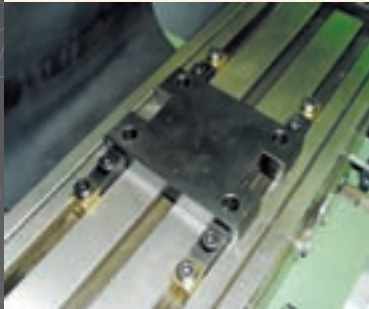

ADJUSTABLE CLAMPING ASSEMBLIES

- One piece assembly allows quick set-up on mill tables with T-slot.
- Instant height adjustment.
- Attached brass shims protect machine table and workpiece



PRICED PER EACH

Item#	T-slot Bolt	Clamping (Stud x Length)	Clamping Range	Each Width	Price (F)
3900-0301	3/8"	3/8"-16 x 3"	Up to 1-3/4"	1-1/4"	18.11
3900-0302	1/2"	1/2"-13 x 4"	Up to 2-1/16"	1-5/8"	18.96
3900-0303	5/8"	5/8"-11 x 5"	Up to 3"	1-7/8"	37.11

T-SLOT CLAMPING KIT



- Quick and easy setting with hex key wrench
- Used for working table with 5/8" T-slot
- Made of hardened tool steel.
- **Kit includes:** 4 pc of t-nuts, 6 pc of clamps, 2 pc of hex keys.
- With fitted case

5/8 T-NUT(1/2"-13)
3900-0318
\$73.65
(F)

HEAVY DUTY HOLD-DOWN CLAMP SETS

- One piece forged steel heads, fully heat treated.
- Allows quick set-up on mill table with T-slot.
- Instant height adjustment.
- Self-positioning.
- Hinged brass swivel rocker protecting workpiece.



PRICED AND SOLD BY PAIR



Item#	T-slot Width	Size of Clamp (WidthxLength)	Clamping Range	Stud Thread	Price (E)
3900-0324	0.62"	1.95x5.5"	Up to 3.5"	1/2-13	94.90
3900-0326	0.74"	2.25x7"	Up to 5"	5/8-11	113.88

HEAVY DUTY HOLD-DOWN CLAMP SETS

- One piece forged steel heads, fully heat treated.
- Allows quick set-up on mill table with T-slot.
- Instant height adjustment.
- Self-positioning.
- Hinged swivel rocker.

PRICED AND SOLD BY PAIR

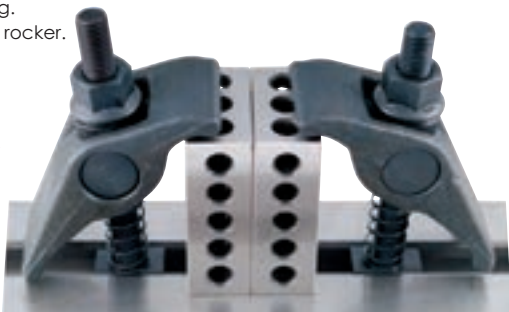

Item#	T-slot	Size of Head	Clamping Range	Load Limit (lbs)	Price (E)
3900-0306	5/8"	4.4 x 1.8"	Up to 3"	16,000	70.25
3900-0307	3/4"	5.0 x 2.1"	Up to 4"	18,000	83.06
3900-0312	7/8"	6.0 x 2.3"	Up to 5"	24,000	109.03

T-SLOT CLEANER

- Fits most of Bridgeport type mill tables.



7016-0030
\$161
(F)

SCREW JACKS

ADJUSTABLE SCREW JACKS

- Ideal for setup work where fine adjustment may be required to level work piece or as a replacement for a step block when using a clamp kit.
- Acme threads
- Made from high quality tool steel.

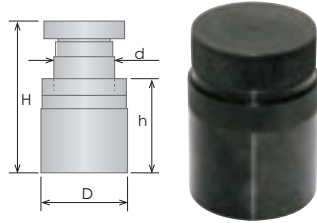

Item#	Adjustable Range	H	h	d	D	Price (F)
3901-0076	23-30mm	30	23	M16	34	6.01
3901-0077	40-60mm	60	40	M16	34	8.03
3901-0078	70-100mm	100	70	Tr30x4	50	19.03
3901-0079	100-140mm	140	100	Tr30x4	50	29.79

Pro-Series SCREW JACKS

- Ideal for setup work where fine adjustment may be required to level work piece or as a replacement for a step block when using a clamp kit.
- Acme threads
- Manufactured from toughened steel



MADE IN TAIWAN

Item#	Adjustable Range	Body Dia.	Weight (lbs)	Price (F)
3901-0072	1.57~2.17"	1.5"	0.7	13.60
3901-0073	2.76~3.74"	1.5"	1.0	15.08
3901-0074	3.94~5.91"	2.0"	2.5	30.21
3901-0075	6~9"	2.83"	10	49.14

Pro-Series SCREW JACKS WITH MAGNETS

- Cross type fixture gives best positioning.
- Built-in magnets.
- Easy to clean chips.
- Adjustable height.

NEW

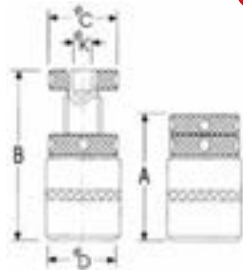

Item#	A	B	(mm) C	D	K	Price (F)
3901-0088	51	65	35	40	11.5	55.35
3901-0090	86	116	40	45	11.5	60.12
3901-0092	110	170	45	50	11.5	95.61

"LITTLE GIANT" STYLE JACK SCREW SETS

- For leveling work on planer beds and upright drills or for setting up machinery



Item#	Lift Range	No. of Pieces	Price (F)
3900-0260	1-1/2 to 2-1/4"	6	23.23
3900-0266	2-1/4 to 3-3/8"	6	30.27

MACHINIST'S JACK

- Tested lifting capacity-approximately 1000 lbs.
- Made of heavy cast steel.
- Adjustable screw and tilting swivel head.
- Adjustable pin and lock nut for permanent positioning.
- 3-4" Range, 1" height adjustment.

3900-0070
\$741 (F)

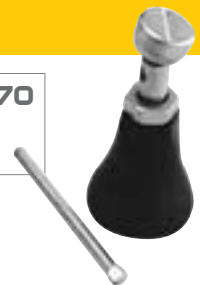

Pro-Series 60-140MM JACK SCREW SET

NEW

- Suitable for irregular workpieces rapid setting.
- Work clamping & support.
- Adjustable height.
- Ideal for work clamping and fixed support.

10PC Set
60-140mm
3901-0095
\$195.00 (F)

Includes:

- 2pcs. 65-90mm jacks
- 2pcs. 90-140mm jacks
- 6pcs. 1A, 2A, 3A, 4A, 5A, 6A pads - 1 each pad



MADE IN TAIWAN

HORIZONTAL Toggle CLAMPS -Flanged Base

- All parts die stamped from solid steel.
- Plastic hand grip for safety & convenience.
- Double plated to avoid rust.
- Carbon steel rivet for durability.

Holding Capacity: 27Kg
Hand Moves: 80°
Bar Moves: 90°



3900-0360 Shown

U-Bar
Weight: 29G

Item#	Bar	Holding Pressure	Mfr. #	Price (F)
3900-0360	U-Bar	60 lbs	201	6.58
3900-0362*	Solid	60 lbs	201A	6.53

*Limited Supply

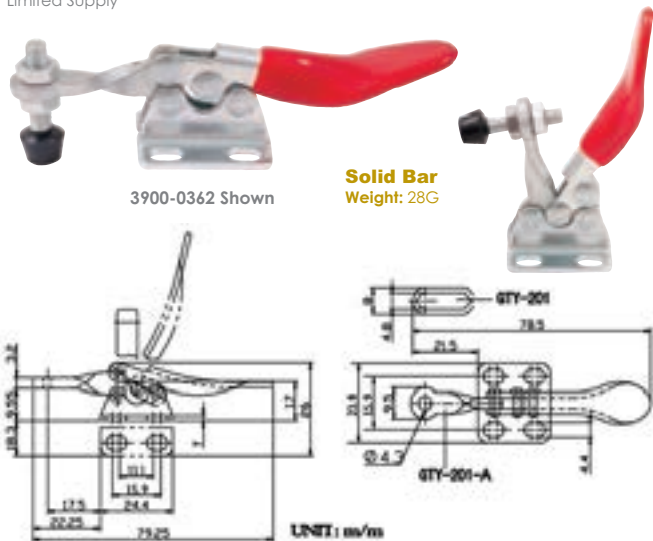

3900-0362 Shown

Solid Bar
Weight: 28G

VERTICAL Toggle CLAMPS -Flanged Base, U-Bar

- All parts die stamped from solid steel.
- Plastic hand grip for safety & convenience.
- Double plated to avoid rust.
- Carbon steel rivet for durability.

Holding Capacity: 200Kg
Weight: 420G
Hand Moves: 64°
Bar Moves: 110°

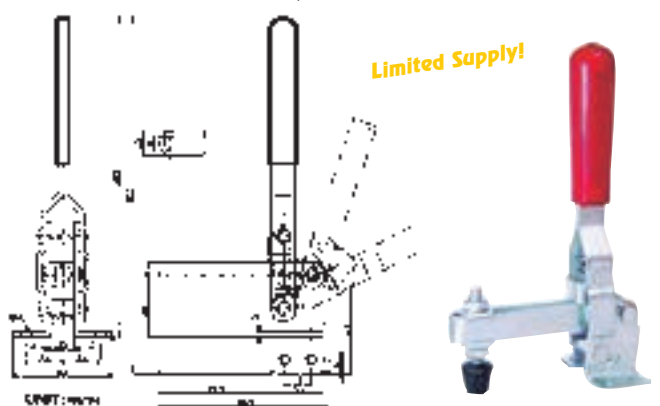

Limited Supply!

Item#	Bar	Holding Pressure	Mfr. #	Price (F)
3900-0339	U-bar	440 lbs	11412	11.13

VERTICAL Toggle CLAMPS -Flanged Base, U-Bar

- All parts die stamped from solid steel.
- Plastic hand grip for safety & convenience.
- Double plated to avoid rust.
- Carbon steel rivet for durability.

Limited Supply!

Holding Capacity: 185Kg
Hand Moves: 46°
Bar Moves: 95°

3900-0334 Shown

Weight: 370G

Item#	Bar	Holding Pressure	Bar Length	Mfr. #	Price (F)
3900-0334	U-bar	400 lbs	41mm	101-D	7.68
3900-0335	U-bar	400 lbs	87mm	101-E	8.82

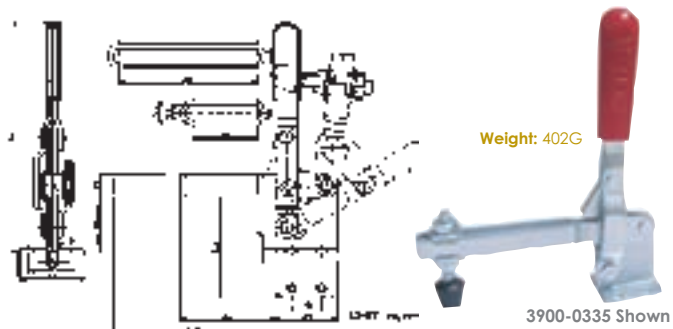

Weight: 402G

3900-0335 Shown

VERTICAL Toggle CLAMPS -Open Bar, U-Bar

- All parts die stamped from solid steel.
- Plastic hand grip for safety & convenience.
- Double plated to avoid rust.
- Carbon steel rivet for durability.

Holding Capacity: 335Kg
Weight: 635G
Hand Moves: 59°
Bar Moves: 106°

Limited Supply!

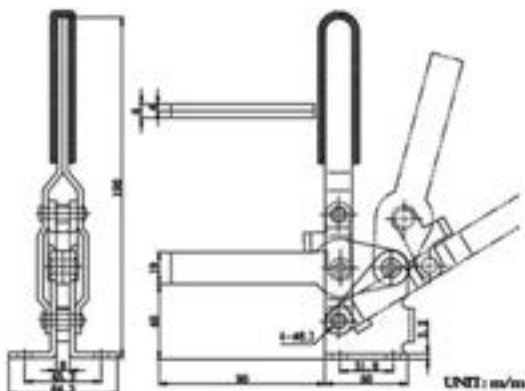

3900-0341 Shown

Item#	Base	Holding Pressure	Mfr. #	Price (F)
3900-0341	Flanged	750 lbs	12265	11.99
3900-0342	Straight	750 lbs	12270	12.58

HIGH QUALITY TOGGLE CLAMPS

VERTICAL Toggle CLAMPS -Flanged Base, U-Bar

- All parts die stamped from solid steel.
- Plastic hand grip for safety & convenience.
- Double plated to avoid rust.
- Carbon steel rivet for durability.

Holding Capacity: 48Kg
Weight: 70G
Hand Moves: 57°
Bar Moves: 101°

Limited Supply!

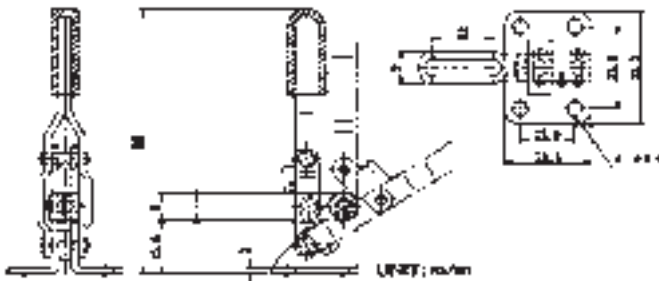

Item#	Bar	Holding Pressure	Mfr. #	Price (F)
3900-0330	U-bar	110 lbs	101-A	5.85

VERTICAL Toggle CLAMPS -Flanged Base, U-Bar

- All parts die stamped from solid steel.
- Plastic hand grip for safety & convenience.
- Double plated to avoid rust.
- Carbon steel rivet for durability.

Holding Capacity: 100Kg
Weight: 118G
Hand Moves: 64°
Bar Moves: 90°

Limited Supply!

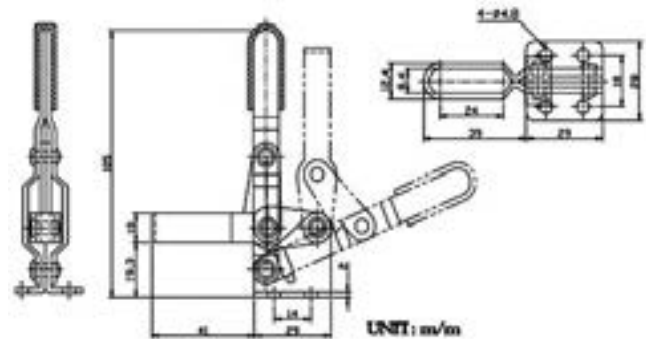

Item#	Bar	Holding Pressure	Mfr. #	Price (F)
3900-0336	U-bar	220 lbs	102-B	7.37

VERTICAL Toggle CLAMPS -Flanged Base, U-Bar

- All parts die stamped from solid steel.
- Plastic hand grip for safety & convenience.
- Double plated to avoid rust.
- Carbon steel rivet for durability.

Holding Capacity: 227Kg
Weight: 346G
Hand Moves: 60°
Bar Moves: 100°

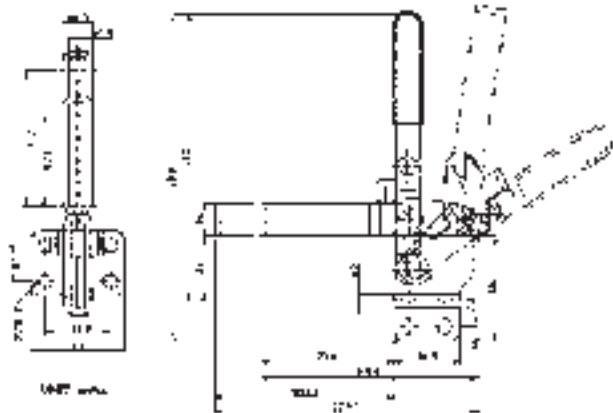

Item#	Bar	Holding Pressure	Mfr. #	Price (F)
3900-0344	U-bar	500 lbs	12130	11.31

SPINDLE ASSEMBLIES

- For use with our toggle clamps
- Zinc plated.
- Black neoprene spindle cap (except where noted)

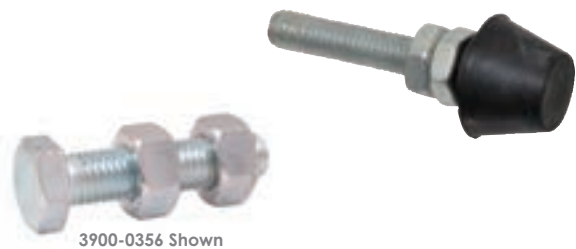

3900-0356 Shown

Item#	Screw Size	Used on Clamp Item#	Price (F)
3900-0350*	M5 x 40mm	101-A	1.21
3900-0353	M8 x 60mm	101-D, 101-E, 12130, 203-F, 203-FL, 225-D	1.57
3900-0356	M10 x 50mm (steel head)	304-E, 305-E	1.57
3900-0357*	M8 x 50mm (steel head)	11412, 304-C, 305-C, 302-F, 36020	1.21
3900-0358	M4 x 20mm	201, 201-A	1.57
3900-0359	M12 x 50mm (steel head)	304-H, 305-H	3.90

*Limited Supply

HIGH QUALITY TOGGLE CLAMPS

HORIZONTAL Toggle CLAMP -Flanged Base, U-Bar

- All parts die stamped from solid steel.
- Double plated to avoid rust.
- Plastic hand grip for safety & convenience.
- Carbon steel rivet for durability.



REGULAR BAR

Item#	Bar	Holding Pressure	Mfr. #	Price (F)
3900-0370	U-Bar	880 lbs	200W	12.79



REGULAR BAR WITH LOCK

Item#	Bar	Holding Pressure	Mfr. #	Price (F)
3900-0375*	U-Bar	880 lbs	220WH	12.58

*Limited Supply

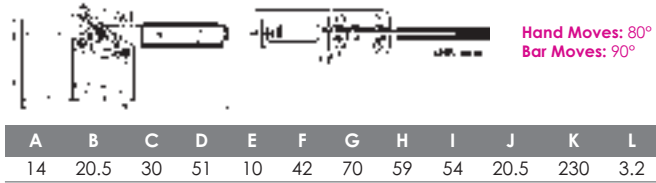

A	B	C	D	E	F	G	H	I	J	K	L
14	20.5	30	51	10	42	70	59	54	20.5	230	3.2

HORIZONTAL Toggle CLAMPS -Flanged Base, Long U-Bar

Limited Supply!

- All parts die stamped from solid steel.
- Double plated to avoid rust.
- Plastic hand grip for safety & convenience.
- Carbon steel rivet for durability.



Item#	Bar	Holding Pressure	Mfr. #	Price (F)
3900-0377	Long U-Bar	880 lbs	220-WHL	13.75



Item#	Bar	Holding Pressure	Mfr. #	Price (F)
3900-0372	Long U-Bar	880 lbs	200WL	10.01

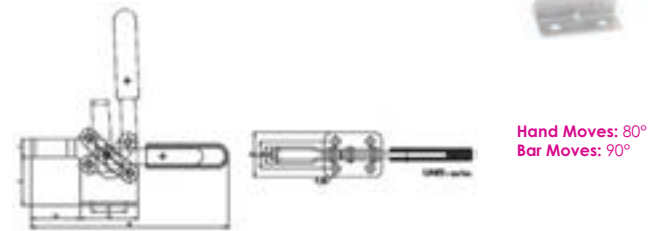

A	B	C	D	E	F	G	H	I	J	K	L
14	20.5	30	51	10	42	70	110	54	20.5	280	3.2

HORIZONTAL Toggle CLAMPS -Flanged Base, U-Bar

- All parts die stamped from solid steel.
- Double plated to avoid rust.
- Plastic hand grip for safety & convenience.
- Carbon steel rivet for durability.

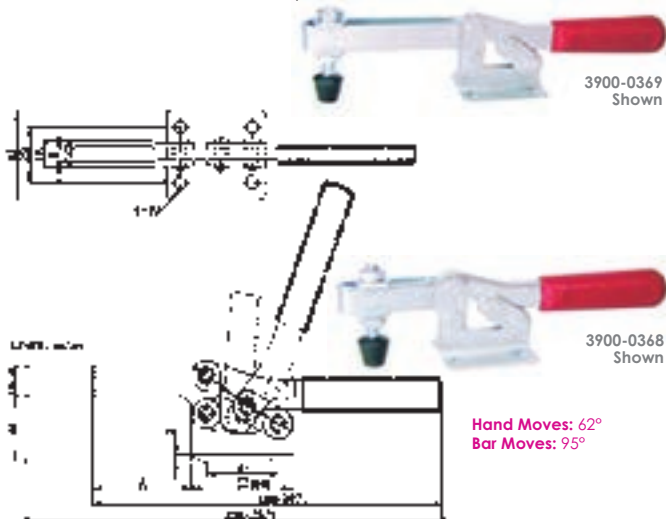

Item#	Bar	A	Holding Pressure	Mfr. #	Price (F)
3900-0368*	U-bar	2.24"	500 lbs	203-F	9.09
3900-0369	Long U-Bar	3.70"	500 lbs	203-FL	11.47

*Limited Supply

HORIZONTAL Toggle CLAMPS -Flanged Base, U-Bar

- All parts die stamped from solid steel.
- Double plated to avoid rust.
- Plastic hand grip for safety & convenience.
- Carbon steel rivet for durability.

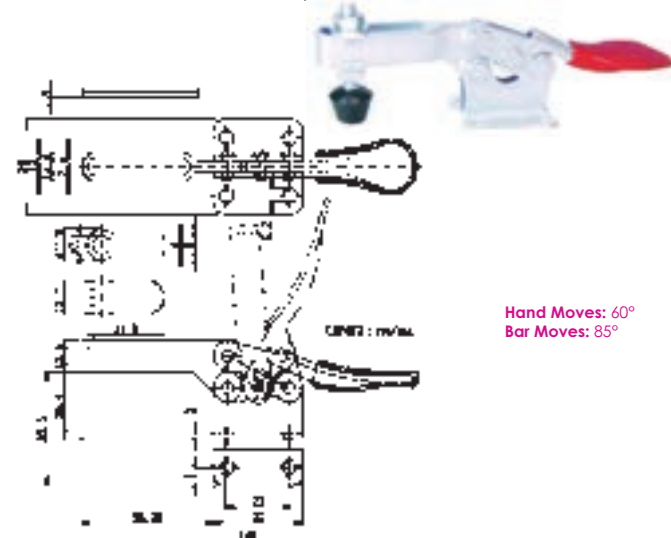

Item#	Bar	Holding Pressure	Mfr. #	Price (F)
3900-0365	U-bar	200 lbs	201B	8.42

HIGH QUALITY TOGGLE CLAMPS

MACHINE TOOL ACCESSORIES

PUSH/PULL TOGGLE CLAMP

- All parts die stamped from solid steel.
- Double plated to avoid rust.
- Ideal for electronic applications and similar small applications.

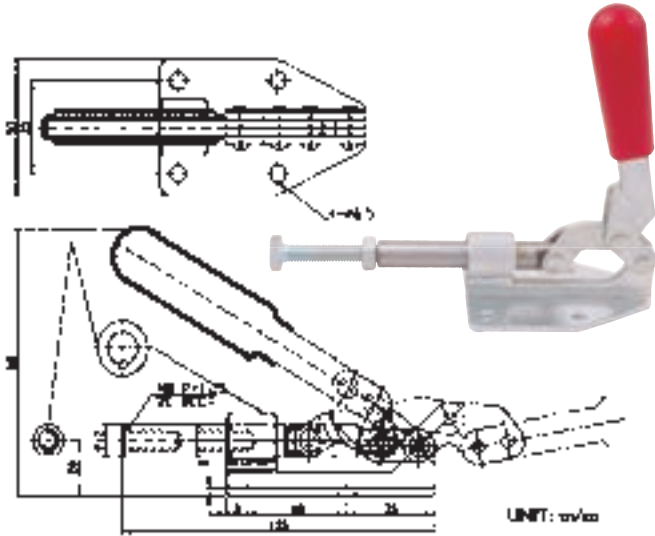

Item#	Handle Move	Holding Capacity	Plunger Travel	Mfr. #	Price (F)
3900-0397	144°	400 lbs	30mm	36020	12.82

PUSH/PULL TOGGLE CLAMP

- All parts die stamped from solid steel.
- Double plated to avoid rust.
- Ideal for electronic applications and similar small applications.

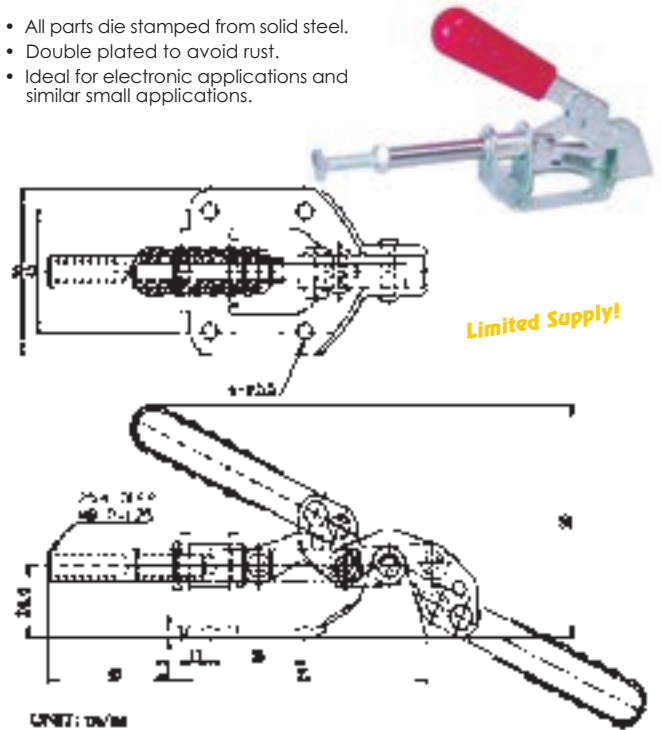

Item#	Handle Move	Holding Capacity	Plunger Travel	Mfr. #	Price (F)
3900-0398	180°	300 lbs	32mm	302-F	9.79

HEAVY DUTY PUSH/PULL TOGGLE CLAMP

- All parts die stamped from solid steel.
- Double plated to avoid rust.
- Ideal for electronic applications and similar small applications.

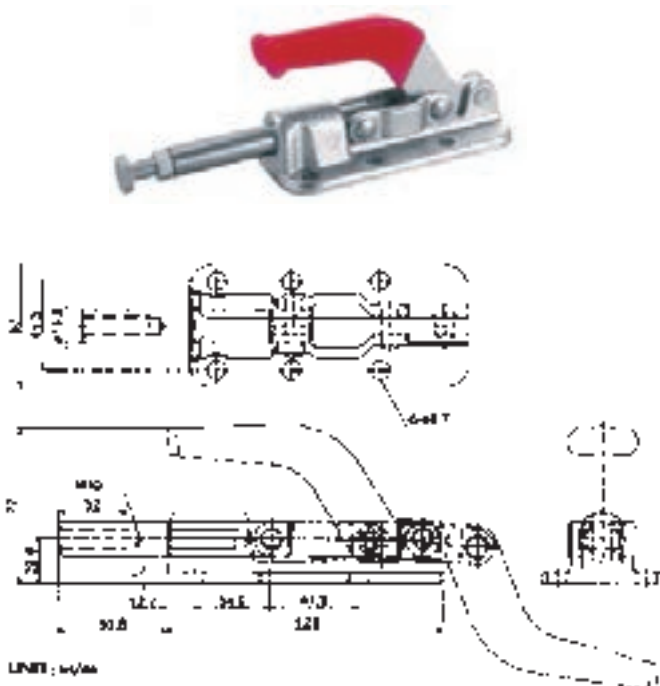

Item#	Handle Move	Holding Capacity	Plunger Travel	Mfr. #	Price (F)
3900-0399	180°	2500 lbs	50mm	36330	24.34

HORIZONTAL Toggle CLAMPS -Flanged Base, U-Bar

- All parts die stamped from solid steel.
- Double plated to avoid rust.
- Plastic hand grip for safety & convenience.
- Carbon steel rivet for durability.

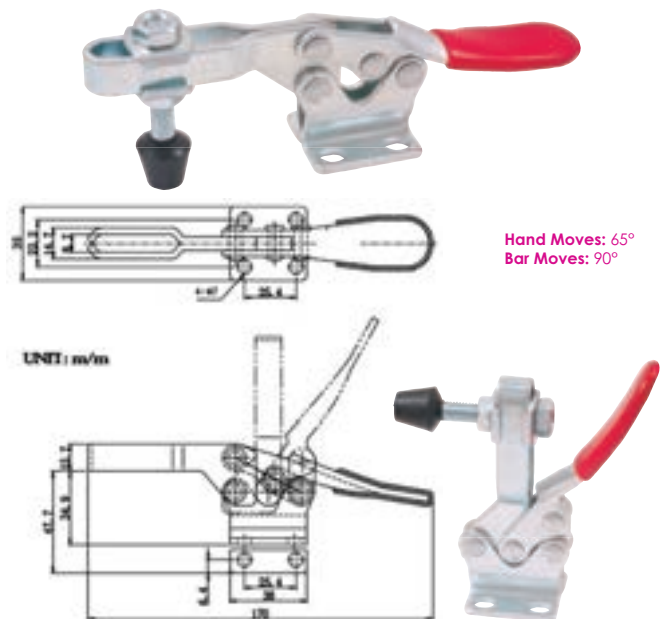

Item#	Bar	Holding Pressure	Mfr. #	Price (F)
3900-0380	U-bar	500 lbs	225-D	10.30

HIGH QUALITY TOGGLE CLAMPS

PULL ACTION LATCH TOGGLE CLAMP

- All parts die stamped from solid steel.
- Double plated to avoid rust.
- Ideal for electronic applications and similar small applications.

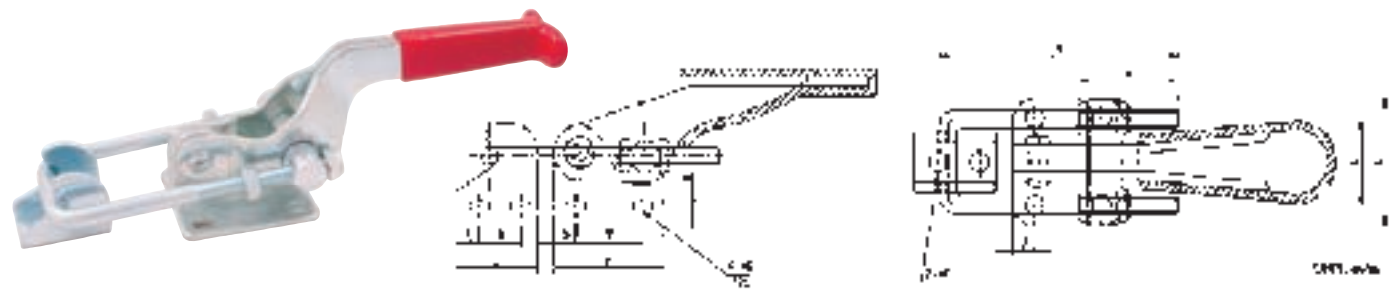

Item#	Holding Capacity	Mfr. #	Price (F)	A	B	C	D	E	F	G	H	I	J	K	L	M	N
3900-0402	350 lbs	40323	7.25	6	9.9	19.8	5.2	15.9	26.2	4.4	2	29.3	5.2	19	28.2	24	57
3900-0403	660 lbs	431	10.06	6.8	11.5	25.4	6.4	19	39.7	6.7	3.2	41.3	6.35	31.6	44.5	38	90

HOOK TYPE PULL ACTION CLAMP

- Excellent for many types of latching operations.
- With base bolted or welded in place, unit can be use for latching pressure vessels, etc.
- Pull bar is threaded for convenient adjustment
- Furnished with red vinyl grip

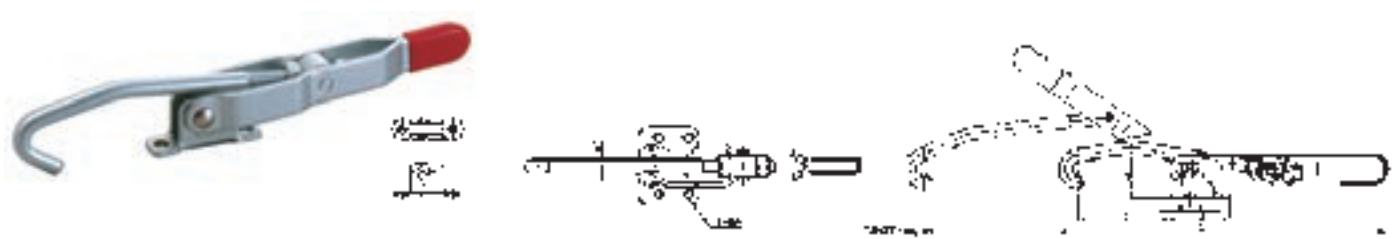

Item#	Holding Capacity	Mfr. #	Price (F)	A	B	C	D	E	F	G	H	L	J
3900-0408	380 lbs	451	10.06	5.6	12.7	19	38.1	217	54.88	8	48	33.2	36.5
3900-0409	750 lbs	40371	18.80	8.7	-	31.8	47.6	286	79.4	9.5	65.7	48.2	57.3

DELUXE PUSH/PULL

- All parts die stamped from solid steel.
- Plastic hand grip for safety & convenience.
- Double plated to avoid rust.
- Carbon steel rivet for durability.

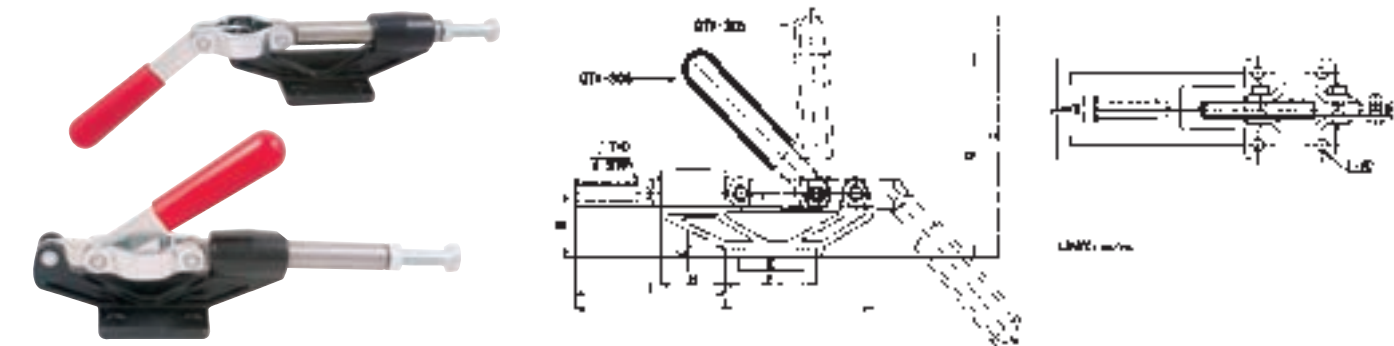

Item#	Handle Move	Mfr. #	Holding Capacity	Price (F)	A	B	C	D	E	F	G	H	I	J	K	L	M	O	Stroke
3900-0388	45°	304-C	500 lbs	17.45	12.7	41.1	57.2	6.7	35	52.4	4.8	20.6	52.4	M8P=1.25	30.2	125.4	25.4	74.6	32
3900-0389*	90°	305-C	500 lbs	14.76	12.7	41.1	57.2	6.7	35	52.4	4.8	20.6	52.4	M8P=1.25	30.2	125.4	25.4	90.5	32
3900-0390	45°	304-E	800 lbs	14.72	16	41.1	57.2	8.3	41.1	58.8	4.8	31.8	81	M10P=1.5	39.2	158.8	31.8	98.4	42
3900-0391	90°	305-E	800 lbs	16.25	16	41.1	57.2	8.3	41.1	58.8	4.8	31.8	81	M10P=1.5	39.2	158.8	31.8	122.8	42
3900-0392*	45°	304-H	1500 lbs	20.09	19.2	50.8	72	8.3	50.8	72	6.4	50.8	120.8	M12P=1.75	49.2	238.2	50.8	133.4	60
3900-0393	90°	305-H	1500 lbs	21.37	19.2	50.8	72	8.3	50.8	72	6.4	50.8	120.8	M12P=1.75	49.2	238.2	50.8	171.6	60

* Limited Supply

DRILL PRESS & CROSS SLIDE VISES

Pro-Series ANGLE DRILL PRESS VISES - With Base

- Full 90° adjustment, horizontal to vertical.
- Two bolt lugs on base for setting on machine table.
- One grooved and one plain jaw plate.
- Swivel base providing 360° rotation.



Item#	Jaw Width	Jaw Opening	Jaw Depth	Wt. (Lbs.)	Price (E)
3901-1735	4"	4"	1.8"	38	220.22
3901-1737	6"	6"	2.1"	86	496.98

DELUXE TILT VISES

- Full 90° horizontal to vertical adjustment.
- Base with multi-bolt slots for working table setting.
- One side of vise with angle dial and another side with lock knob very convenient for angle set-up.
- Strong cast iron with rail for secure angle adjustment.

Item#	Jaw Width	Jaw Depth	Jaw Opening	Price (F)
3900-2683	3"	1-3/8"	3"	74.85
3900-2684	4"	1-5/8"	4"	103.82

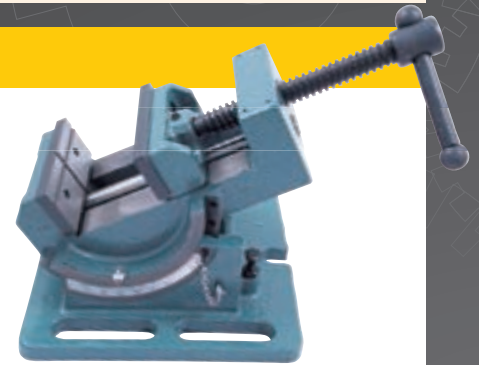
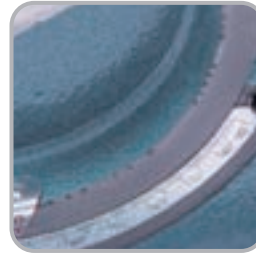

SUPER CROSS SLIDE VISES

- Suitable for clamping soft materials such as aluminum, copper, etc.
- Secures firmly on drill press table and moves similar to vertical mill.
- Accurate positioning in two directions(crossed).
- Each dial is graduated in .1mm increments for precise adjustments and easily adjusts to 0.
- Ball crank handles are solid and balanced.
- Feed screws have precision cut acme threads.
- Dial in 1mm increments.
- High grade cast body.
- Heat treated steel jaws.
- Jaws interchangeable with Wilton.

Item#	Jaw Width	Jaw Depth	Cross Travel	(Inch) Jaw Opening	Longitudinal Travel	Weight lbs.	Price (F)
3901-2703	3	1.38	3	3	5	16	115.49
3901-2704	4	1.81	4	4	5	20	129.38
3901-2705	5	1.97	5	5	6	41	208.81
3901-2706	6	2.09	6	6	8	60	281.94
3901-2708	8	2.09	8	8	8	77	383.86



Pre-Series X-Y CROSS SLIDE VISES

- Suitable for clamping soft materials such as aluminum, copper, etc.
- Secures firmly on drill press table and moves similar to vertical mill.
- Accurate positioning in two directions(crossed).
- Each dial is graduated in .1mm increments for precise adjustments and easily adjusts to 0.
- Ball crank handles are solid and balanced.
- Feed screws have precision cut acme threads.
- High grade cast body.
- Heat treated steel jaws.

HANDLES ARE CLEAR FROM MILL TABLE

Item#	Jaw Width	Jaw Depth	Cross Travel	Jaw Opening	Longitudinal Travel	Weight lbs.	Price (F)
3900-2703	3"	1-1/8"	3"	2.80"	5"	17	113.37
3900-2704	4"	1-7/16"	4"	3.80"	6"	21	139.85
3900-2706	6"	1-11/16"	6"	5.80"	8"	63	315.38

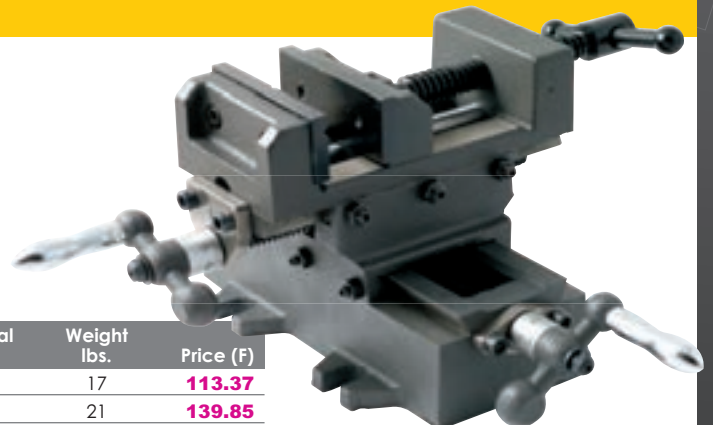

DRILL PRESS VISES

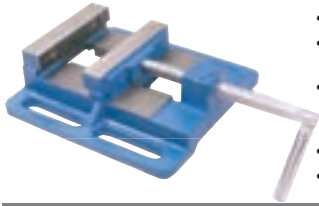

- Four slots for easy clamping to tables.
- Body and slide made of selected cast iron.
- Guiding groove controls the parallel movement and rigidity of moveable jaw.
- Replaceable steel jaws.
- Handle adjusts to any angle.

Item#	Jaw Width	Jaw Opening	Jaw Depth	Price (F)
3900-0177	3"	3"	1"	22.36
3900-0174	4"	4"	1-3/8"	27.48
3900-0175	5"	5"	1-1/2"	42.77
3900-0176	6"	6"	1-5/8"	46.83

DRILL PRESS VISES

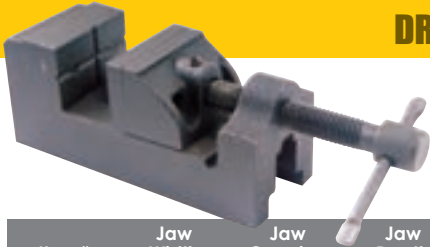

- Grooved jaw

Item#	Jaw Width	Jaw Opening	Jaw Depth	OAL	Price (F)
3900-1730	1-1/2"	1-1/2"	1"	5-1/4"	24.98
3900-1731	2-1/2"	2-1/2"	1-1/2"	7-1/2"	31.89
3900-1732	3-1/2"	3-1/2"	1-3/4"	9-1/4"	43.18

Pro-Series LOW PROFILE DRILL PRESS VISES

- Low profile clearance provides increased working room on machine table.
- Hardened V-groove jaws hold round shapes in either vertical or horizontal position.
- Slip handle allows for easy turning and added leverage body and slide are made of selected fine grain cast iron.
- Four slots for secure mounting to machine table.
- Base and bed parallel to 0.001".
- Jaws & parts interchangeable with Wilton.

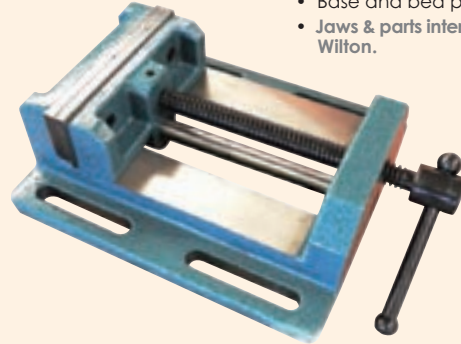

Item#	Jaw Width	Jaw Opening	Throat Depth	Wt. (Lbs.)	Price (F)
3901-0173	3"	3"	1-1/8"	9	45.19
3901-0174	4"	4"	1-3/4"	12	65.95
3901-0176	6"	6"	2"	32	145.11
3901-0178	8"	8"	2"	51	242.84

Pro-Series 5" SUPER DUTY DRILL/MILL VISE

- Made of top grade strong stress relieved casting.
- Quick action handle with hex end for strong force tightening.
- Grooved jaws.
- All working surfaces are ground and hardened.

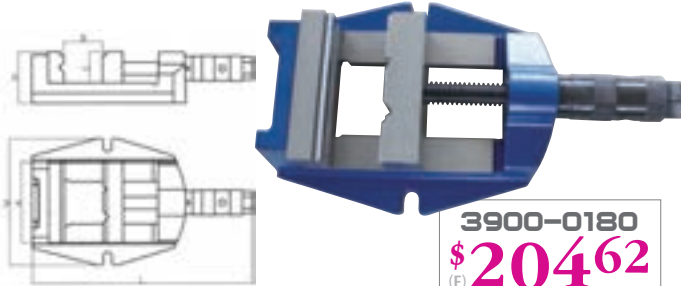

3900-0180
\$**204.62**
(F)

Unit: mm

Jaw Width	Jaw Opening	Jaw Depth	OAL	Base Width	Height	Wt. (Lbs.)
A	B	C	L	W	H	
125	90	50	350	200	82	23

Pro-Series INDUSTRIAL DRILL PRESS VISES

- Precision machined on 4 sides, can be used on base, sides or end.
- Body & slide are made of selected fine grain cast iron.
- Hardened steel V-groove jaws hold round shapes in both vertical or horizontal position.
- Slip handle allows for easy turning and added leverage.
- Precision ground for square and parallel accuracy to +/- 0.001" per inch.
- Jaws & parts interchangeable with Wilton.

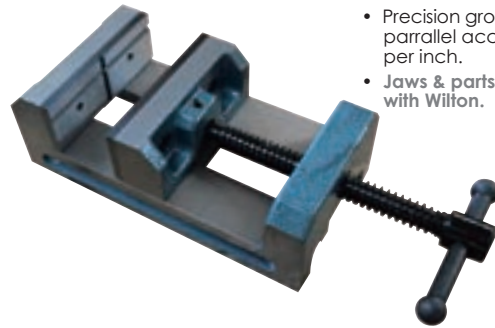

Item#	Jaw Width	Jaw Opening	Jaw Depth	Wt. (Lbs.)	Price (F)
3901-0184	4"	4"	1.5"	9.5	54.33
3901-0186	6"	6"	2.0"	35	179.52

Pre-Series QUICK SLIDE DRILL PRESS VISES

- Made of high grade strong stress relieved iron casting.
- The 4&6" have 1/2" lugs on each side for mounting.
- The 3" features 1/2" slots for mounting.
- Precision ground.

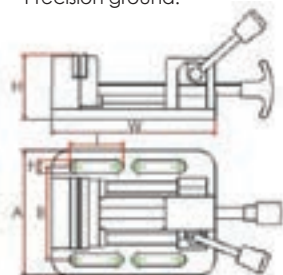

3900-0183 Shown

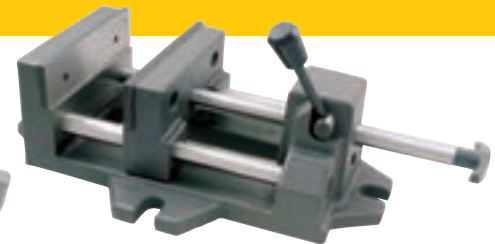

3900-0186 Shown

Item#	Jaw Width	Jaw Opening	Jaw Depth	(mm)						Price (F)
				A	B	H	h	I	W	
3900-0183	3"	3	1	140	104	72	183	14	60	53.07
3900-0184	4"	4	1-1/2	152	126	90	308	14	--	100.10
3900-0186	6"	6	1-7/8	230	192	109	368	18	--	161.76

WISE JAWS

MAGNETIC VISE JAWS

- Designed to protect both the vise jaws and the workpiece from marring and distortion during any clamping application.
- Constructed from a hardened aluminum alloy with two built-in circular permanent magnets on the backside which holds the workpiece securely to the vise.
- Different face material to ensure tight holding of different shapes and material of workpiece.

SOLD BY PAIR

SOFT FACE

Aluminum alloy design includes straight grooves to compensate for the unevenness of the workpiece.



PRISM FACE

Jaw construction includes a 120° horizontal V-groove and a vertical V-groove for marking out and center punching. Ideal for light tapping and thread cutting applications.



RUBBER FACE

Aluminum alloy with synthetic rubber cover. Jaw cap conforms to workpiece and grips firmly without slipping while protecting work surface.

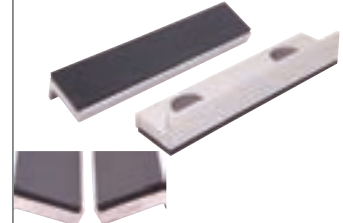

Jaw Width	Jaw Height	Soft Face		Prism Face		Rubber Face	
		Item#	Price (F)	Item#	Price (F)	Item#	Price (F)
3"	1-1/8"	3900-2143	9.97	3900-2261	9.97	3900-2271	12.47
4"	1-1/8"	3900-2145	15.88	3900-2263	14.29	-----	-----
5"	1-1/8"	3900-2147	18.23	3900-2265	14.88	3900-2275	16.00
6"	1-1/8"	3900-2149	18.99	-----	-----	3900-2277	16.88
8"	1-1/8"	3900-2152	18.72	-----	-----	3900-2279	21.06

ALUMINUM VISE JAWS

- Fits **Kurt Anglock™** & similar precision milling machine vises.
- Perfect for easy and quick set-ups, reducing down time.
- Customize jaws for drill or mill features.
- Reusable, saving you time and money.

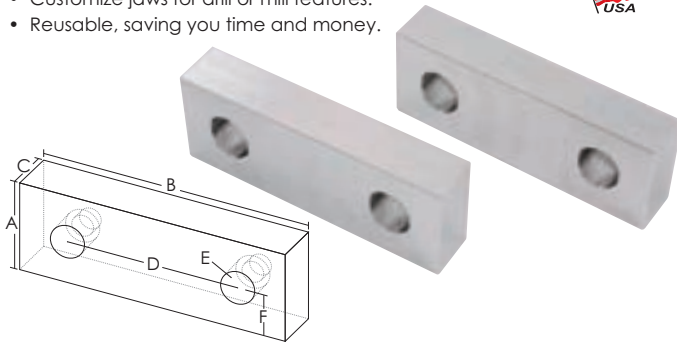

Item#	Vise Size	Height A	Length B	Hole Space D	Screw Size E	Hole Dist. F	Width C	Set of 2 Price (E)
3900-2180	4"	1-3/4	4	2-1/2	3/8	.687	3/4	41.21
3900-2184	4"	2	5	2-1/2	3/8	.687	1	33.50
3900-2187	6"	2	6	No Hole	---	---	1	27.12
3900-2188*	6"	2	6	3-7/8	1/2	.937	1	42.96

* Top/Bottom REVERSIBLE

ALUMINUM QUICK LOCK VISE JAWS

- Fits **Kurt Anglock™** & similar precision milling machine vises.
- Easy and quick set-ups.
- Machinable vise jaws for drill or mill features.
- Price is for set of 2 jaws.

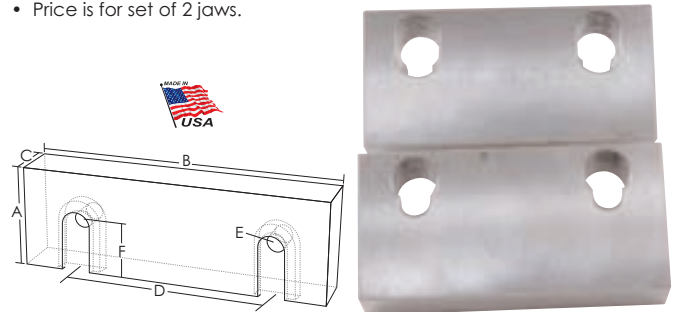

Item#	Vise Size	Height A	Length B	Hole Space D	Screw Size E	Hole Dist. F	Width C	Set of 2 Price (E)
3900-2191	4"	2	4	2-1/2	3/8	.687	1	54.96
3900-2193	6"	2	6	3-7/8	1/2	.937	1	47.24
3900-2194	6"	3	6	3-7/8	1/2	.937	1	107.62
3900-2195*	6"	3	6	3-7/8	1/2	.937	2	79.58

* Limited Supply

Pro-Series PRISMA VISE JAWS

- Multi-function V-shape jaw can hold round and square workpiece.
- Made of high grade tool steel hardened and precision ground.
- Squareness and Parallelism: 0.0002".

Limited Supply!



FOR "Vertex" K-TYPE VISES

Item#	Fit Vise	Height	Length	Width	Screw Size	Hole Space	Price (F)
3900-2169	VK-5	1.50"	5.2"	.38"	M8	3.15"	60.15
3900-2170	VK-6	1.69"	6.0"	.38"	M10	3.55"	69.65
3900-2171	VK-8	2.48"	8.0"	.49"	M10	4.72"	88.66

Pro-Series PRISMA VISE JAWS

- Multi-function V-shape jaw can hold round and square workpiece.
- Made of high grade tool steel hardened and precision ground.
- Squareness and Parallelism: 0.0002".
- Fits "Kurt" vises & American standard milling machine vises.

Limited Supply!



For Kurt Vise

Item#	Fit Vise	Height	(Inch) Length	Screw Size	Hole Space	Price (F)
3900-2175	4	1.42	4.1	3/8	2.500	56.98
3900-2176	5	1.50	5.2	3/8	2.500	63.32

UNIVERSAL VISE JAWS WITH WORK STOP

- Multi-function V-shape jaw can hold workpiece at horizontal and vertical position.
- Made of high grade tool steel hardened and precision ground.
- Squareness and Parallelism: 0.0002".
- Will fit vise jaw with same or similar width.
- Two set screws are attached to vise and one long set screw used as work stop.

MADE IN TAIWAN



Item#	Fits Vise	Dimension (mm)					Wt. (lbs)	Price (€)
		A	B	C	D	V		
3900-2164	4"	145	110	49	38	32	3.5	134.91
3900-2165	5"	175	140	49	39	32	4.0	146.68
3900-2166	6"	190	160	53	40	32	4.8	164.27
3900-2167	8"	245	210	76	42	32	9.0	193.61

MILL VISE STOP - Fits 3 & 4"

- Fits the most popular machine vises.
- Bolt-on design, requires no modification to vise.
- Will work in left or right hand location.



FITS 3 & 4"
3900-2122
\$22²²
(F)

QUICK CLAMP WORK STOP

- Fits mill vises with 1/2-1" jaws
- steel body 1" wide x .38" height
- Very handy for small parts that do not require the full length
- Clamps quickly & easily to the top of existing hard jaws or soft jaws



3900-2131
\$1236
(F)

MILL VISE STOP - Fits 5 & 6"

- Fits the most popular machine vises.
- Bolt-on design, requires no modification to vise.
- Will work in left or right hand location.

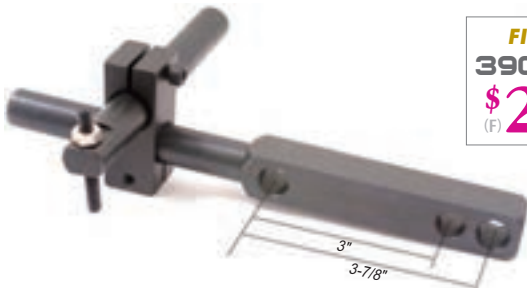

FITS 5 & 6"
3900-2123
\$2498
(F)

3900-2120
\$612
(F)



WISE WORK STOP

- To fit angle lock type vises.
- Single thumb screw tightens clamp to vise jaw.
- Two ground pins on both sides of clamp.
- Easily mounts to the top of most vise jaws.
- 7/8" capacity.

UNIVERSAL WORK STOP

- Serves as a rigid stop for milling set-up.
- Made of hardened tool steel.
- Use with vises, angle plates, jigs, etc.
- Column: 5/8 x 6-1/4".
- Base: 5/8 x 2 x 4-3/8".
- Rod: 3/8 x 10".



3900-2125
\$1643
(F)

Pro-Series MULTI AXIS WORK STOP -5/8" TABLE SLOTS

- For use with repetitive jobs that require exact placement in the vise.
- 5 Axis Adjustment, 1/4" diameter x 6" length stop rod, locking lever can be positioned at 360 degrees.
- T nut fits 5/8" table slots.
- Height 8", Length 8"
- Capacity-approximately 700 lbs.



Limited Supply!

3900-2118
\$21154
(F)

MILLING VISES & HANDLES

Pro-Series HEAVY DUTY MILLING VISES

- Precision ground to accuracy.
- Full 360° swivel base with graduation included.
- Used in milling, shaping and drilling machines.

- Lock down design secures the movable jaw, preventing it from lifting upwards.
- Angle-Tight Positive-Lock style-jaws are interchangeable with American Standard vises.

Jaw Dimensions

Jaw Width	A	B	C (mm)	D	E	F
3"	80	24	45	12.5	7	9.5
4"	100	32	63.5	16	9	12
5"	125	40	76	18	9	14
6"	160	45	98.4	23.9	13	19
8"	200	50	120.6	31	13	19



HIIP PRO-SERIES
3900-2103 Shown

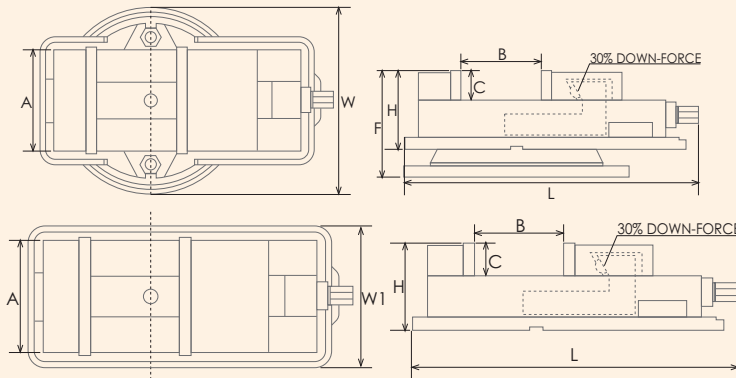

Jaw Width A	Jaw Opening B	Jaw Height C	(Inch) OAL L	Width of Swiv Base W	Width of Vise Base W1	Vise Height H	Height with Base F	Wt. (LBS.)	VISE ONLY		VISE W/SWIV. BASE	
									Item#	Price (F)	Item#	Price (F)
3	3.74	0.940	10.60	6.70	4.7	2.76	3.74	15/22	3900-2223	156.00	3900-2104	180.29
4	5.12	1.181	12.80	8.70	6.3	3.54	4.72	25/40	3900-2224	179.66	3900-2102	188.24
5	5.71	1.575	14.80	8.70	7.0	3.94	5.12	48	-----	-----	3900-2101	286.49
6	8.00	1.932	18.70	11.0	8.9	4.53	5.98	68/86	3900-2226	279.40	3900-2103	347.88
8	9.25	1.969	20.90	16.1	--	4.92	7.87	130	-----	-----	3900-2106	679.38

VISE JAWS-Replacement



Set of 2

Item#	Fit Vise	Price (F)
3900-2133	3"	20.44
3900-2134	4"	32.73
3900-2136	6"	40.48

JAW BLOCKS-Replacement



Item#	Fit Vise	Price (F)
3900-2140	3"	30.28
3900-2141	4"	38.94
3900-2142	6"	85.25

SWIVEL BASES-Optional

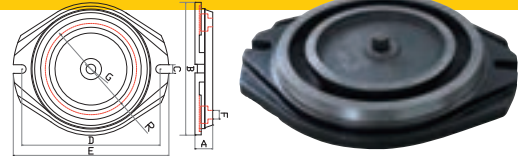

Item#	Fit Vise	(mm)								Price (F)
		A	B	C	D	E	F	G	R	
3900-2233	3"	25	168	12	160	187	10	14	98	24.54
3900-2234	4"	30	216	14	217	244	12	20	132	40.92
3900-2236	6"	37	285	18	284	322	18	20	190	65.49

QUICKIE VISE HANDLES

- Fits all vises with 3/4" hex
- Speed up opening and closing of machine vises.
- Provides faster and more efficient production.
- Short turning radius for clamping of more delicate parts.
- Machined anodized aluminum.



SINGLE HUB
3900-2107
\$1978
(F)

DOUBLE HUB
3900-2108
\$3265
(F)

REPLACEMENT VISE HANDLES



1/2" Hex Hub
3900-2137
\$2454
(F)

9/16" Hex Hub
3900-2138
\$2863
(F)

3/4" Hex Hub
3900-2139
\$3273
(F)

VISE SPEED HANDLE

- Designed for 6" milling vise.
- Speed up the clamping force of vise.
- Fits most milling vises.



3/4" Hex Hub
3900-0202
\$3080
(F)

Ultra-Series ANGLE-TIGHT POSITIVE-LOCK MILLING VISES



- Super precision ground to accuracy. High quality.
- Totally enclosed heat treated screw.
- Smooth operation, high repeatability.
- Angle-Tight Positive-lock style-lock down type jaws.
- Jaws interchangeable with American standard vises.

OPTIONAL Swivel Base for 6" Vise
3900-2207
\$9140
 (F)
 Weight 29 lbs.

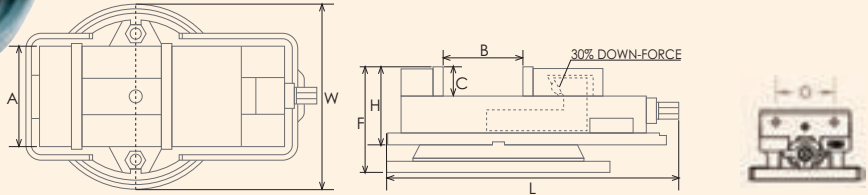

SHOWN WITH OPTIONAL SWIVEL BASE

Item#	Jaw Width A	Jaw Opening B	Jaw Depth C	(Inch) OAL L	Vise Height H	Height with Base F	W	Jaw Hole Space O	With Swivel Base	Weight (lbs.)	Price (F)
3900-2203	3	3	1.00	11.00	3-5/32	4-9/32	7-9/32	1.772"	Yes	28	347.01
3900-2204	4	4	1.20	13.50	3-37/64	5-1/32	9-7/32	2.500"	Yes	52	392.70
3900-2205	5	5	1.50	17.30	4-1/16	5-9/16	9-49/64	2.992"	Yes	71	426.92
3900-2206	6	7.5	1.95	21.00	4-27/32	---	---	3.874"	No	86	479.05

Pro-Series 6" PRECISION MILLING VISE -With 8.6" Jaw Opening

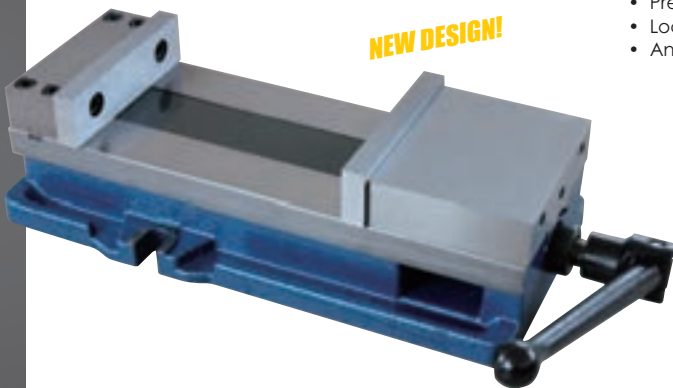

NEW DESIGN!

- Precision ground to accuracy to .0004" on parallelism and .0008" on squareness.
- Lock down design secures the movable jaw, preventing it from lifting upwards.
- Angle-Tight Positive-Lock style-jaws are interchangeable with American Standard vises.

6" VISE
3900-2246
\$57826
 (F)

OPTIONAL BASE Fits Vise 6"
3900-2236
\$6549
 (F)

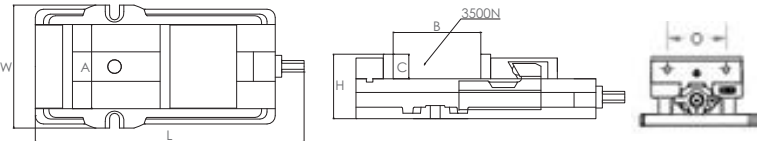

Item#	Jaw Width	Jaw Opening	Weight (LBS.)	A	B	C	(Inch) L	W	H	Jaw Hole Space O
3900-2246	6"	8.6"	75	6	8.6	1.77	19.5	9.2	4.65	3.874"

SUPER-LOCK VISE FOR NC/CNC MACHINES

- Lock down type.
- Ideal for all types of milling, grinding, drilling and tapping application in multiple vise set-ups.
- Flatness of all sides to .001" guaranteed.
- Mounting in 3 modes: upright, left and right side.
- Both sides parallel to each other to .0005" per 4".
- Up to 3000 N clamping force.

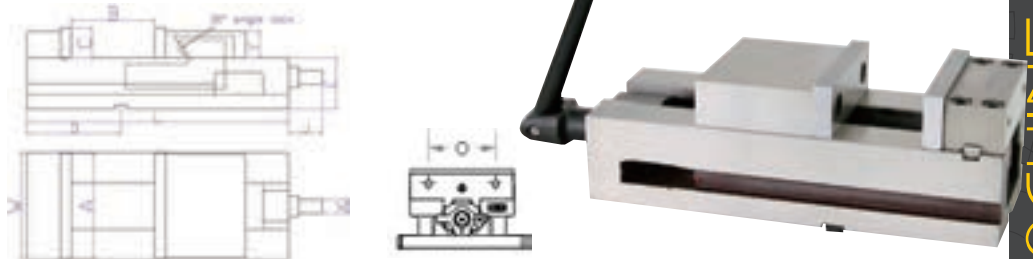

Item#	Jaw Width (Inch/mm)	A	B	C	D	(Inch) E	F	J	K	L	Base W	Jaw Hole Space O	Weight Lbs.	Price(F)
3900-0170	3.15/80	3.15	3.15	0.94	3.15	1.97	0.87	1.22	0.44	8.27	3.18	1.77	18	233.25
3900-1719	3.94/100	3.94	4.15	1.26	4.05	2.36	1.14	1.34	1.44	10.43	3.97	2.50	23	315.12
3900-0171	4.92/125	4.92	5.10	1.57	3.93	2.52	1.47	1.42	0.55	11.85	4.96	2.99	40	368.32
3900-0172	6.30/160	6.30	7.32	1.73	5.51	3.03	1.65	1.93	0.75	15.39	6.33	3.88	64	495.20

MILLING VISES

TWIN - LOCK PRECISION CNC MILLING VISES -Self Centering

- Precision clamping force per jaw set.
- Precision ground on all sides, can be mounted vertically or horizontally.
- Bed hardened to RC 45 or higher to resist wear.
- Reversible hardened jaw plates for standard or, stepped part holding.
- Reduces the tool changes per job by 50%.
- Uses the same machine space as conventional vises limited to half the part holding capacity.
- Top mounted center block can be removed easily for larger parts application.



Data Without Center Jaw

Item#	Jaw Width	Inch		Wt. Lbs.
		A	B	
3900-1722	3.94/100mm	3.94	7.87	36
3900-0173	6.30/160mm	6.30	10.43	95

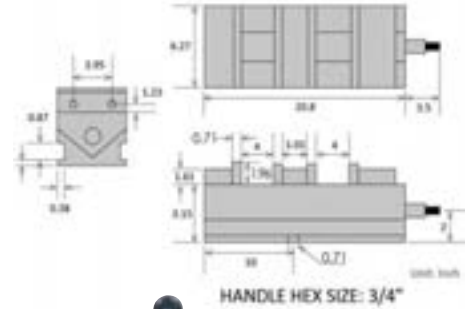

4" Jaw Width
3900-1722
\$481⁶⁸
 (F)
 Weight: 45 LBS.

Top Mount Removable Jaw

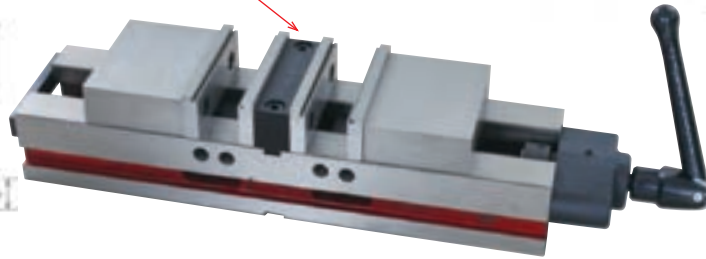
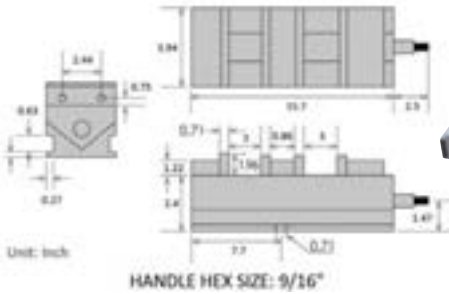
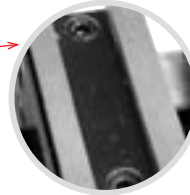

6" Jaw Width
3900-0173
\$756³¹
 (F)
 Weight: 109 LBS.

2PC QUICK CLAMP MILL VISES

- Work locates directly on bed for rigidity
- Mechanical type, actuated by Acme screw riding in bronze nut and guided by two H&G pins
- Quarter-turn handle clamps work firm enough for heaviest cuts
- Vise handle included

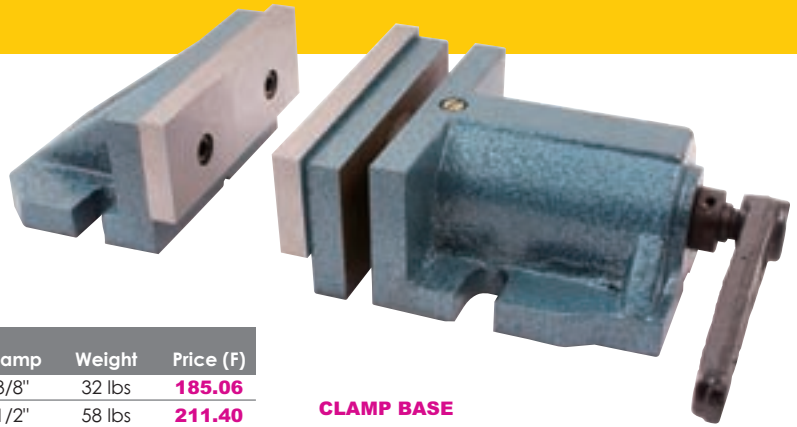

Item#	Jaw Width	Depth of Jaws	Key Slot Width	Min. T-Slot	Clamp	Weight	Price (F)
3900-1726	6"	3"	11/16"	2-1/4~2-3/4"	3/8"	32 lbs	185.06
3900-1728	8"	4"	13/16"	2-3/4~3-3/4"	1/2"	58 lbs	211.40

CLAMP BASE

2-WAY SWIVEL MOVEMENT ANGLE VISES

- Positive locking to withstand heavy loads.
- Horizontal swivel movement 360°.
- Vertical swivel movement 90°.
- Totally enclosed acme thread screw.
- Hardened and ground jaws.
- Vises supplied with plain jaws.
- Base T-slot width: 0.71"
- Vise handle included.

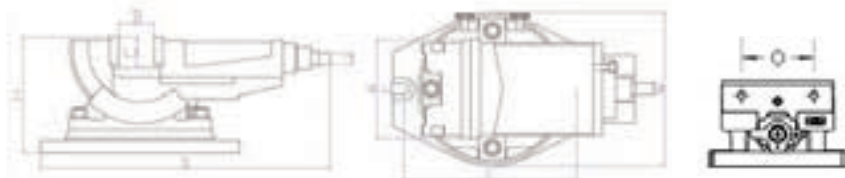

*Limited Supply

Item#	Jaw Width	Inch										Jaw Hole O	Weight Lbs.	Price (F)
		A	B	C	D	E	F	J	W	H				
3900-0018	3.94/100mm	3.94	3.15	1.69	15.55	0.55	8.78	0.55	7.24	6.18	2.36	54	294.68	
3900-0015*	4.92/125mm	4.92	3.94	1.81	18.89	0.55	9.96	0.67	8.78	6.73	3.15	61	409.27	
3900-0019	6.30/160mm	6.30	4.92	1.97	21.85	0.71	11.34	0.67	10.04	7.48	2.76	89	472.68	

CNC & MACHINE VISES

Pro-Series 3.98" SELF CENTERING CNC VISE

- Reversible Jaw: remove 4 screws to re-install jaws.
- Suitable for 4/5 axis CNC machines
- Repeat clamping tolerance +/- 0.0004"/ 0.01mm
- Material: FCD 60, high tension cast iron slide way has hardness of HRC 45.
- Interchangeable jaw heat treated to HRC 50.
- Lock down design to keep work piece from lifting.



MADE IN TAIWAN

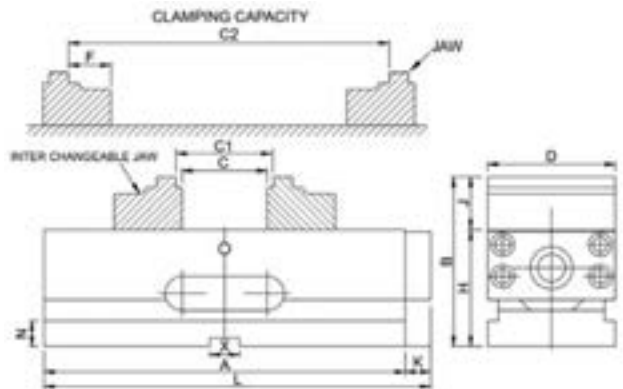

SELF-CENTERING

3900-2216
\$1,384⁴⁵_(F)

Jaw Width D	Jaw Depth J	Jaw Open C	Vise Height B	OAL L	Wt.	Max. Clamping C1	Clamping Range For C2	Max. Clamping Force	Torque For Clamping	A	F	H	K	N	X
3.98"	1.57"	5.20"	4.72"	10.24"	41 lbs	5.51"	2.44~7.56"	400 kgf	2.6m/kgf	9.45"	1.18"	3.15"	0.63"	0.83"	0.79"

Pro-Series 2.36" SELF CENTERING CNC VISE - With Swivel Base

- Suitable for 4/5 axis CNC machines
- Repeat clamping tolerance +/- 0.0004"/0.01mm
- Material: FCD 60, high tension cast iron slide way has hardness of HRC 450
- Interchangeable jaw heat treatment to HRC 55°.
- Lock down force to keep work piece from lifting.
- Swivel base 8" diameter x 22mm thickness
- Clamping Capacity: 1.77~5.51"



MADE IN TAIWAN

SWIVEL BASE INCLUDED

Item#	Jaw Width	Jaw Depth	Jaw Opening	Vise Height	OAL	Price (F)
3900-2220	2.36"	0.95"	3.94"	3.15 (w/o base)	7.3"	1,652.12

HORIZONTAL/VERTICLE MACHINE VISE - for Holding Shafts and Round Parts

- 4" wide hardened steel replaceable jaws.
- Capacity 3/8" to 2-1/2" round parts.
- Work rests on V-block made of hardened and ground tool steel.
- Adjustable sliding rod to set work in proper position.
- Vise ends are ground so that it can be used vertically or horizontally.

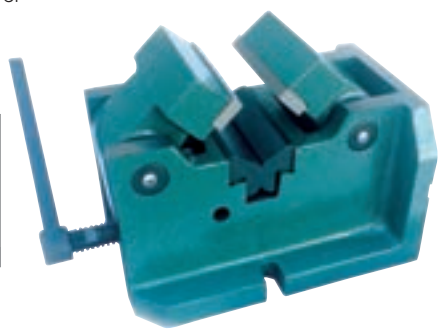

4 INCH
3900-1720
\$296⁴³_(F)
Weight: 50 Lbs.

Pro-Series MACHINIST'S STEEL VISE

- 360° swivel base or double lock down to keep stationary in any position.
- Self-centering, hardened steel pipe jaws, holds up to 6" pipe safely and securely.
- Straight line pull guaranteeing a lifetime spindle and nut.
- Cast steel body.

MADE IN TAIWAN



Item#	Jaw Width B	Jaw Opening A	(Inch) Height H	Min. OAL L	S	h	Weight (Lbs.)	Price (F)
3900-2511	6	5.9	7.2	16.5	9	3.1	31	252.12
3900-2513*	8	7.8	8.0	19.7	9.4	3.4	40	301.94

*Limited Supply

MACHINE TOOL ACCESSORIES

COMPOUND TABLES

5-1/2 X 12" COMPOUND SLIDE TABLE

- A heavy, rugged slide used in positioning, milling, drilling, microscope viewing and staging.
- Adjustable bases for heavy loads, small jig boring, precision cut-off.
- T-slot Width: 5/8"

3900-0027
\$20891
 (F)

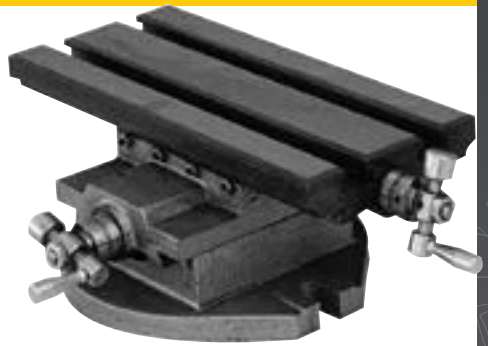
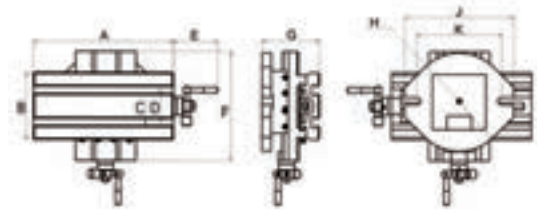

Unit: Inch

A	B	C	D	E	F	G	H	J	K	X Travel	Y Travel	Weight
12	5.5	5/8	2.5	3	9	4.5	8	9	7.6	8	5	40 Lbs.

6 x 18-1/2" COMPOUND MILLING TABLE

- Solid cast iron construction.
- Features 12" of longitudinal travel and 7-1/2" of transverse travel, adjustable gibs, dovetailed ways, dependable Acme screws, vernier scales and 9/16" T-slots.

3900-2728
\$59813
 (F)

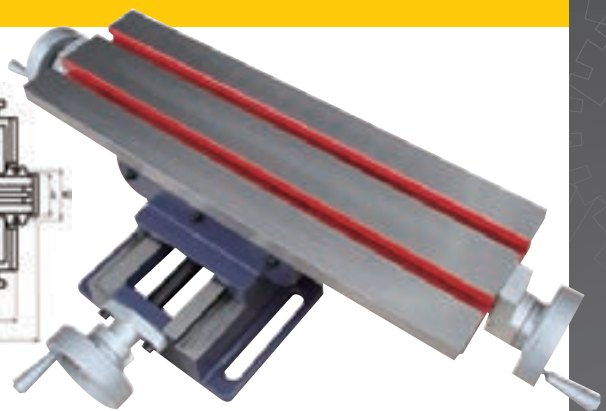
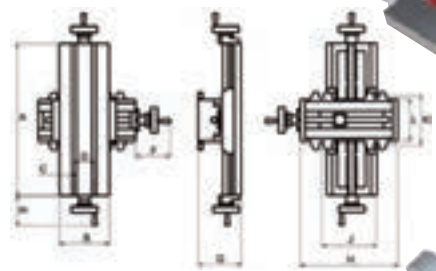

SPECIFICATIONS

Table Size.....	18-1/2 x 6"
Table Height.....	5-1/4"
Footprint.....	8 x 10-1/2"
T-Slot.....	9/16"
Mounting Slot.....	1/2" [2-1/4" on center]
Wt (lbs).....	58

Unit: mm

A	B	C	D	E	F	G	H	J	K	L	X Travel	Y Travel
473	156	14	62.5	94	108	134	305	170	152	130	270	120

5-1/2 x 12" COMPOUND SLIDE TABLE

- Heavy-duty compound slide table features 8" of longitudinal and 5" of transverse travel for versatile milling and drilling. Features 5-1/2" x 12" table, 5/8" slots, and adjustable gibs.

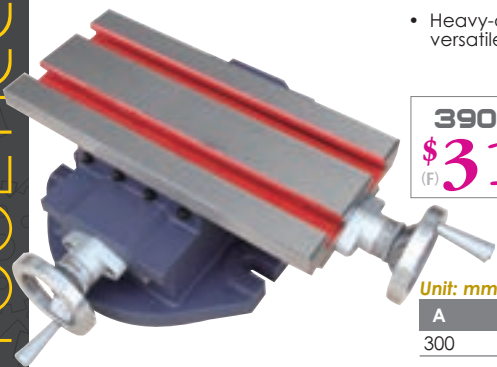

3900-2718
\$31746
 (F)

SPECIFICATIONS

Table Size.....	12x5-1/2"
Table Height.....	.5"
T-Slot.....	5/8"
Wt (lbs).....	.38

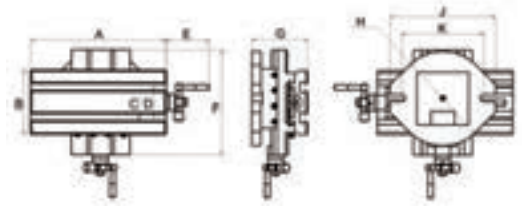

Unit: mm

A	B	C	D	E	F	G	H	J	K	X Travel	Y Travel	Weight
300	140	16	65	300	232	123	208	234	182	180	100	18kg

VERTICAL SLIDING MILLING/DRILLING TABLE

- 80mm up down travel distance.
- Solid cast iron construction.
- Table Size: 125 x 100mm/4.92 x 3.94"
- No. of T-slot: 3
- T-Slot Width: T-Slots is 9.8mm/0.386" wide at the top of the Tee, 16.5mm/0.65" wide at the bottom of the Tee.
- Easy to bolt on a mill table with 2 bolt holes (9mm/0.354" diameter).
- Weight: 11 lbs.

3906-2720
\$17160
 (F)

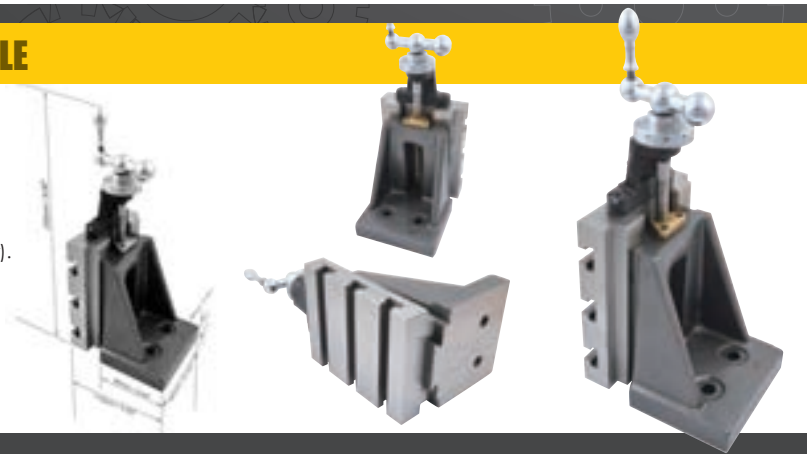

ANGLE, TILTING & ROTARY TABLES

SWIVEL ANGLE PLATES

- Adjustable range 0-90°.
- High grade casting with rugged construction.
- Machined "T" slots.
- 2-screw lock setting.
- Working surfaces are hardened and ground.



Item#	Size	Height	T-Slot	Wt. (Lbs)	Price (E)
3501-0014	6 x 8"	5"	1/2"	29	214.49
3501-0016*	8 x 10"	6"	9/16"	45	387.46
3501-0018*	10 x 12"	7"	5/8"	80	458.69

*Limited Supply

HEAVY DUTY TILTING TABLES

- Supplied complete with crank handle.
- Range 0-80° (40° each side).
- Has 2 screws for locked settings.
- Graduated in degrees for quick setting purposes.
- Heavy duty casting and precision ground with three T-slots.
- Set at any angle with indexer.
- Convex movement.



Item#	Size	Height	T-Slot	Wt. (Lbs)	Price (E)
3501-0001	7x5"	3-3/4"	1/2"	21	243.99
3501-0002*	10x7"	5"	1/2"	50	296.94
3501-0003*	15x10"	6-1/2"	1/2"	130	482.78

*Limited Supply

4" HORIZONTAL/VERTICAL ROTARY TABLE & DIVIDING PLATE

- 10 second vernier reading.
- One rotation of handle equals 4° on collar.
- Center height: 2.75"
- Gear ratio 72:1.
- Center Hole: 2MT
- Number of T-slot: 4



DIVIDING PLATE
3900-2400
\$ **216⁵⁵**
(E)

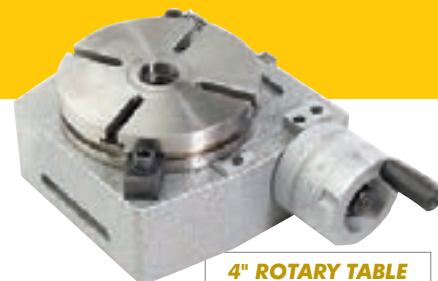

4" ROTARY TABLE
3900-2304
\$ **745⁰⁰**
(E)

SPECIFICATIONS	
Vernier Reading.....	10 seconds
Squareness	0.0008"
Base Parallelism (face to face).....	0.0004"
Taper (MT2) center bore Concentricity.....	0.0008"
Clamping surface flatness.....	0.0006"

- This set consists of one plate with a set of 10 holes. This allows you to divide a circle into 1/2 degree increments. You can divide a circle into the following number of divisions 2, 3, 4, 5, 6, 8, 9, 10, 12, 15, 16, 18, 20, 24, 30, 36, 40, 45, 48, 60, 72, 80, 90, 120, 144, 180, 240, 360, 720.

4" HORIZONTAL/VERTICAL ROTARY TABLE

- Table Diameter: 110mm/4-3/8".
- Horizontal Overall Height: 80mm/3-1/8"
- Vertical Overall Height: 152mm
- Overall Length (with handle): 280mm
- Center height: 86mm
- Gear ratio 90:1.
- Center Hole: 2MT
- T-Slot Width: 11mm/7/16"
- Number of T-slot: 3
- 10 second vernier reading.
- Graduated 360 degrees
- One rotation of handle equals 4° on collar.
- Worm gear is easily disengaged for free rotation.

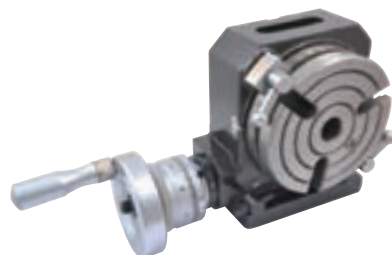

4" ROTARY TABLE
3906-2304
\$ **193⁰⁵**
(F)

100MM STEEL VISE - For 4" HORIZONTAL/VERTICAL ROTARY TABLE

- Made from tool steel
- Hardened and ground
- Low profile
- 4 mounting holes for easy attachment to rotary table.
- 4 mounting T-nut and cap screw included.
- V-groove for holding round parts.

3906-2214
\$ **50⁴⁹**
(F)

SPECIFICATIONS	
T-nut Width.....	7.6mm
Jaw Width.....	80mm
Jaw Depth.....	20mm
Jaw Opening.....	40mm
Base Diameter.....	100mm



MACHINE TOOL ACCESSORIES

ROTARY TABLES & ACCESSORIES

4" TILTING ROTARY TABLE

- Table Diameter: 100mm/3.94".
- Horizontal Overall Height: 70mm/2.76"
- Vertical Center Height: 70mm/2.76".
- Gear ratio 36:1.
- T-Slot Width: 7.95mm/5/16"
- Number of T-slot: 4
- 10 second vernier reading.
- One rotation of handle equals 10° on collar.
- Worm gear is easily disengaged for free rotation.
- Tilts 0~90°
- Base has two bolt holes: 9.8mm/0.386" diameter.



3906-2338

\$16175
(F)



HORIZONTAL & VERTICAL PRECISION ROTARY TABLES

- All rotary tables are precision ground.
- Low profile design .
- Worm gear is easily disengaged for free rotation.
- All rotary table parts are strategically positioned for easy access.

- The one piece worm and shaft were hobbled from a solid alloy steel.
- 10 second vernier reading.
- Graduated 360 degrees

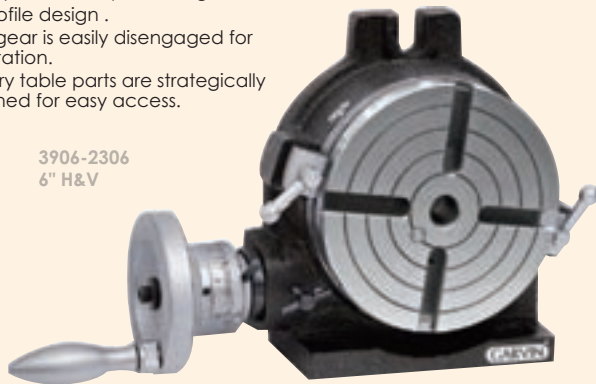

3906-2306
6" H&V

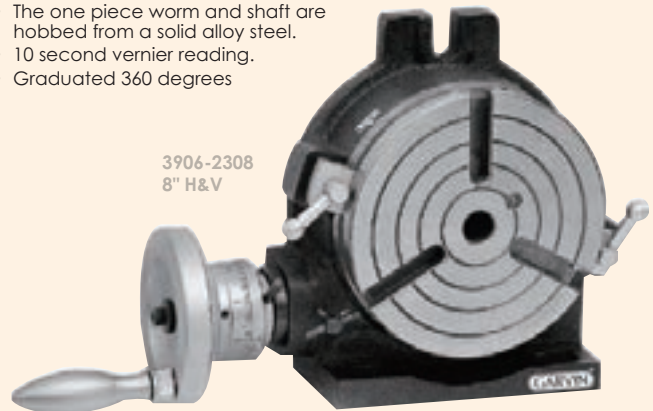

3906-2308
8" H&V

Item#	Table Size (Dia.)	Center Hole	(Inch) Center Height Vert	Horizontal Overall Height	Number of T-slots	T-slot Width	Weight (lbs.)	Price (F)
3906-2306	6"	2M.T.	4.02	3-1/4	4	0.63	31	284.21
3906-2308	8"	3M.T.	5.31	4-1/4	3	0.94	65	484.41

SPECIFICATIONS	VARIATION MAX.
CLAMPING SURFACE FLATNESS.....	0.0006"
CYLINDER CENTER BORE TIR.....	0.0008"
TAPER CENTER BORE TIR.....	0.0008"
SURFACE TO BASE PARALLELISM.....	0.0008"
SURFACE TO ANGLE FACE SQUARENESS.....	0.0004"
SURFACE TO CENTER SLOT SQUARENESS.....	0.0008"

DIVIDING PLATES - For 4~6" Rotary Tables

SET INCLUDES:

- Plate A - 15,16,17,18,19,20
- Plate B - 21,23,27,29,31,33
- Plate C - 37,39,41,43,47,49
- Washers,
- Crank Handle & Screws

3906-2390

\$6971
(F)

Fits Most of 4~6" Rotary Table



ADJUSTABLE TAILSTOCKS - For Rotary Tables



Fits 4~6" Rotary Table

3906-2406

\$7560
(F)

Fits 6~8" Rotary Table

3906-2407

\$8116
(F)

Item#	Fits Table	Adjustable Height (Min.~Max.)	Weight (lbs.)
3906-2406	4~6"	42~92mm/1.65~3.62"	6.2
3906-2407	6~8"	93~125mm/3.66~4.92"	22.5



ROTARY TABLES & ACCESSORIES

Pro-Series HORIZONTAL/VERTICAL ROTARY TABLES

- 10 second vernier reading.
- Gear ratio 90:1.
- One rotation of handle equals 4° on collar.

MADE IN TAIWAN

Unit: Inch

Item#	Table Size D	Height-over-all H	A	Center Hole	Center Height C	Number of T-slots	T-Slot Size	N	B	Weight (lbs.)	Price (E)
3900-2314	4.3"	2.8	5.4	2M.T.	3.3	3	.43	2.3	4.7	17	469.08
3900-2316	6"	3.1	8.1	2M.T.	3.9	3	.43	3.1	6.4	28	469.08
3900-2328	8"	4.1	10.4	3M.T.	5.3	3	.55	3.9	8.6	60	684.95
3900-2330	10"	4.5	12.6	3M.T.	6.5	6	.55	4.2	10.9	83	902.35
3900-2332	12"	5.3	15.3	4M.T.	7.7	6	.63	4.8	13.0	134	1,123.47

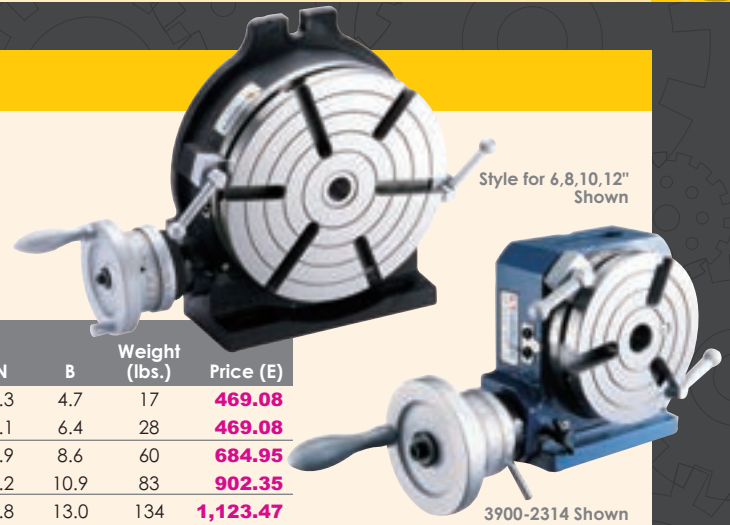

Pro-Series DIVIDING PLATES

MADE IN TAIWAN

- Suitable for Pro-Series rotary tables.
- Set includes: index plates, crank handle, 3pc screw, sector & U washer.

Item#	Fits Rotary Table (Dia.)	Plate Include	Price (E)
3900-2390	4 & 6"	SET I	145.30
3900-2392	8"	SET II	197.58
3900-2394	10 & 12"	SET II	197.58
3900-2396	6 & 8" (Super Spacer)	SET II	197.58

SET II

Plate A - 26, 30, 34, 38, 41, 44, 47, 51, 57, 28, 32, 37, 39, 43, 46, 49, 53, 59

Plate B - 62, 67, 71, 77, 81, 87, 91, 97, 63, 69, 73, 83, 89, 93, 99

SET I

Plate A - 15, 16, 17, 18, 19, 20

Plate B - 21, 23, 27, 29, 31, 33

Plate C - 37, 39, 41, 43, 47, 49



ADJUSTABLE TAILSTOCKS

Item#	Fits Table	Origin	Center Height	Price (E)
3900-2406	4"	China	2.75"	155.78
3900-2407	4-6"	Taiwan	3.2-4.3"	188.20
3900-2409	6 & 8"	Taiwan	4.5-5.7"	188.20
3900-2402	8 & 10"	China	5.5-7.5"	287.84
3900-2411	8, 10 & 12"	Taiwan	5.2-8.1"	190.95
3900-2403	12"	China	7.5-9.0"	280.56



FLANGES

- For front mount.
- For adapting a chuck to rotary table.
- Compatible with Pro-Series rotary tables, holes pattern may need to be modified for non Pro-Series.

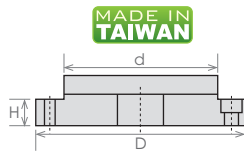

Item#	Fit Chuck Size	Used For Table (Dia.)	(Inch)			Price (E)
			D	d	H	
3900-2352	5	6 & 8	5.43	3.94	0.787	102.40
3900-2355	6	8 & 10	6.69	5.12	0.827	113.45
3900-2358*	7	10 & 12	7.68	6.10	0.945	127.28
3900-2360	8	12	8.27	6.30	0.945	127.28

* Limited Supply

3-JAW FRONT-MOUNT SELF-CENTER CHUCKS FOR ROTARY TABLES

- Plain back.
- Made of high quality steel.
- Hardened and ground.
- Lathe chuck wrench supplied.

TOP JAWS REVERSIBLE

Front mount chucks are designed to be used with rotary tables and other devices where back mounting chucks can not be used.

SQUARE & PARALLEL .0002"

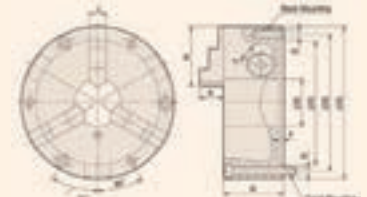

Item#	Chuck Size (Inch)		Center Hole		Mount Thread G		Price (F)	
	A	D	C	B	Front	Back		
3900-3430	6"	5.51	4.92	2.60	1.575	M8x70	M8x25	247.35
3900-3432	8"	6.93	6.30	3.00	2.559	M10x80	M10x30	326.00
3900-3434	10"	8.82	7.87	3.42	3.150	M12x85	M12x35	408.38
3900-3436	12"	11.26	10.24	3.86	3.937	M16x100	M16x40	801.14

ROTARY TABLES & INDEXERS

Pro-Series Low Profile HORIZONTAL & VERTICAL PRECISION ROTARY TABLES

- High precision bearing surfaces insure ultra-smooth rotation.
- Superior grade meehanite castings provide the ultimate rigidity.
- All rotary tables are precision ground to meet the most exacting requirements and are individually supplied with a certificate of inspection.
- The engraved graduations are both crisp and clear, eliminating erroneous readings.
- Low profile design minimizes machine capacity losses without sacrificing work load capacity.
- T-slots are machined within acceptable tolerances.
- Worm gear is easily disengaged for free rotation.
- Long life and continued accuracy is assured by a convenient adjustment to compensate for wear.
- All rotary table parts are strategically positioned for easy access.
- The one piece worm and shaft are hobbled from a solid alloy steel.
- Extra deep coolant channel
- 10 second vernier reading
- Dual positive action locks
- Graduated 360 degrees
- Gear drive immersed in oil
- 90:1 gear ratio



3903-2308

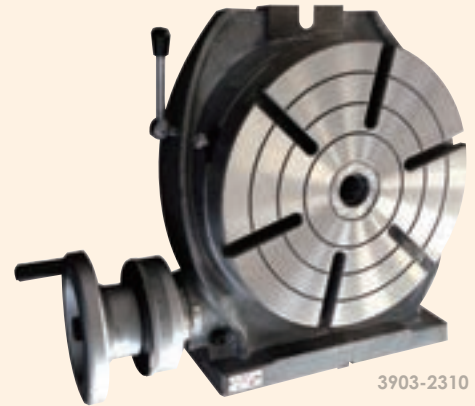

3903-2310

Limited Supply!

DIVIDING PLATES INTERCHANGEABLE WITH Phase II

Item#	Table Size (Dia.)	Center Hole	Center Height Vert (In.)	Number of T-slots	T-slot Width (In.)	Weight (lbs.)	Pricee (F)
3903-2308	8"	3M.T.	5.98	4	0.465	70	807.66
3903-2310	10"	3M.T.	6.75	6	0.465	102	986.15

SPECIFICATIONS	VARIATION MAX.
CLAMPING SURFACE FLATNESS.....	0.0006"
CYLINDER CENTER BORE TIR.....	0.0008"
TAPER CENTER BORE TIR.....	0.0008"
SURFACE TO BASE PARALLELISM.....	0.0008"
SURFACE TO ANGLE FACE SQUARENESS.....	0.0004"
SURFACE TO CENTER SLOT SQUARENESS.....	0.0008"

4" SUPER RAPID INDEXER

- Simple and rapid operation
- 4" 3-jaw chuck give a big range clamping capacity
- 24 position index (15° increments)
- 1° table scale for angle indexing
- Center hole 1.18" dia.
- Horizontal and vertical operation
- 2 sets of jaws (Internal & External).

MADE IN TAIWAN

4" Indexer
3900-2414
\$59280
(E)
Weight: 23 Lbs.

HHIP

100mm Indexer
3906-2414
\$43310
(E)
Weight: 22 Lbs.



VERTEX 5 INCH 3-JAW FREE ANGLE ROTARY CHUCK

- Easy & quick setting at any angle
- Four hex head bolts lock & secure chuck.
- 3-Jaw self centering chuck.
- 360° rotation, 30° tilting.
- Load Capacity: 33 lbs.
- 2 sets of solid jaws included (ID & OD).

MADE IN TAIWAN

3900-2350
\$98147
(F)

Locking With Hex Key (Included)

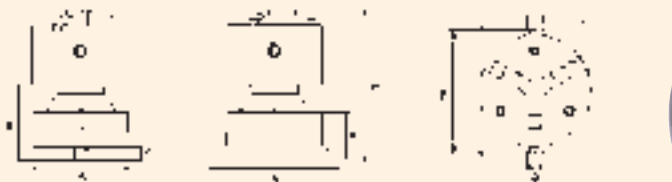

Chuck Jaw	O.D. Clamping Range	I.D. Clamping Range	A	B	C	D	E	F	G	H	Wt.
5"	0.12~4.33"	1.38~3.94"	5.51"	4.72"	0.79"	7.48"	2.83"	6.22"	0.67"	8.00"	38 lbs

PRECISION UNIVERSAL TILTING TABLE WITH SWIVEL BASE

- Heavy and sturdy machined construction.
- Range 45 degree each way from vertical.
- Keyway slot at bottom of swivel base: 0.485" position.
- Swivel base graduation 360 degree.
- Can be locked into position with 2 clamping screws on each end.
- 2 Machined "T" slots that are 0.31" width and precise ground table surface.

Table Size: 4x5"
3501-0030
\$50281
 (F)
 Weight: 13 Lbs.



Pro-Series UNIVERSAL TILTING ROTARY TABLES

- Highly rigid in the market
- Tilting 0-90° from horizontal to vertical position Lock setting with 2 screws
- 90:1 ratio worm is hardened and ground
- The work table is graduated a full 360° and micro collar is in steps of 2' min.

Tailstock and Dividing Plates are optional

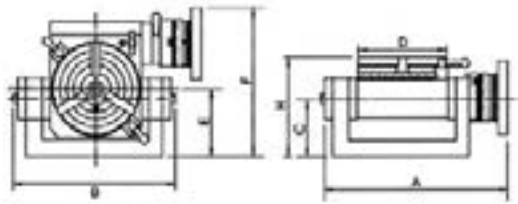

MADE IN TAIWAN

Unit: Inch

Item#	Table Size G	Height-Over-All H	Height-Over-All F	Center Hole	Center Height E	OAL A	B	C	Number of T-slots	T-Slot Size	Suitable Tailstock	Suitable Dividing Plate	Weight (lbs.)	Price (E)
3900-2338	4.3	4.61"	6.97"	2M.T.	3.15"	9.0	8.0	2.68	3	0.433	3900-2407	3900-2390	30	841.35
3900-2340	8	6.97"	11.14"	3M.T.	5.55"	16.9	17.0	4.37	3	0.551	3900-2411	3900-2392	110	1,162.38

TSK SERIES 10" TILTING ROTARY TABLE

- 10 second vernier reading.
- Gear ratio 90:1.
- Dual positive action locks
- Low profile
- gear drive immersed in oil
- maximum cumulative spacing error: 45 seconds

SPECIFICATIONS

Squareness (surface to angle face)0.0004"
Squareness (surface to center slot)0.0008"
Parallelism (surface to base)0.0008"
Cylindrical enter bore Concentricity0.0008"
Taper center bore Concentricity0.0008"
Clamping surface flatness0.0006"

3900-2315
\$2,721⁴⁰
 (E)
 Weight: 182 Lbs.

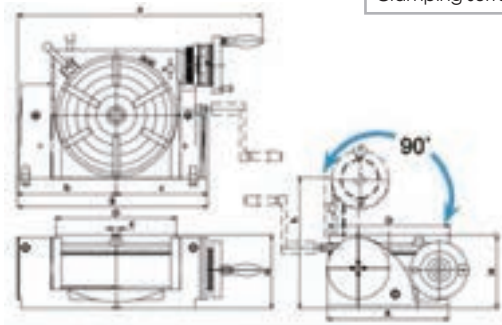

Table Dia.	Tilting Height	Range	Center Height	Hole	T-slot	Base
10"	8"	90°	5-1/2"	3MT	1/2"	10 x 12"

Pro-Series SUPER 6" & 8" ROTARY INDEXING FIXTURES

- Designed for milling, drilling, jig boring, and many other shop applications.
- Hardened and ground 24 position index plate (15° increments).
- 360° satin chrome graduated ring with 10 second adjustable vernier plate insures accurate readings.
- Each unit is equipped with 6 masking plates for fast and simple indexing of 2, 3, 4, 6, 8 and 12 divisions.
- Complete with 3-jaw chuck and faceplate.



FACE PLATE SHOWN



MADE IN TAIWAN

SPECIFICATIONS

Max. Individual Spacing Error.....	25 seconds
Vernier Reading.....	10 seconds
Squareness (table base to chuck 90°).....	0.0008"
Base Parallelism (face to face).....	0.0004"
Mounting Flange Concentricity.....	0.0008"
Chuck Concentricity.....	0.0005"

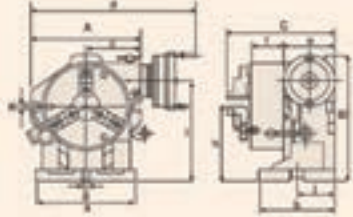

Unit: Inch

Item#	Table Size	Face Plate	Chuck Center Hole	A	B	C	a	b	d	e	f	g	Center Height h	i	j	k	Number of T-slots	T-Slot Size	Weight (lbs.)	Price (E)
3900-2318	6	8	1-23/32	9.84	9.37	8.15	7.17	5.5	16	4.41	2.6	.63	4.8	7.52	3.15	.63	6	0.433	98	1,278.63
3900-2321	8	10	2-15/32	12.6	11.57	9.27	9.06	6.3	19	4.99	3.0	.63	6.1	9.24	3.74	.79	6	0.551	177	1,783.64

Pro-Series ADJUSTABLE TAILSTOCKS -For 6&8" Rotary Indexing Fixture

Fits 6" Indexing Spacer
3900-2409
\$188²⁰
 (F)
 4.5 - 5.7" Center Height

Fits 8" Indexing Spacer
3900-2411
\$190⁹⁵
 (F)
 5.125 - 8.07" Center Height

MADE IN TAIWAN



Pro-Series DIVIDING PLATES -For 6&8" Rotary Indexing Fixture

- Suitable for Pro-Series rotary tables.
- Set includes: index plates, crank handle, 3pc screw, sector & U washer.

MADE IN TAIWAN



- SET INCLUDES:**
- Plate A** - 26, 30, 34, 38, 41, 44, 47, 51, 57, 28, 32, 37, 39, 43, 46, 49, 53, 59
- Plate B** - 62, 67, 71, 77, 81, 87, 91, 97, 63, 69, 73, 83, 89, 93, 99

Fits 6&8" Indexing Spacer
3900-2396
\$197⁵⁸
 (E)

Pro-Series REPLACEMENT PARTS -FOR 8" INDEXING FIXTURE (Vertex Brand)

MADE IN TAIWAN



Worm Metal
3900-2323
\$106¹⁸
 (E)

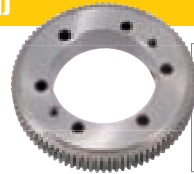

Worm Gear
3900-2324
\$89⁴⁹
 (E)

Pro-Series 8" 4 JAW ROTARY CHUCK-SELF CENTERING

MADE IN TAIWAN

- 360 degrees vernier scale: smooth swivel motion and easy locking by screws
- 2 sets of jaws



3900-2418
\$802⁹¹
 (F)

Unit: mm

A	A1	B	B1	D	E	F	H	I	J	K	M	Wt.
305	270	159	125	200	65	20	86	3-M10	75	34	18	67 lbs

Pro-Series 6" 3 JAW ROTARY CHUCK-SELF CENTERING

MADE IN TAIWAN

- 360 degrees vernier scale: smooth swivel motion and easy locking by screws
- 2 sets of jaws

3900-2416
\$592⁹³
 (F)



Unit: mm

A	A1	B	B1	D	E	F	H	I	J	K	M	Wt.
245	233	139	110	160	45	15	70	3-M8	69	29	14	40 lbs

Pro-Series SEMI - UNIVERSAL DIVIDING HEAD SETS

- Provides high accuracy with little backlash for a smooth rotation.
- Features easy indexing of divisions from 2 to 50 and most numbers up to 380.
- 3 dividing plates enable you to use different sizes (included).
- Adjustable tailstock allows you to work on various size workpieces (included).
- Ruggedly constructed of hardened and ground worm gear.
- Set also includes head, center and backplate for mounting 3-jaw chuck.



MADE IN TAIWAN

DIVIDING PLATE A B C

Numbers of Hole	Plate A	15	16	17	18	19	20
	Plate B	21	23	27	29	31	33
	Plate C	37	39	41	43	47	49

7-1/2" SWING
3800-5810
\$76670
(E)
Weight: 55 Lbs.

10" SWING
3800-5812
\$1,05473
(E)
Weight: 80 Lbs.

HIP PRO-SERIES

OPTIONAL FRONT-MOUNT 3-JAW CHUCKS

Chuck Size	Item#	Price (F)
4"	3800-5820	188.81
5"	3800-5821	215.38
6"	3800-5822	309.79

SPECIFICATIONS	ITEM 3800-5810	ITEM 3800-5812
Swing:	7-1/2"	10"
Center Height(h):	3-15/16"	5-3/64"
Hole Through Spindle(dia.):	0.709"	0.787"
Spindle Taper:	2MT	3MT
A/B/H	7.44"/5.52"/6.30"	11.34"/6.14"/8.66"
a/b	6.30"/3.58"	8.16"/4.48"
Optional 3-Jaw Chuck:	4"/5"	5"/6"
Tailstock Dimension:		
(A1xb1xH1)	6.6"x3.3"x4.3"	7.5"x4.3"x5.4"
a1/B1	5.13"/3.16"	5.91"/3.16"
g=g1	33/64"	5/8"

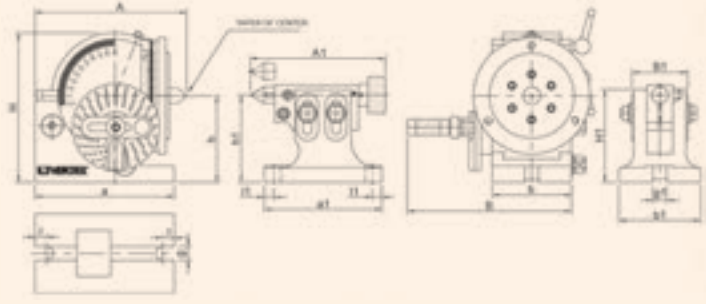

Pro-Series UNIVERSAL DIVIDING HEAD SET



HIP PRO-SERIES

10-1/2" SWING
3800-5815
\$1,88600
(E)
Weight: 180 Lbs.

MADE IN TAIWAN

- Ideal for easy indexing of divisions from 2 to 50 and most numbers from 52 to 380.
- Designed for all types of gear cutting.
- Worm and spindle are hardened and ground.
- Features spiral machining capability.
- Allows you to divide in any angle by the direct, indirect or differential methods with unique dividing head.
- Ratio between worm and worm gear: 40:1
- Features threaded spindle nose and 24 hole dividing plates with easy conversion to fast, direct indexing on numbers 2, 3, 4, 6, 8, 12, and 24.
- Complete set includes Dividing Head, Adjustable Tailstock, 3 Dividing Plates, 12 gears with 2 arms for differential indexing or transmitting machine table feed to worm shaft for spiral cutting.

DIVIDING PLATE A B C

Numbers of Hole	Plate A	15	16	17	18	19	20
	Plate B	21	23	27	29	31	33
	Plate C	37	39	41	43	47	49

MAX. VARIATION	
True Running Center:0.0006"
True Running of Inside Taper of Dividing Spindle Measured at Spindle Nose:0.0006"
Alignment of Dividing Head & Tailstock Vertical & Horizontal Plane:0.0008"

SPECIFICATIONS	
Swing:10-1/2"
Center Height (h):5.22"
Hole Through Spindle (dia.):0.945"
Spindle Taper:4MT
A/B/H:14.37" /10.71" /9.29"
a/b:8.39" /5.28"
Optional 3-Jaw Chuck:6"/8"
Tailstock Dimension (A1xb1xH1):10.0" x 4.9" x 5.5"
a1:6.89"
g=g1:0.63"

- OPTIONAL FRONT MOUNT CHUCKS**
6" 3-Jaw Chuck(Item #3800-5822)**\$309.79 (F)**
8" 3-Jaw Chuck(Item #3800-5823)**\$389.43 (F)**

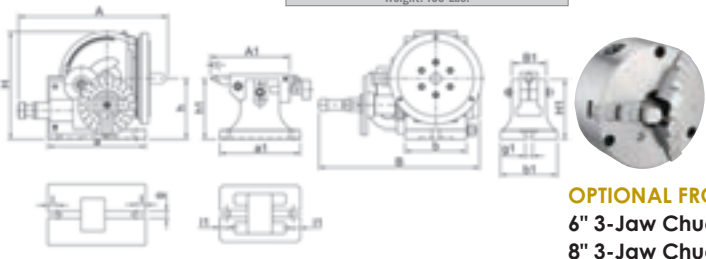

MACHINE TOOL ACCESSORIES

Pro-Series 10-1/2" SEMI-UNIVERSAL DIVIDING HEAD SET -WITHOUT CHANGING GEAR



HIP
PRO-SERIES

MADE IN
TAIWAN

- **Set Includes:**
A tail stock, a set of dividing plates, set of carrier clamps, 3-Jaw plate and center.

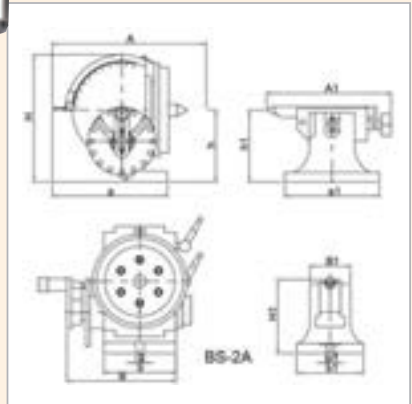

BS-2A
10-1/2" SWING
3800-5814
\$1,270⁴⁵
(E)
Weight: 106 Lbs.

- Vertex BS-2A 10-1/2" Semi-Universal Dividing Head Set.
- Hole through the spindle is 0.945"
- Spindle Taper is MT4
- Dividing head can divide in any angle by the direct, indirect or other methods.
- Feature easy indexing of divisions from 2 to 50 and most numbers up to 380
- Hardened and ground spindle is rigidly held in a taper roller bearing.
- Ruggedly constructed hardened and ground worm gear
- The swivel head can be locked at any angle from 10 degrees below horizontal to 90 degrees vertical allowing for a precision fit to the base assuring smooth rotation
- Provides high accuracy with little backlash for a smooth rotation
- The included adjustable tailstock allows you to work on various size workpieces
- Threaded spindle nose and 24 hole dividing plate provides easy conversion to fast direct indexing on numbers 2, 3, 4, 6, 8, 12 and 24
- The included dividing plates enable you to use different sizes
- Set also includes head, center, dog and backplate for mounting a 3-jaw chuck
- Optional front mount 3-jaw chucks that are available include a 6" #3800-5822 and a 8" #3800-5823

MAX. VARIATION

True Running Center:0.0006"
True Running of Inside Taper of Dividing Spindle Measured at Spindle Nose:0.0006"
Alignment of Dividing Head & Tailstock Vertical & Horizontal Plane:0.0008"

SPECIFICATIONS

Swing:10-1/2"
Center Height (h):5.22"
Hole Through Spindle (dia.):0.945"
Spindle Taper:MT4
A/B/H:11.22" /7.95" /9.33"
a/b:8.39" /5.28"
Optional 3-Jaw Chuck:6"/8"
Tailstock Dimension (A l x b l x H l):8.6" x 4.8" x 5.5"
a l:6.89"
g = g l:0.63"



- OPTIONAL FRONT MOUNT CHUCKS**
- **6" 3-Jaw Chuck** (Item #3800-5822).....**\$309.79 (F)**
Machine To Adapter Plate To Fit.
 - **8" 3-Jaw Chuck** (Item #3800-5823).....**\$389.43 (F)**
Fits on Dividing Head-No Machining Required.

DIVIDING PLATE A B C

Numbers of Hole	Plate A						Plate B						Plate C					
	15	16	17	18	19	20	21	23	27	29	31	33	37	39	41	43	47	49

Pro-Series 3-JAW FRONT-MOUNT SELF-CENTER CHUCKS, PLAIN BACK

- Easily mount on table, dividing head, fixture, or indexer.
- Lathe chuck wrench supplied.

MADE IN
TAIWAN

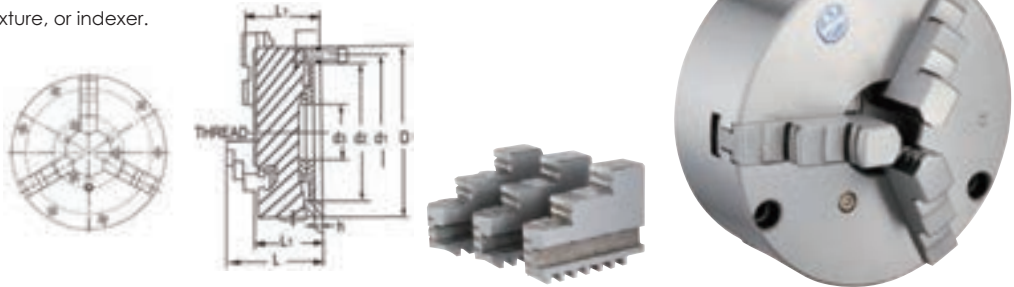

Front mount chucks are designed to be used with rotary tables dividing head and other devices where back mounting chucks can not be used.

Includes One Set of External Jaws & Internal Jaws

Item#	Chuck Size D (Inch/mm)	d1	(Inch) d2	Center Hole d3	L	L1	h	Thread Z-d	Gripping Range O.D. (mm)	I.D.(mm)	Price (F)
3800-5819	3/80	2.60	2.17	0.63	2.6	2.0	0.138	3-M6	2~70	24~64	179.97
3800-5820	4/100	3.31	2.83	0.87	2.9	2.2	0.138	3-M8	3~90	32~84	188.81
3800-5821	5/130	4.53	3.94	1.18	3.1	2.2	0.138	3-M8	3~110	35~100	215.38
3800-5822	6/160	5.59	5.12	1.77	3.7	2.6	0.197	3-M10	3~160	48~150	309.79
3800-5823	8/200	7.09	6.50	2.75	4.3	3.0	0.197	3-M12	4~180	56~170	389.43
3800-5824	10/250	8.86	8.11	3.15	4.7	3.2	0.197	3-M12	6~220	70~250	534.01

ER COLLET BLOCKS & FIXTURES

HEX / SQUARE ER COLLET BLOCKS

- Block Dimension: 1-3/4 x 1-3/4 x Height.
- For fast set-ups on CNC machines.
- For parallel, square or hex shapes as well as for cross hole drilling at 60°, 90° or 120°.
- Made of tool steel hardened and ground to .0005" flatness, squareness and parallelism.
- Through hole allows for long parts to be machined.
- May be used standing upright.
- Uses standard ER collets.
- ER nut included.



Item#	Shape	ER Collet	Block Height	Price (F)
3900-5123	Square	ER-25	2.7	43.11
3900-5124	Square	ER-32	2.8	42.10
3900-5125	Square	ER-40	3.2	45.95
3900-5127	Hex	ER-25	2.7	43.88
3900-5128	Hex	ER-32	2.8	43.11
3900-5129	Hex	ER-40	3.2	45.95

HEX & SQUARE COLLET BLOCK SET

- Capacity for standard 5C collets: 1/16" ~ 1-1/16".
- Overall Dimensions: 1-3/4" x 1-3/4" x 3-1/4".
- For fast set-ups on milling machines, lathes, surface grinders & drill presses.
- For parallel, square or hex shapes as well as for cross hole drilling at 60°, 90° or 120°.
- Made of tool steel hardened and ground to .0005" flatness, squareness and parallelism.

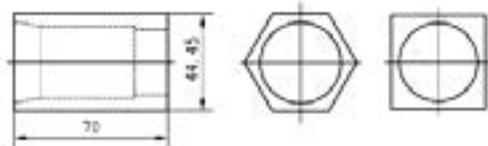

5 PC SET
3900-1620
\$7971
 (E)

5 PC INCLUDES:
 Square, Hex, Quick Acting Rings & Lever collet closer cam operated.

5C H/V ANGLE COLLET FIXTURE

- For any standard 5C collet
- Horizontal or vertical position.
- Lever movement to open or close collet.
- Base Size (horizontal): 5 x 4"
- Base Size (vertical): 5 x 3-5/8"
- Height (H/V): 3-5/8" / 4"

3900-1625
\$10175
 (F)



5C COLLET NOT INCLUDED



5C H/V COLLET FIXTURE

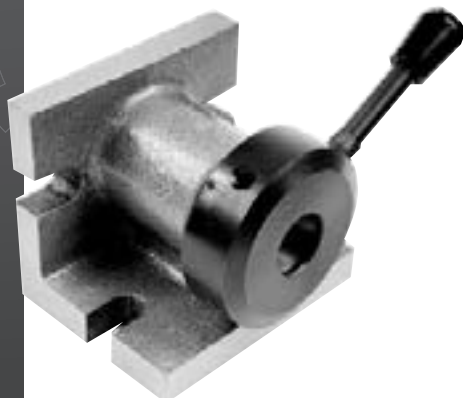

- For any standard 5C collet up to 1-1/8".
- Can be used in either horizontal or vertical position.
- Lever movement to open or close collet.
- Base Size: 4-1/4" x 4-1/4".
- Height: 4-1/4".
- Weight: 12 lbs

3900-1621
\$9050
 (E)

ANGLE END MILL GRINDING FIXTURE

- This fixture takes 5C round collets for grinding end mills 1/16" ~ 1-1/8" .
- Shell mills can easily be held with straight shank arbors.
- Solid negative ball stops with 15° spacing fast & easy set-ups.
- Can be used for grinding 2-3-4-6-8 and 12 flute end mills.
- Clearance & relief angles are built into the base.
- Solid 2-1/2" X 4-1/2" base bottom ground for sure contact.
- Black oxide finish.
- 5C collet not included.

3600-0056
\$8970
 (E)

5C COLLET NOT INCLUDED



COLLET INDEX FIXTURES

ER-32 PRECISION INDEXING SPIN JIG

- **Indexing and Grinding Fixture.**
- Uses ER-32 collets (range 1/16-13/16") for better gripping and accuracy.
- Extends the capabilities of Drill Presses, Surface Grinders, Gear Cutters and Milling Machines.
- Spindle hardened and ground with .0005" (T.I.R.) run-out.
- 10 vernier holes for 1° indexing.
- 2" spindle travel for flute grinding.
- 5" diameter index plate has 36 hole circle and graduated by 0 to 35 for direct indexing in 10° steps and is marked in 5° increments.
- Spindle lock for tightening collet.
- Base Footprint: 4.5x4" ground parallel to spindle.
- Weight: 14 lbs.

CENTER HEIGHT: 2.75"

3903-1600
\$ **143⁹⁰**
(F)

**NEW DESIGN
USES ER-32 COLLETS**



WRENCH INCLUDED

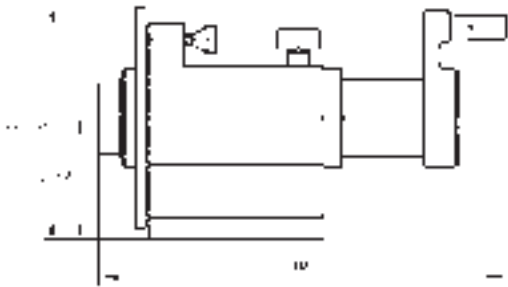

**ER COLLET
NOT INCLUDED**



OPTIONAL TAILSTOCK

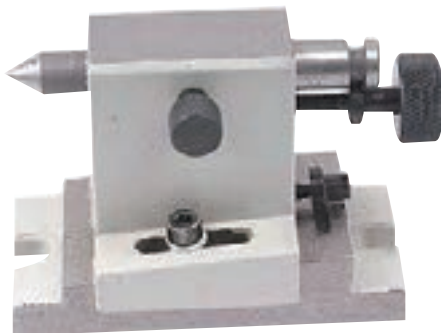

3900-2406
\$ **155⁷⁸**
(E)

OPTIONAL ER32 COLLET SETS



18 PC SET, INCH
3900-5267
\$ **181¹⁰**
(F)

3/32-3/4" BY 1/32

12 PC SET, METRIC
3903-5260
\$ **124³⁴**
(F)

3,4,5,6,8,10,12,14,15,16,18&20mm

HIGH PRECISION 5C INDEXING SPIN JIG

- Uses 5C Collets, 1 1/8" max. capacity. Extends the capabilities of Drill Presses, Surface Grinders, and Milling Machines. Vernier reads to 10 minute accuracy, .0004" ground lapped; 2" travel for flute grinding. Simple 1° indexing. Hardened and ground spindle. Index plate has 36 hole circle. Spindle run out within .0005"(T.I.R.). Spindle lock & hole for tightening collet. Plate graduated by 10 to 360.
- Index plate with 36 holes for direct indexing in 10° steps and is marked in 5° increments.
- Base size: 5x5"
- Weight: 20 lbs.

CENTER HEIGHT: 2.76"

3900-1604
\$9852
 (E)

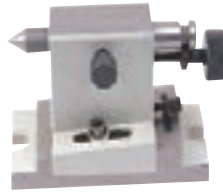
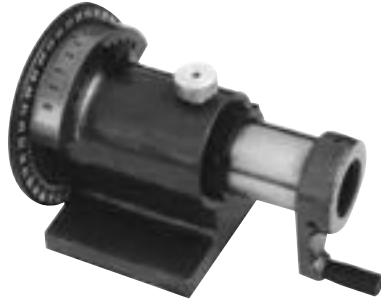

Optional Tailstock:
3900-2406.....\$155.78(E)

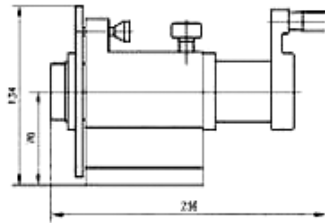

HIGH PRECISION 5C COLLET INDEXERS-Horizontal & Vertical

- Utilizes 5C collets.
- Spindle is manufactured with tapered seat in body frame.
- Lever operated collet closer with 100:1 leverage ratio.
- Front mounted ratchet control for rapid indexing.
- Index plate has 24 index locations (15° increments) that may be masked off for greater variety in applications).
- Single lever design.

DIVIDING SPINDLE CONCENTRICITY:
MAX. VARIATION .0002"

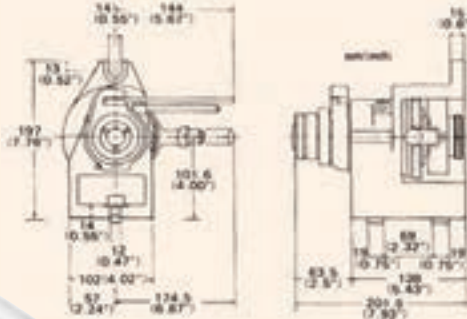
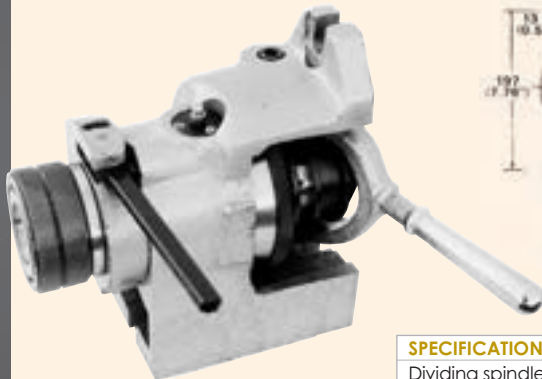

Threaded spindle is hardened and ground (2-1/4"-8 TPI)



Optional Tailstock
 (adjustable 4-6"):
3900-2407...\$188.20(E)

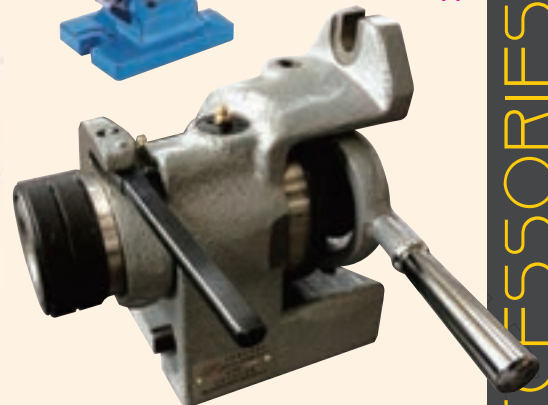

3900-1607
\$52900
 (E)

SPECIFICATIONS	VARIATION MAX.
Dividing spindle concentricity.....	0.0002"
Cylindrical center bore (per 1") concentricity.....	0.0008"
Spindle center line parallelism.....	0.0008"
Base to face squareness.....	0.0008"
Center slot to dividing spindle concentricity.....	0.0008"
Lateral offset of center slot to dividing spindle.....	0.0008"

Pro-Series Quality
3903-1607
\$56030
 (E)

Pro-Series PARTS
ARE INTERCHANGEABLE WITH PHASE II

5C EXPANDING COLLETS & SET

- Size Range: 0.250" - 1.937".
- Fits any standard 5-C spindle.
- Concentricity within .0005".
- Shoulder widths within .001".
- Effective expansion up to .006".
- Head : 1" length.
- Machinable.

EASILY MACHINED

4 PC SET
3900-1606
\$10673
 (E)
 INCLUDES: #1,2,3 & 4



INDIVIDUALS

Item#	Size	Price (E)
3900-1627	.250~.468" (#1)	26.58
3900-1628	.437~.800" (#2)	30.81
3900-1629	.750~1.437" (#3)	34.66
3900-1630	.750~1.937" (#4)	37.36

5C CLUTCH COLLETS-STEP

- One-piece construction
- Spring-tempered to allow easy workpiece loading and removal
- Easily machined
- Fits all 5C closers and fixtures
- 1-3/16" head thickness

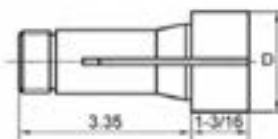

Item#	Size D	Price (F)
3900-1632	2"	30.81
3900-1633	3"	50.36
3900-1634	4"	71.59
3900-1635	5"	98.04
3900-1636*	6"	80.67

*Limited Supply



MACHINE TOOL ACCESSORIES

5C COLLETS & ACCESSORIES

30PC 5C COLLET RACK

- Baked enamel paint finish.
- Hangs on wall or machine, or sets on a shelf or work bench.

3900-1602
\$1914 (F)



HOLDS 30PC 5C COLLETS

FOOTPRINT: 12x9"

8PC COLLET RACK

- Holds 8 collets 5C, ER32 or others.
- Made from durable ABS material, heavy duty.
- Supplied with mounting hardware.
- 4 mounting holes: 3.5" and 5.5" apart.

3900-1609
\$1941 (F)



COLLETS NOT INCLUDED

5C COLLET STOP WITH TIPS-UNIVERSAL

- Speeding up repeat machining cycle.
- Includes: 5C Collet Stop, 2 Spring Ejector Tips & 2 Static tips.
- Tips size under 1/4" & 5/8" diameter.

3900-1616
\$1767 (F)



Unit: mm

HARLINGEN® HIGH PRECISION 5C COLLETS



- Clamping nose HRC55, body HRC40 and thread HRC25.
- Roughness Ra 0.4
- Internal and external thread machining after heat treatment reduces deformation, burrs and provides you with smooth threaded engagement.
- "STEP" Hardened and Ground Surface throughout protects the connection with spindle, also guarantees high accuracy, durability and long tool life.

Run-out accuracy
≤ 0.0006 INCHES at 3xD



MADE OF HIGH GRADE TOOL STEEL

5C ADJUSTABLE COLLET STOP

- Fully threaded adjustment screw.
- Thread size: 3/8" - 24.
- Fits collets with internal threads.

3900-1615
\$791 (F)



Unit: mm

5C COLLET WRENCH

- Simplifies insertion and removal of collets on the spindle noses of CNC turning machines.
- Steel head with comfort handle

3900-1617
\$2751 (F)



5C ER-32 COLLET CHUCK

- 5C-ER32 collet chuck Milling Chuck Holder.
- Made with DIN6499B (0.0005") Run-Out Tolerance.
- Holds all ER32 collets.
- Drawbar : 5C collet standard.
- Hardened and precision ground.
- Half-moon Spanner included.

3900-5099
\$8189 (F)



Item#	Size	Price (F)	Item#	Size	Price (F)
9742-3007	1/8"	13.96	9742-3031	1/2"	13.96
9742-3008	9/64"	13.96	9742-3032	33/64"	13.96
9742-3009	5/32"	13.96	9742-3033	17/32"	13.96
9742-3010	11/64"	13.96	9742-3034	35/64"	13.96
9742-3011	3/16"	13.96	9742-3035	9/16"	13.96
9742-3012	13/64"	13.96	9742-3036	37/64"	13.96
9742-3013	7/32"	13.96	9742-3037	19/32"	13.96
9742-3014	15/64"	13.96	9742-3038	39/64"	13.96
9742-3015	1/4"	13.96	9742-3039	5/8"	13.96
9742-3016	17/64"	13.96	9742-3040	41/64"	13.96
9742-3017	9/32"	13.96	9742-3041	21/32"	13.96
9742-3018	19/64"	13.96	9742-3042	43/64"	13.96
9742-3019	5/16"	13.96	9742-3043	11/16"	13.96
9742-3020	21/64"	13.96	9742-3044	45/64"	13.96
9742-3021	11/32"	13.96	9742-3045	23/32"	13.96
9742-3022	23/64"	13.96	9742-3046	47/64"	13.96
9742-3023	3/8"	13.96	9742-3047	3/4"	13.96
9742-3024	25/64"	13.96	9742-3048	49/64"	13.96
9742-3025	13/32"	13.96	9742-3049	25/32"	13.96
9742-3026	27/64"	13.96	9742-3050	51/64"	13.96
9742-3027	7/16"	13.96	9742-3051	13/16"	13.96
9742-3028	29/64"	13.96	9742-3052	53/64"	13.96
9742-3029	15/32"	13.96	9742-3053	27/32"	13.96
9742-3030	31/64"	13.96	9742-3054	55/64"	13.96

5C ROUND COLLETS & SETS

- Made of high grade tool steel.
- Hardened and precision ground.
- Internal and external threaded.

9 PC SET, Metric 3903-0012 \$7023 (F) 4 to 20mm by 2mm	14 PC SET, Metric 3903-0014 \$11796 (F) 12 to 25mm by 1mm	24 PC SET, Metric 3903-0016 \$20090 (F) 3 to 26mm by 1mm
---	--	---



6 PC SET, Inch 3900-0012 \$4932 (F) 1/8--3/4 by 8ths	17 PC SET, Inch 3900-0013 \$14093 (F) 1/16--1/16 by 16ths
---	--

33 PC SET, Inch 3900-0014 \$29552 (F) 1/16--1/16 by 32nds	69 PC SET, Inch 3900-1112 \$54902 (F) 1/16--1/8 by 64ths
--	---

Item#	Size (Inch)	Price (F)	Item#	Size(Inch)	Price (F)
3900-0011	1/16	11.84	3900-1136	39/64	9.36
3900-1101	5/64	11.84	3900-1137	5/8	9.36
3900-1102	3/32	11.84	3900-1138	41/64	9.36
3900-1103	7/64	11.84	3900-1139	21/32	9.36
3900-1104	1/8	9.36	3900-1140	43/64	9.36
3900-1105	9/64	9.36	3900-1141	11/16	9.36
3900-1106	5/32	9.36	3900-1142	45/64	9.36
3900-1107	11/64	9.36	3900-1143	23/32	9.36
3900-1108	3/16	9.36	3900-1144	47/64	9.36
3900-1109	13/64	9.36	3900-1145	3/4	9.36
3900-1110	7/32	9.36	3900-1146	49/64	9.36
3900-1111	15/64	9.36	3900-1147	25/32	9.36
3900-1113	1/4	9.36	3900-1148	51/64	9.36
3900-1114	17/64	9.36	3900-1149	13/16	9.36
3900-1115	9/32	9.36	3900-1150	53/64	9.36
3900-1116	19/64	9.36	3900-1151	27/32	9.36
3900-1117	5/16	9.36	3900-1152	55/64	9.36
3900-1118	21/64	9.36	3900-1153	7/8	9.36
3900-1119	11/32	9.36	3900-1154	57/64	9.36
3900-1120	23/64	9.36	3900-1155	29/32	9.36
3900-1121	3/8	9.36	3900-1156	59/64	9.36
3900-1122	25/64	9.36	3900-1157	15/16	9.36
3900-1123	13/32	9.36	3900-1158	61/64	9.36
3900-1124	27/64	9.36	3900-1159	31/32	9.36
3900-1125	7/16	9.36	3900-1160	63/64	9.36
3900-1126	29/64	9.36	3900-1161	1	12.00
3900-1127	15/32	9.36	3900-1162	1-1/64	12.00
3900-1128	31/64	9.36	3900-1163	1-1/32	12.00
3900-1129	1/2	9.36	3900-1164	1-3/64	12.00
3900-1130	33/64	9.36	3900-1165	1-1/16	12.00
3900-1131	17/32	9.36	3900-1166	1-5/64	12.00
3900-1132	35/64	9.36	3900-1167	1-3/32	12.00
3900-1133	9/16	9.36	3900-1168	1-7/64	12.00
3900-1134	37/64	9.36	3900-1169	1-1/8	12.00
3900-1135	19/32	9.36			

Pro-Series 5C ROUND COLLET SET

- **Guaranteed T.I.R: <0.0005"**.
- Made of high grade tool steel.
- Hardened and precision ground.
- Internal and external threaded.

HIP PRO-SERIES

15 PC SET
3900-1170
\$19938
 (F)
 1/8 ~ 1 by 16ths

5C EMERGENCY COLLETS

1/16"

Unit: mm

- Used for holding soft or delicate work pieces without marring surfaces.
- Internal and external threaded.

Item#	Material	Price (F)
3900-1611	Steel	15.31
3900-1612	Brass	36.31
3900-1613	Nylon	22.74

5C PRECISION SQUARE COLLETS

SQUARE

- Made of high grade tool steel.
- Hardened and precision ground.
- Internal and external threaded.

Item#	Size (Inch)	Price (F)
3900-1564	1/8	32.49
3900-1566	3/16	32.49
3900-1568	1/4	32.49
3900-1570	5/16	32.49
3900-1572	3/8	32.49
3900-1574	7/16	32.49
3900-1576	1/2	32.49
3900-1578	9/16	32.49
3900-1580	5/8	32.49
3900-1582	11/16	32.49
3900-1584	3/4	32.49

5C PRECISION HEX COLLETS

- Made of high grade tool steel.
- Hardened and precision ground.
- Internal and external threaded.

Item#	Size (Inch)	Price (F)
3900-1517	1/8	32.19
3900-1518	3/16	32.19
3900-1520	1/4	32.19
3900-1522	5/16	32.19
3900-1524	3/8	32.19
3900-1526	7/16	32.19
3900-1528	1/2	32.19
3900-1530	9/16	32.19
3900-1532	5/8	32.19
3900-1534	11/16	32.19
3900-1536	3/4	32.19
3900-1538	13/16	32.19
3900-1540	7/8	32.19

HEX

TOOL HOLDER BUSHINGS

TYPE C TOOL HOLDER BUSHINGS

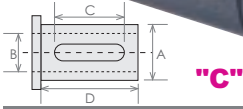
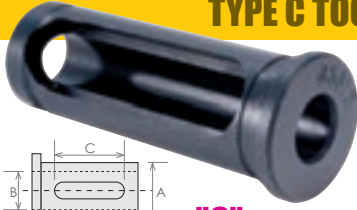

- Made of high quality tool steel.
- Tool Holder Bushing for universal use on all CNC turning machines to adapt a wide variety of boring bars, drills, reamers and shank type tools.
- Hardened and precision ground to highest concentricity.

Item#	A O.D.	B I.D.	C Slot Length	D	Price (F)
3900-1911		1/4			
3900-1912		5/16			
3900-1913	3/4"	3/8	1-7/8"	2-1/4"	32.19
3900-1914		1/2			
3900-1915		1/4			
3900-1916		5/16			
3900-1917	1"	3/8	2-3/8"	2-3/4"	40.17
3900-1918		1/2			
3900-1919		5/8			
3900-2910		3/4			
3900-2911		3/8			
3900-2912		1/2			
3900-2913		5/8			
3900-2914	1-1/4"	3/4	2-7/8"	3-1/4"	42.50
3900-2915		7/8			
3900-2916		1			
3900-2917		3/8			
3900-2918		1/2			
3900-2919		5/8			
3900-2920	1-1/2"	3/4	3"	3-3/8"	44.77
3900-2921		7/8			
3900-2922		1			
3900-2923		1-1/4			
3900-2924		1/2			
3900-2925		5/8			
3900-2926		3/4			
3900-2927	1-3/4"	7/8	3-1/8"	3-1/2"	59.70
3900-2928		1			
3900-2929		1-1/4			
3900-2930		1-1/2			
3900-2931		1/2			
3900-2932		5/8			
3900-2933		3/4			
3900-2938		7/8			
3900-2934	2"	1	3-5/8"	4"	62.25
3900-2935		1-1/4			
3900-2936		1-1/2			
3900-2937		1-3/4			

TYPE Z TOOL HOLDER BUSHINGS

- Made of high quality tool steel
- Tool Holder Bushing for all type of N/C-CNC turning centers, turret lathes and chucks
- The elongated slots give the user a complete interchangeability with all brands of equipment
- Hardened and precision ground to highest concentricity.

Limited Supply!

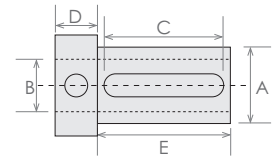

"Z"

Item#	A O.D.	B I.D.	C Slot Length	E	D	Price (F)
3900-3913		5/8				
3900-3915	1-1/4"	7/8	2-5/8"	3"	5/8"	20.68
3900-3921	1-1/2"	7/8	2-7/8"	3-1/4"	3/4"	23.72
3900-3924		1/2				
3900-3925		5/8				
3900-3926		3/4				
3900-3927	1-3/4"	7/8	3-1/8"	3-1/2"	3/4"	28.75
3900-3928		1				
3900-3929		1-1/4				
3900-3930		1-1/2				
3900-3931		1/2				
3900-3932		5/8				
3900-3934		7/8				
3900-3935	2"	1	3-3/8"	3-3/4"	3/4"	36.32
3900-3936		1-1/4				
3900-3938		1-3/4				

TYPE J TOOL HOLDER BUSHINGS

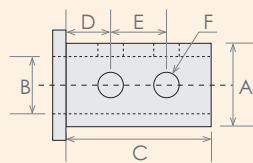

2- Holes
4- Holes

Limited Supply!

Item#	A O.D.	B I.D.	C	E	D	F	Price (F)
3900-1902	3/4"	5/16	1-1/2"	13/16"	3/8"	3/8"	13.11
3900-1905	1"	3/8	1-3/4"	7/8"	7/16"	5/8"	14.63
3900-1909		3/8					
3900-1910		1/2					
3900-4911	1-1/4"	5/8	2-1/8"	1"	5/8"	5/8"	16.65
3900-4913		7/8					
3900-4917		3/8					
3900-4918		1/2					
3900-4919	1-1/2"	5/8	2-1/2"	1-1/8"	11/16"	7/8"	17.67
3900-4921		7/8					

- Made of high quality tool steel Tool Holder.
- Hardened and precision ground to highest concentricity.
- Bushing has clearance holes so that you can clamp directly on the tool with set screws for positive alignment of the cutting edge of the tool.

Item#	A O.D.	B I.D.	C	E	D	F	Price (F)
3900-4924		1/2					
3900-4925		5/8					
3900-4926		3/4					
3900-4927	1-3/4"	7/8	3"	1-1/4"	3/4"	7/8"	26.25
3900-4928		1					
3900-4929		1-1/4					
3900-4930		1-1/2					
3900-4932		5/8					
3900-4933		3/4					
3900-4934	2"	7/8	3-1/2"	1-1/2"	3/4"	1"	31.26
3900-4936		1-1/4					
3900-4938		1-3/4					

EXPANDING ARBORS & MANDRELS

EXPANDING ARBORS & SET

OPERATION:

- Chuck arbor in machine to be used.
- Tighten expanding screw so that arbor expands .005".
- Machine arbor to length and size required.
- Loosen expanding screw.
- Position part on arbor and tighten expanding screw.

IMPROVED QUALITY

8 PC SET
3902-4006
\$72.09
 (F)

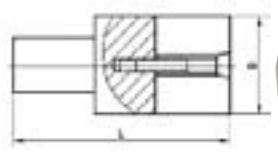

SET INCLUDES:

- (8) Sizes 1/4 to 1-1/4" arbors with alloy wrenches in a handy wooden stand.

INDIVIDUAL ARBORS

Item#	Size, D	Length, L	Price (F)
3902-4016	1/4"	3"	9.08
3902-4018	3/8"	3"	9.48
3902-4020	1/2"	3"	11.33
3902-4022	5/8"	3"	12.63
3902-4024	3/4"	4"	12.89
3902-4026	7/8"	4"	14.62
3902-4028	1"	4"	10.81
3902-4030	1-1/4"	4"	14.36

LATHE AND OD GRINDER MANDRELS

Designed For Setting-Up Accurately Bored Or Reamed Blanks And Castings

- Standard taper: .0005" per 1".
- Sizes under 1" are .0005" undersize on smaller end.
- Sizes 1-1/16" to 3" are .001" undersized on smaller end.
- Made of tool steel hardened and ground.

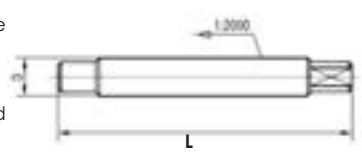

Unit: Inch

* Limited Supply

Dia. D	OAL L	Item#	Price (F)	Dia. D	OAL L	Item#	Price (F)	Dia. D	OAL L	Item#	Price (F)	Dia. D	OAL L	Item#	Price (F)
1/8	2-1/2	3902-2008	10.80	19/32	5-1/2	3902-2038	10.75	1-1/16	7-1/4	3902-2104	22.43	1-5/8	9-1/2	3902-2140	45.93
5/32	3	3902-2010	10.80	5/8	5-1/2	3902-2040	12.17	1-3/32	7-1/2	3902-2106	21.50	1-11/16	9-3/4	3902-2144	48.95
3/16	3	3902-2012	10.80	21/32	5-3/4	3902-2042	10.75	1-1/8	7-1/2	3902-2108	23.64	1-3/4	10	3902-2148	57.07
7/32	3-3/4	3902-2014	10.80	11/16	5-3/4	3902-2044	13.19	1-5/32	7-3/4	3902-2110	24.86	1-13/16	10-1/4	3902-2152	48.95
1/4	3-3/4	3902-2016	10.80	23/32	6	3902-2046	12.12	1-3/16	7-3/4	3902-2112	26.19	1-7/8	10-1/2	3902-2156	58.00
9/32	4	3902-2018	12.02	3/4	6	3902-2048	14.60	1-7/32	8	3902-2114	24.86	1-15/16	10-3/4	3902-2160	57.17
5/16	4	3902-2020	12.17	25/32	6-1/4	3902-2050	15.09	1-1/4	8	3902-2116	29.68	2	11	3902-2200	64.81
11/32	4-1/4	3902-2022	12.21	13/16	6-1/4	3902-2052	18.44	1-9/32	8-1/4	3902-2118	24.86	2-1/8	11-1/2	3902-2208	74.49
3/8	4-1/4	3902-2024	11.33	27/32	6-1/2	3902-2054	18.44	1-5/16	8-1/4	3902-2120	34.99	2-1/4	12	3902-2216	76.25
13/32	4-1/4	3902-2026	11.96	7/8	6-1/2	3902-2056	16.25	1-11/32	8-3/4	3902-2122	29.97	2-3/8	12	3902-2224	89.81
7/16	4-1/4	3902-2028	11.96	29/32	6-3/4	3902-2058	17.76	1-3/8	8-1/2	3902-2124	29.97	2-1/2	12-1/2	3902-2232	94.10
15/32	5	3902-2030	12.75	15/16	6-3/4	3902-2060	21.26	1-7/16	8-3/4	3902-2128	41.91	2-5/8	12-1/2	3902-2240*	57.24
1/2	5	3902-2032	12.17	31/32	7	3902-2062	17.76	1-15/32	9	3902-2130	35.32	2-3/4	13	3902-2248	124.36
17/32	5-1/4	3902-2034	12.56	1	7	3902-2100	21.26	1-1/2	9	3902-2132	41.84	2-7/8	13	3902-2256	92.11
9/16	5-1/4	3902-2036	12.75	1-1/32	7-1/4	3902-2102	21.17	1-9/16	9-1/4	3902-2136	40.48	3	13	3902-2300	121.05

EXPANDING MANDRELS & SETS

- Made of high grade tool steel
- Precision ground and heat treated for maximum concentricity and holding power.
- Center holes are ground and lapped.
- The automatic expansion feature can be utilized on any bore (standard or no-standard) within the range of the mandrel.
- Sizes up to 1" capacity are furnished with 1 sleeve; larger sizes are furnished with 2 sleeves (1 large and 1 small).
- Arbors are tapered, sleeves are flexible and size is obtained by moving sleeve along arbor.
- A range from 1/2" thru 2" by .0001" can be covered by a total of 8 mandrels.

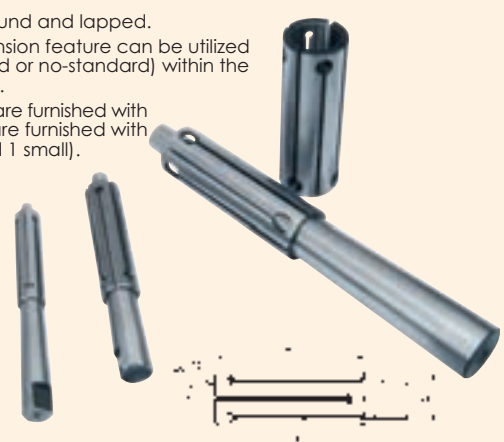

REPLACEMENT SLEEVES AVAILABLE!

EXPANDING MANDREL SETS

Item#	Size Range (D)	No. of Mandrels	Price (F)
3902-3070	1/2 ~ 1"	5	192.54
3902-3072	1 ~ 2"	3	234.95
3902-3074	1/2 ~ 2"	8	489.89
3902-3076	2~2-3/4"	3	372.01
3902-3078	2-3/4~3-3/4"	3	467.05

INDIVIDUAL EXPANDING MANDRELS

Item#	Size Range D	Length of Arbor (L)	Length of Sleeve (H)	Sleeves Furnished	Price (F)
3902-3050	1/2~9/16"	5"	2-1/2"	1	32.17
3902-3052	9/16~21/32"	6"	2-3/4"	1	33.31
3902-3054	21/32~3/4"	7"	2-3/4"	1	38.65
3902-3056	3/4~7/8"	7"	3-1/4"	1	42.96
3902-3058	7/8~1"	7"	3-1/4"	1	45.95
3902-3060	1~1-1/4"	9"	4"	2	95.85
3902-3062	1-1/4~1-1/2"	9"	4"	2	93.37
3902-3064	1-1/2~2"	11-1/2"	5"	2	109.22

MACHINE TOOL ACCESSORIES

LATHE CHUCK MOUNTING TYPES

American Standard "A" Series Spindle

- X Dimension refers to outside diameter of spindle nose.

Spindle	A5	A6	A7
X=	3-1/4	4-3/16	5-1/2
Spindle	A11	A15	A20
X=	7-3/4	11-1/4	16-1/4

Camlock "D" Series Spindle

- X Dimension refers to outside diameter of spindle nose.

Spindle	D1-3	D1-4	D1-5
X=	3-5/8	4-5/8	5-3/4
Spindle	D1-6	D1-8	D1-11
X=	7-1/8	8-7/8	11-3/4

Long Taper Key Drive "L" Series Spindle

- X Dimension refers to largest portion of taper.

Spindle	L00	L0	L1
X=	2-3/4	3-1/4	4-1/8
Spindle	L2	L3	
X=	5-1/4	6-1/2	

Threaded Series Spindle

- X Dimension refers to major diameter of thread.

X= Dia.(inch) - Pitch		
3/4-16	1-10	2-1/4-8
1/2-24	1-1/2-8	2-3/8-6
1/2-20	1-3/4-8	2-3/4-8
1-8		

BACK PLATE MOUNTING INSTRUCTIONS

Chuck Mounting Information: Using Semi-Finished Plates - For Standard Flat Back Lathe Chucks:

NOT for "Adjustable Run-Out" models (see separate instructions). When using a Chuck Adapter Plate to mount a flat back lathe chuck:

1. The lathe must be levelled with a precision level, this assures machining accuracy.
2. Adapter plate or chuck plate is to be mounted on lathe spindle.
3. A skim facing cut across the full face of the adaptor must be made. This assures that the face is at 90° to the centerline of the lathe spindle.
4. The chuck plate has a boss onto which the recess in back of the chuck must mount. Turn the boss to fit tightly into the chuck body. The accuracy of this operation is directly relative to best results.
5. Turn the O.D. of chuck plate to match the chuck - not always the same size of the chuck body, especially with 4 jaw independent chucks.
6. In most cases the chuck has threaded holes in the chuck body, to accept mounting bolts, or the chuck plate has threaded holes, for chucks having through holes in the body for front insertion. In some instances it may be necessary to transfer hole locations and drill clearance holes.
7. "A" type adaptors come in two versions: A-1 has two bolt circles (inner & outer), A-2 has a single outer bolt circle of tapped holes. The chuck adaptor is fastened to spindle separately, then the chuck is fastened to the plate.
8. Lathes having threaded spindle noses follow similar procedures 1 thru 6.

Chuck Mounting Information: Using Zero-Set Mounting Plates:

This type of chuck is designed so that the chuck body can be moved by utilizing adjusting screws. A ground pin is held firmly in the chuck mounted on the lathe. The pin is trammed with a test indicator and the adjusting screws used to correct the run-out. The design of the chuck adaptor permits the chuck adjusting screws to contact an extended boss on the plate, facilitating adjustment. These adaptors are to be "zeroed in" prior to actually mounting the chuck by taking a skim facing cut across the flange. All other dimensions should be compared to the back of the specific chuck and machined accordingly, if necessary. Once the mounted chuck has been "zeroed-in" in all respects, the chuck must be "locked" into the adjusted position. Double check with ground pin and test indicator.

LATHE CHUCK CLAMPING RANGE

Self-Centering Chucks

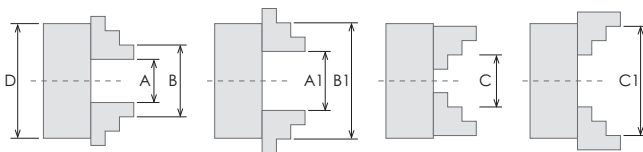

Chuck Size Inch/MM	Internal Jaw		External Jaw Clamping Range C-C1 (MM)
	Clamping Range A-A1 (MM)	Jamming Range B-B1 (MM)	
3/80	2-22	25-70	22-63
4/100	2-30	30-90	30-80
5/125	2.5-40	38-125	38-110
6/160	3-55	50-160	55-145
8/200	4-85	65-200	65-200
10/250	6-110	80-250	90-250
12/315	10-140	95-315	100-315
15/400	15-210	120-400	120-400
20/500	25-280	150-500	150-500

Independent Chucks

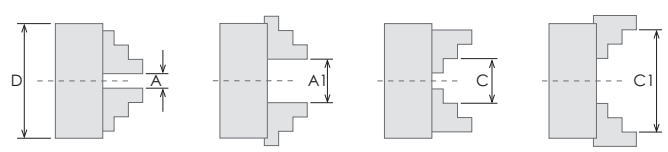

Chuck Size Inch/MM	Internal Jaw		External Jaw Clamping Range C-C1 (MM)
	Clamping Range A-A1 (MM)	Clamping Range A-A1 (MM)	
3/80	5-35		35-80
4/100	6-45		40-100
5/125	7-57		48-125
6/160	8-80		50-160
8/200	10-100		63-200
10/250	15-130		80-250
12/315	20-170		100-315
15/400	25-250		118-400
20/500	35-300		120-500

HARLINGEN® PREMIUM LATHE CHUCKS - ADVANTAGES

**Radial Runout
≤ 0.002 inches**



• CHUCK BODY

Body is entirely made of wear-resisting semi-steel No.40/No.45 (ASTM) providing a higher hardness at HB190-220 compared to other brands using HT250 cast iron with hardness of HB180-220.

• COVER PLATE

High quality No.35 (ASTM) is used to achieve a higher accuracy, strength and extended tool life. Competitors use HT150 cast iron or engineering plastics as a substitute.



• SOLID JAWS

Jaws are made of carbon 1045 (ASTM) steel and hardened. Pressed individually to ensure precise fit, powerful clamping performance and each jaw is interchangeable while maintaining accuracy.

• H-GROOVE

Specific machine and fixtures have been adopted to process H-Groove simultaneously so the clamping accuracy is guaranteed.



• PINIONS

Made of 20CrMnTi, quenching procedure to enhance wear-resistance and strength.



• SCROLL PLATE

Made of 5140 (ASTM) to enhance wear resistance and strength. Hardened and precision machined. Scroll face threads are processed with high accuracy CNC machining which improves self-centering performance.

• INSPECTION REPORT

Each chuck body has its own ID and 100% inspected with trackable data.



Clamping Range For Self-Centering Chucks

Size	Internal Jaws		External Jaws
	Clamping Range A-A1	Jamming Range B-B1	Clamping Range C-C1
3"	0.08"-0.87"	0.98"-2.76"	0.87"-2.48"
4"	0.08"-1.18"	1.18"-3.54"	1.18"-3.15"
5"	0.1"-1.57"	1.5"-4.92"	1.5"-4.33"
6"	0.12"-2.17"	1.97"-6.3"	2.17"-5.71"
8"	0.16"-3.35"	2.56"-7.87"	2.56"-7.87"

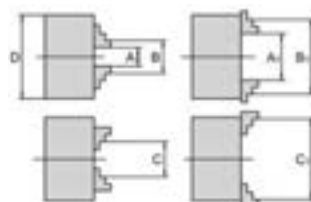

Clamping Range For Independent Chucks

Size	Internal Jaws	External Jaws
	Clamping Range A-A1	Clamping Range B-B1
3"	0.2"-1.38"	1.38"-3.15"
4"	0.24"-1.77"	1.57"-3.94"
5"	0.28"-2.24"	1.89"-4.92"
6"	0.31"-3.15"	1.97"-6.3"
8"	0.39"-3.94"	2.48"-7.87"

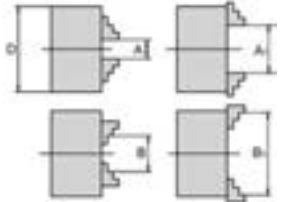

3-JAW PLAIN BACK LATHE CHUCKS

3-JAW SELF-CENTERING LATHE CHUCKS -PLAIN BACK

- Body made of high quality semi-steel.
- Hardened and ground.
- Lathe chuck wrench supplied.

PLAIN BACK



2 SETS OF HARD JAWS (INTERNAL AND EXTERNAL)
1 SET OF MOUNTING SCREWS INCLUDED

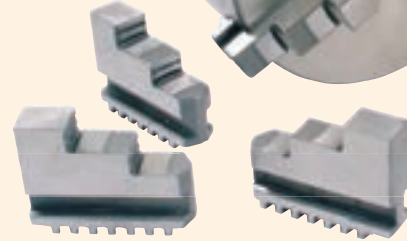
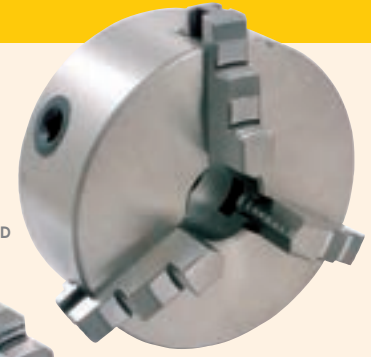

Item#	Size D	D1	(Inch) D2	h	H	Z-d	Center Hole	Max. RPM	T.I.R	Price (F)
3900-0031	3"	2.17	2.6	0.14	1.97	3-M6	0.630	4000	.003	126.36
3900-0032	4"	2.83	3.3	0.14	2.36	3-M8	0.866	3500	.003	135.58
3900-0033	5"	3.94	4.17	0.14	2.36	3-M8	1.181	3000	.003	158.46
3900-0035	6"	5.15	5.6	0.20	2.56	3-M8	1.575	2500	.003	221.82
3900-0037	8"	6.50	7.1	0.20	2.95	3-M10	2.559	2000	.004	275.00
3900-0038	10"	8.11	8.9	0.20	3.15	3-M12	2.756	1600	.004	392.70
3900-0040	12"	10.71	11.65	0.48	3.54	3-M16	3.937	1200	.005	722.15
3900-0039	15"	12.80	13.75	0.24	6.13	3-M16	5.709	1200	.005	985.60

Pro-Series 3-JAW FRONT-MOUNT SELF-CENTER CHUCKS -PLAIN BACK

- Easily mount on table, dividing head, fixture, or indexer.
- Lathe chuck wrench supplied.

HIP PRO-SERIES

MADE IN TAIWAN

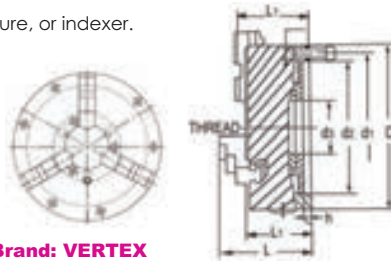

Front mount chucks are designed to be used with rotary tables dividing head and other devices where back mounting chucks can not be used.

Brand: VERTEX

Item#	Chuck Size D (Inch/mm)	d1	(Inch) d2	Center Hole d3	L	L1	h	Thread Z-d	Gripping Range O.D. (mm)	I.D.(mm)	Price (F)
3800-5819	3/80	2.60	2.17	0.63	2.6	2.0	0.138	3-M6	2~70	24~64	179.97
3800-5820	4/100	3.31	2.83	0.87	2.9	2.2	0.138	3-M8	3~90	32~84	188.81
3800-5821	5/130	4.53	3.94	1.18	3.1	2.2	0.138	3-M8	3~110	35~100	215.38
3800-5822	6/160	5.59	5.12	1.77	3.7	2.6	0.197	3-M10	3~160	48~150	309.79
3800-5823	8/200	7.09	6.50	2.75	4.3	3.0	0.197	3-M12	4~180	56~170	389.43
3800-5824	10/250	8.86	8.11	3.15	4.7	3.2	0.197	3-M12	6~220	70~250	534.01

With One Set of External Jaws & Internal Jaws

HARLINGEN® 3-JAW SELF-CENTERING LATHE CHUCKS -PLAIN BACK

- 2 sets of jaws
- Lathe chuck wrench and 1 set of mounting screws included

See page 284 for Advantages!

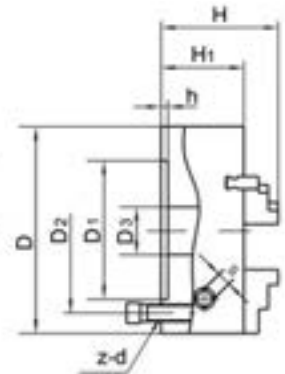
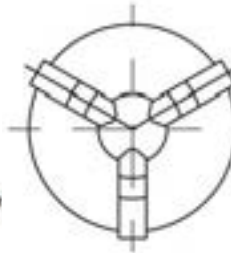

Item#	D	D1	D2	D3	H	H1	h	Wrench S	Screw	Max. Input Torque Nm	Max. Speed r/min	Weight (Lbs.)	Price (F)
9712-1105	3"	2.17"	2.6"	0.63"	2.6"	1.97"	0.14"	0.31"	3-M6	40	4000	4.2	133.41
9712-1106	4"	2.83"	3.3"	0.87"	2.93"	2.17"	0.14"	0.31"	3-M8	60	3500	7.1	144.27
9712-1107	5"	3.74"	4.25"	1.18"	3.3"	2.28"	0.16"	0.39"	3-M8	100	3000	11	163.35
9712-1108	6"	5.12"	5.6"	1.57"	3.74"	2.6"	0.2"	0.39"	3-M8	160	2500	19.4	236.66
9712-1109	8"	6.5"	7.09"	2.56"	4.29"	2.95"	0.2"	0.47"	3-M10	160	2000	34.2	290.68

3 & 6-JAW PLAIN BACK LATHE CHUCKS

3-JAW (TOP REVERSIBLE JAWS) SELF-CENTERING CHUCKS -PLAIN BACK



- Made of high quality steel.
- Hardened and ground.
- Lathe chuck wrench supplied.

TOP JAWS REVERSIBLE

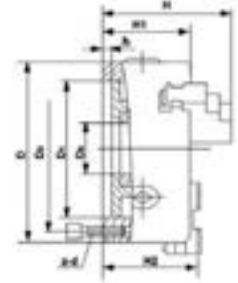

See page 289 & 290 for back plates

Item#	Size D	D1	D2	(Inch) h	A	Z-d	Center Hole	Max. RPM	T.I.R.	Price (E)
3900-3401	6"	5.12	5.60	0.20	2.5	3-M8	1.575	2500	.003	239.50
3900-3402	8"	6.50	7.09	0.20	3.0	3-M10	2.559	2000	.004	307.88
3900-3403	10"	8.10	8.90	0.20	3.3	3-M12	3.150	1600	.004	409.31
3900-3412	12"	10.70	11.66	0.24	4.2	3-M16	3.937	1200	.005	732.38
3900-3415	15"	12.80	13.78	0.24	4.3	3-M16	5.320	1000	.005	1,063.98
3900-3420	20"	17.32	18.31	0.24	5.0	6-M16	8.268	800	.006	2,068.33

3-JAW FRONT-MOUNT (TOP REVERSABLE JAWS) SELF-CENTERING CHUCKS -PLAIN BACK

- Easily mount on table, fixture, or indexer.
- Made of high quality steel.
- Hardened and ground.
- Lathe chuck wrench supplied.

SQUARE & PARALLEL .0002"



TOP JAWS REVERSIBLE



Front mount chucks are designed to be used with rotary tables and other devices where back mounting chucks can not be used.

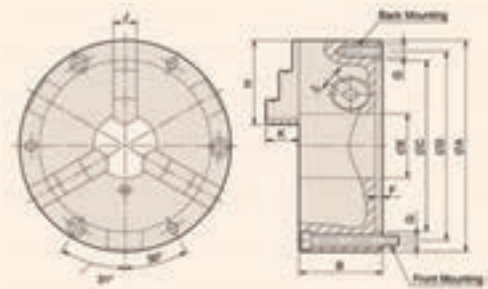

Item#	Chuck Size A	D	(Inch) C	B	Center Hole, E	G	Max. RPM	T.I.R.	Price (F)
3900-3430	6"	5.51	5.12	2.60	1.575	3-M8	2500	.003	247.35
3900-3432	8"	6.93	6.30	3.00	2.559	3-M10	2000	.004	326.00
3900-3434	10"	8.82	7.87	3.42	3.150	3-M12	1600	.004	408.38
3900-3436	12"	11.26	10.24	3.86	3.937	3-M16	1200	.005	801.14

6-JAW SELF-CENTERING LATHE CHUCKS -PLAIN BACK

- Excellent for holding and machining thin walled workpieces.
- Made of high grade semi-steel.
- Self centering jaws, hardened and precision ground.
- 1 set of mounting screws included.
- Adjusting wrench supplied.
- .003" T.I.R
- One set of internal solid jaws.

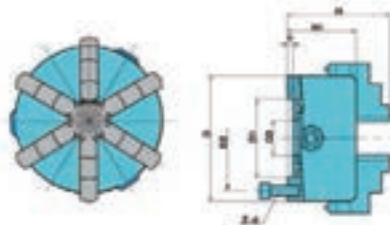

PLAIN BACK



*Limited Supply

Item#	Chuck Size	D	(INCH)		h	H1	H	Z-d	Center Hole D3	Max. RPM	CLAMPING RANGE Internal Jaws	External Jaws	Price (E)
3900-4550	4	4.4	3.15	3.74	0.14	2.30	4.1	3-M8	1.26	3500	2.0-30mm	30-80mm	341.27
3900-4552	5	5.1	3.94	4.53	0.14	2.40	3.4	3-M8	1.38	3000	4-40mm	40-130mm	242.93
3900-4555*	6	6.3	5.12	5.60	0.20	2.60	3.7	3-M8	1.77	2500	5-55mm	50-160mm	356.64
3900-4558*	8	7.9	6.50	7.09	0.20	3.00	4.3	3-M10	2.56	2000	6-85mm	65-200mm	364.73
3900-4559*	10	9.8	8.11	8.96	0.20	3.00	4.7	3-M12	3.15	1600	7.5-110mm	80-250mm	446.35

SELF CENTERING LATHE CHUCKS

4-JAW SELF-CENTERING SCROLL CHUCKS - PLAIN BACK

- Made of high grade tool steel.
- Universal scroll chucks.
- 2 sets of solid jaws included (ID & OD).
- Chuck wrench included.

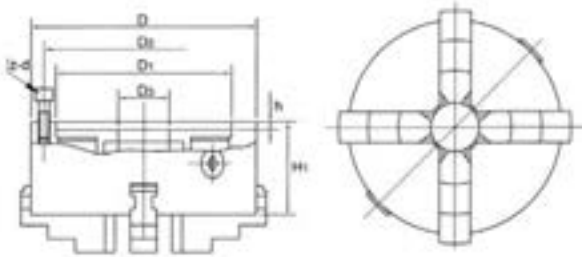

PLAIN BACK



Item#	Chuck Size D	D1	D2	(Inch) h	H1	H	Z-d	Center Hole D3	Max. RPM	T.I.R.	Price (F)
3900-0423	3	2.165	2.598	.14	1.97	2.6	3-M6	0.630	4000	.003	171.09
3900-0424	4	2.835	3.307	.14	2.17	3.0	3-M8	0.866	3500	.003	178.59
3900-0425	5	3.740	4.252	.16	2.28	3.3	3-M8	1.181	3000	.003	200.60
3900-0426	6	5.118	5.591	.20	2.56	3.8	3-M8	1.772	3000	.003	270.18
3900-0428	8	6.495	7.087	.20	2.95	4.5	3-M10	2.559	2000	.004	403.68
3900-0430	10	8.110	8.898	.20	3.54	4.9	3-M12	3.150	1600	.005	447.23
3900-0432	12	10.236	11.220	.24	3.74	5.6	3-M16	3.937	1200	.005	879.26

HARLINGEN® 4-JAW SELF-CENTERING LATHE CHUCKS -PLAIN BACK



- 2 SETS OF JAWS (ID & OD)
- LATHE CHUCK WRENCH AND 1 SET OF MOUNTING SCREWS INCLUDED

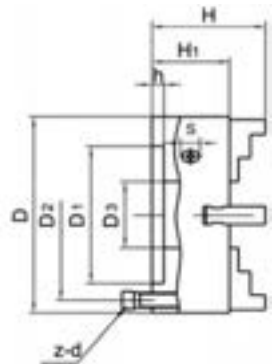
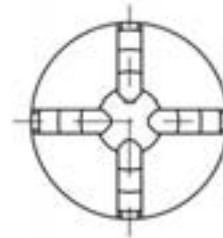

See page 284 for Advantages!

Item#	D	D1	D2	D3	H	H1	h	Wrench S	Screw	Weight (Lbs.)	Price (F)
9713-2110	3"	2.17"	2.6"	0.63"	2.6"	1.97"	0.14"	0.31"	3-M6	4.4	249.62
9713-2101	4"	2.83"	3.31"	0.87"	2.87"	2.11"	0.14"	0.31"	3-M8	6.6	249.62
9713-2102	5"	3.74"	4.25"	1.18"	3.31"	2.28"	0.16"	0.39"	3-M8	11	282.49
9713-2103	6"	5.12"	5.59"	1.57"	3.74"	2.56"	0.20"	0.39"	3-M8	19.4	388.08

5C MOUNT SELF-CENTERING 3 & 4-JAW LATHE CHUCKS

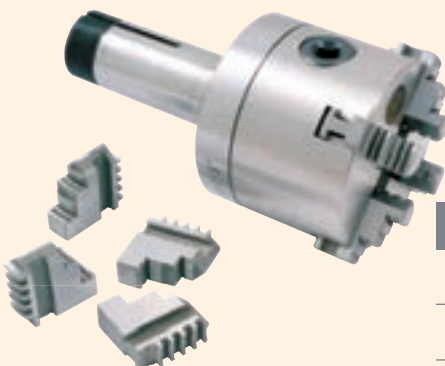

- Quick set up in fixtures and 5C spindles.
- Supplied with chuck wrench.
- T.I.R. 0.0006".
- Chuck jaws are self centering, scroll type.
- 5C adapter with standard internal and external threads.

2 SETS OF SOLID STEEL JAWS (INTERNAL AND EXTERNAL)

Item#	Chuck Size	Jaw	Price (E)
3900-4701	3"	3-Jaw	158.06
3900-4710	3"	4-Jaw	211.73
3900-4702	4"	3-Jaw	195.94
3900-4711	4"	4-Jaw	219.71

SPECIFICATION	Chuck Size	Outside Diameter (Clamp Range)	Inside Diameter (Jam Range)	Hole thru. 5C Adapter	Hole thru. Chuck
3-JAW	3"	0.079~2.480"	0.964~2.756"	0.75"	0.630"
	4"	0.079~3.150"	1.181~3.543"	0.75"	0.866"
4-JAW	3"	.062~2.50"	.700~2.50"	0.75"	0.800"
	4"	.062~3.00"	.900~3.50"	0.75"	0.950"

4-JAW INDEPENDENT LATHE CHUCKS

4-JAW INDEPENDENT LATHE CHUCKS -PLAIN BACK



PLAIN BACK



- Body made of high quality semi-steel.
- Hardened and ground.
- 1 set of mounting screws included.
- Reversible individual adjusting jaws.
- Adjusting wrench supplied.



Designed to grip round or odd shaped work.

Item#	Size D	D1	D2	(Inch) h	H	Z-d	Center Hole	Price (F)
3900-0413	3"	2.17	2.60	0.12	1.65	3-M6	0.630	121.66
3900-0414	4"	2.83	3.30	0.14	2.13	4-M8	0.866	133.20
3900-0415	5"	3.74	4.25	0.18	2.21	4-M8	1.180	159.87
3900-0041	6"	2.56	3.74	0.20	2.56	4-M10	1.772	182.75
3900-0042	8"	3.15	4.41	0.24	2.95	4-M10	2.205	234.68
3900-0043	10"	4.33	5.12	0.24	3.15	4-M12	3.150	305.93
3900-0046	12"	5.51	6.50	0.24	3.54	4-M16	3.543	575.08
3900-0048	16"	7.87	8.94	0.39	4.13	4-M16	3.937	879.45

HARLINGEN® 4-JAW INDEPENDENT LATHE CHUCKS -PLAIN BACK



6 & 8" SHOWN

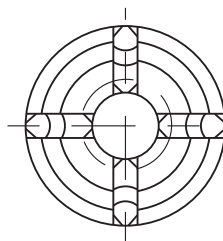

D=3,4&5"

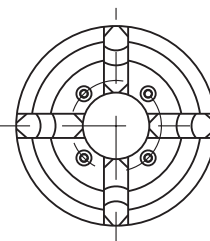

D=6&8"

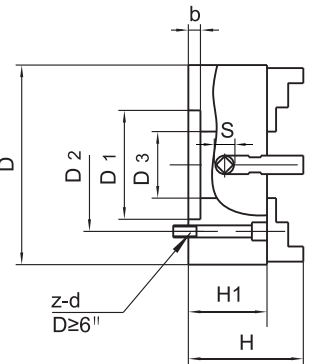

- Reversible jaws
- Lathe chuck wrench and 1 Set of mounting screws included

See page 284 for Advantages!

6&8" chucks are provided with thru-hole for easily mounting on table, dividing head, fixture, or indexer.

Item#	D	D1	D2	D3	H	H1	h	Wrench S	Screw	Max. Input Torque Nm	Max. Speed r/min	Weight (Lbs.)	Price (E)
9713-1101	3"	2.17"	2.6"	0.87"	2.2"	1.65"	0.14"	0.31"	4-M6	25	4000	5.5	190.53
9713-1102	4"	2.83"	3.30"	0.98"	2.13"	2.91"	0.14"	0.31"	4-M8	30	3500	6.6	182.90
9713-1103	5"	3.74"	4.25"	1.18"	3.07"	2.2"	0.18"	0.39"	4-M8	50	3000	11	204.62
9713-1104	6"	2.56"	3.74"	1.77"	3.66"	2.56"	0.2"	0.39"	4-M10	70	2500	19.8	215.26
9713-1105	8"	3.15"	4.41"	2.2"	4.21"	2.95"	0.24"	0.47"	4-M10	100	2000	33	267.79

5C 4-JAW INDEPENDENT LATHE CHUCKS

- Quick set up in fixtures and 5C spindles.
- Supplied with 1 set of reversible jaws.
- T.I.R. 0.0006".
- 5C adapter with standard internal and external threads.
- Supplied with chuck wrench.

3", 4 JAW
3900-4712
\$ **17633**
(E)

4", 4 JAW
3900-4713
\$ **17988**
(E)

Chuck Size	Outside Diameter (Clamp Range)	Inside Diameter (Jam Range)	Hole thru. 5C Adapter	Hole thru. Chuck
3"	.062~2.50"	.700~2.50"	0.75"	0.63"
4"	.062~3.00"	.900~3.50"	0.75"	0.86"

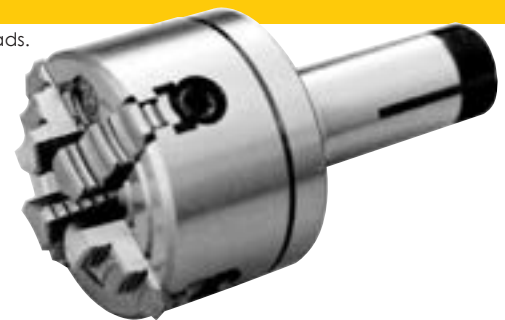

BACK PLATES

THREADED BACKPLATES FOR LATHE CHUCKS -With Bolt HOLE

- Fits most plain back chucks.
- Made of high grade casting steel.
- Assembly instructions included.

THREADED MOUNT



For 3-Jaw Chucks

Item#	Chuck Size D	Price (F)
3900-3107	3	33.63
3900-3108	3	33.63
3900-3109	3	33.63
3900-3110	3	33.63
3900-3111	3	33.63
3900-3112	3	33.63
3900-3210	4	38.94
3900-3211	4	38.94
3900-3212	4	38.94
3900-3215	4	38.94

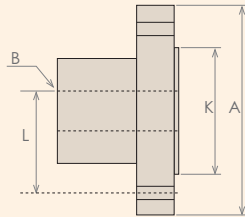

For 4-Jaw Chucks

Item#	Chuck Size D	Price (F)
3900-4129	3	33.63
3900-4130	3	33.63
3900-4131	3	33.63
3900-4132	3	33.63
3900-4133	3	33.63
3900-4141	4	38.94
3900-4142	4	38.94
3900-4143	4	38.94

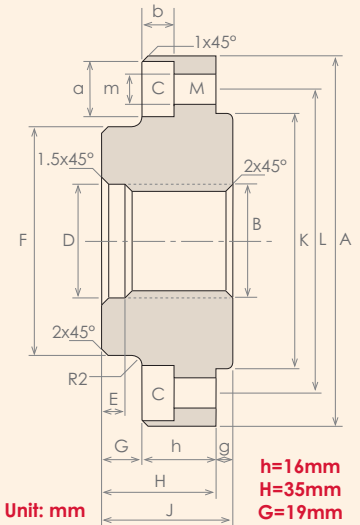

Unit: mm

Item#	Chuck Size	Body Diameter A	Thread B	Bolt Hole C	Reg Dia D	Reg Len E	Hub Dia F	Boss Len g	All Len J (g+H)	Boss Dia K (mm/Inch)	Bolt Cir L (mm/Inch)	Bolt M	a	b	m
3900-3107	3"	80	3/4"~16	3	3/4"	4	50	3	38	55.5/2.2	66/2.6	M6	12	8	6.5
3900-3108	3"	80	1/2"~24	3	1/2"	4	50	3	38	55.5/2.2	66/2.6	M6	12	8	6.5
3900-3109	3"	80	1/2"~20	3	1/2"	4	50	3	38	55.5/2.2	66/2.6	M6	12	8	6.5
3900-3110	3"	80	1"~8	3	1"	5	50	3	38	55.5/2.2	66/2.6	M6	12	8	6.5
3900-3111	3"	80	1"~10	3	1"	5	50	3	38	55.5/2.2	66/2.6	M6	12	8	6.5
3900-3112	3"	80	1-1/2"~8	3	1-1/2"	6	50	3	38	55.5/2.2	66/2.6	M6	12	8	6.5
3900-4129	3"	80	1/2"~20	4	1/2"	4	50	3	38	55.5/2.2	66/2.6	M6	12	8	6.5
3900-4130	3"	80	3/4"~16	4	3/4"	4	50	3	38	55.5/2.2	66/2.6	M6	12	8	6.5
3900-4131	3"	80	1"~8	4	1"	5	50	3	38	55.5/2.2	66/2.6	M6	12	8	6.5
3900-4132	3"	80	1"~10	4	1"	5	50	3	38	55.5/2.2	66/2.6	M6	12	8	6.5
3900-4133	3"	80	1-1/2"~8	4	1-1/2"	6	50	3	38	55.5/2.2	66/2.6	M6	12	8	6.5
3900-3210	4"	100	1"~10	3	1"	5	66	3.5	38.5	72.5/2.9	84/3.3	M8	14	9	8.5
3900-3211	4"	100	1"~10	3	1"	5	66	3.5	38.5	72.5/2.9	84/3.3	M8	14	9	8.5
3900-3212	4"	100	1-1/2"~8	3	1-1/2"	6	66	3.5	38.5	72.5/2.9	84/3.3	M8	14	9	8.5
3900-4141	4"	100	1"~8	4	1"	5	66	3.5	38.5	72.5/2.9	84/3.3	M8	14	9	8.5
3900-4142	4"	100	1"~10	4	1"	5	66	3.5	38.5	72.5/2.9	84/3.3	M8	14	9	8.5
3900-4143	4"	100	1-1/2"~8	4	1-1/2"	6	66	3.5	38.5	72.5/2.9	84/3.3	M8	14	9	8.5
3900-3215	4"	100	M39x4	3	1-1/2"	5	66	3.5	38.5	72.5/2.9	84/3.3	M8	14	9	8.5

THREADED & BLANK BACKPLATES FOR LATHE CHUCKS -NO BOLT HOLE

- Made of high grade casting steel.

NO BOLT HOLE BACKPLATES MACHINING REQUIRED BEFORE MOUNTING TO ENSURE CONCENTRICITY



For 3&4-Jaw Chucks

Item#	Chuck Size D	Thread Z-d	Price(F)	Body Diameter A	Thread B	Reg Dia D	Reg Len E	Hub Dia F	(mm) Hub Len G	Boss Len g	Face Len H (G+h)	All Len J (g+H)	Boss Dia K
3900-3304	4"	1"~8	38.94	100	1"~8	1"	5	56	10	3	26	29	72
3900-3306	4"	M39x4	38.94	100	M39x4	40mm	10	56	24	3	40	43	72
3900-3305	4"	None	38.94	100	None	10mm	10	56	24	3	40	43	72
3900-3308	5"	1"~8	67.29	130	1"~8	1"	5	56	10	4	26	30	100
3900-3309	5"	1"~10	67.29	130	1"~10	1"	6.35	56	10	4	26	30	100
3900-3311	6"	1"~8	84.15	160	1"~8	1"	10	56	10	4	26	30	130
3900-3312	6"	1"~10	84.15	160	1"~10	1"	NONE	56	10	4	26	30	130
3900-3313	6"	None	84.15	160	UNTHREADED	NONE	10	75	24	4	40	44	130
3900-3315	6"	1-1/2"~8	84.15	160	1-1/2"~8	1-1/2"	10	56	14	4	30	34	130
3900-3322	6"	2-1/4"~8	84.15	160	2-1/4"~8	2-1/4"	10	75	16	4	32	36	130
3900-3339	6"	M39 x 4	84.15	160	M39X4	40mm	10	56	24	4	40	44	130
3900-3324	8"	1-1/2"~8	129.66	200	1-1/2"~8	1-1/2"	10	56	24	6.35	40	46.35	124.46
3900-3326	8"	2-1/4"~8	129.66	200	2-1/4"~8	2-1/4"	10	75	24	6.35	40	46.35	124.46
3900-3340	8"	None	129.66	200	NONE	NONE	10	75	24	6.35	40	46.35	124.46

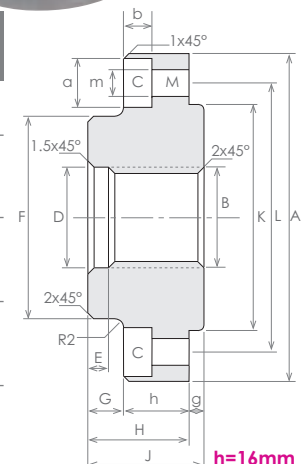

LATHE CHUCKS, JAWS & BACK PLATES

6" 3-JAW SELF-CENTERING LATHE CHUCKS - THREADED DIRECT MOUNT

- Made of high quality semi-steel.
- Hardened and precision ground.
- Wrench is included.

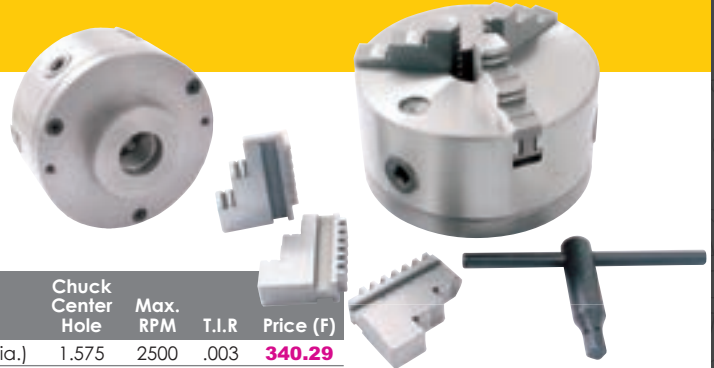
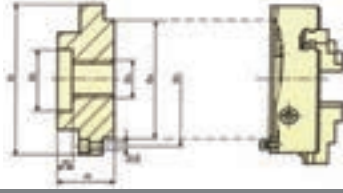

**2 SETS OF HARD JAWS
(INTERNAL AND EXTERNAL) &
1 SET OF MOUNTING SCREWS INCLUDED**

Item#	Size D	Back Plate Thread D3	(Inch)					z-d	Chuck Center Hole	Max. RPM	T.I.R	Price (F)
			D1	D2	D4	H	H1					
3900-4722	6"	1-1/2"-8	1.55	5.6	130	40	13	3x9mm(Dia.)	1.575	2500	.003	340.29
3900-4724	6"	2-1/4"-8	2.34	5.6	130	40	17.5	3x9mm(Dia.)	1.575	2500	.003	315.70

STEEL HARD INTERNAL & EXTERNAL JAW SETS-For K11 Lathe Chucks

- Set includes 3pcs
- Fits most of 3-jaw self-centering lathe chucks with replaceable **internal & external** jaws.

FOR 3-JAW CHUCKS



External Jaws Shown

EXTERNAL SET

Item#	Fits Chuck Size	Price (F)
3900-4730	3"	42.98
3900-4732	4"	44.68
3900-4734	5"	46.20
3900-4736	6"	48.10
3900-4738	8"	55.19

INTERNAL SET

Item#	Fits Chuck Size	Price (F)
3900-4740	3"	40.96
3900-4742	4"	44.27
3900-4744	5"	45.50
3900-4746	6"	46.95
3900-4748	8"	49.70



Internal Jaws Shown

2MT MORSE TAPER SHANK 3 & 4-JAW SELF-CENTERING CHUCKS

- Steel body-hardened and ground scroll and pinions
- Hardened and ground MT spindle
- Supplied with chuck wrench.
- 3/8-16 threaded drawbar.
- 2 MT shank.
- T.I.R. 0.0006".

**2 SETS OF SOLID STEEL JAWS
(INTERNAL AND EXTERNAL)**

3", 3 JAW
3900-4706
\$16533
(E)

3", 4 JAW
3900-4707
\$22335
(E)



3900-4706 SHOWN

5C MOUNTS FOR 3&4 JAW LATHE CHUCKS -5C Adapter with Standard Internal & External Threads

- 5C adapter body.
- 3 hole chuck mounting pattern is pre-drilled.
- Hardened and ground.

3 Inch
3900-4703
\$4423
(E)

4 Inch
3900-4704
\$4678
(E)



REVOLVING TAILSTOCK BACK PLATES

- Used for calibration or support workpiece during processing.
- Three ball bearings for heavy duty load and relatively high speed.
- 3 hole chuck mounting pattern is pre-drilled.

*Limited Supply

Item#	Shank Taper	A	Fits Lathe Chuck	(mm)				Max Load (lbs)	T.I.R. (Inch)	Speed RPM	Price (E)
				B	C	D	E				
3900-6022	MT2	17.78	3"	80	64	55	66	1100	.0002	4000	229.54
3900-6021*	MT2	17.78	4"	100	64	72	84	1100	.0002	2500	216.35
3900-6023	MT3	23.83	3"	80	81	55	66	1760	.0002	4000	206.67
3900-6026	MT3	23.83	4"	100	81	72	84	1760	.0002	2500	296.22
3900-6024	MT4	31.27	4"	100	103	72	84	2200	.0002	2500	296.22
3900-6025*	MT5	44.40	5"	125	130	95	108	3300	.0004	2000	462.74
3900-6030	MT4	31.27	5"	125	103	95	108	2200	.0004	2000	437.25
3900-6031	MT5	44.40	6"	160	130	130	142	3300	.0004	1500	644.93

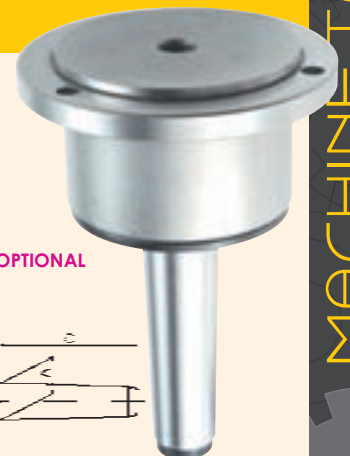

LATHE CHUCK OPTIONAL

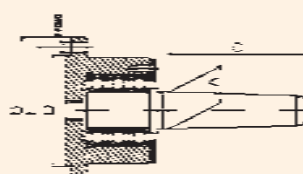

CHUCK ADAPTERS

A, D & L MOUNT SEMI-MACHINED CHUCK ADAPTERS - BACK PLATES

- Back plates for universal chucks
- Plain-back chucks require the adapter plate to be machined before mounting to ensure concentricity

MADE OF HIGH GRADE CASTING STEEL

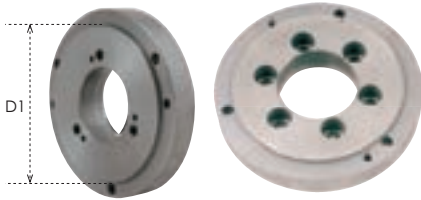

A-MOUNT

A-MOUNT

Item#	Chuck Size	Spindle	D1	Price (E)
3900-4841	8-1/4"	A1-5	6.555"	160.86
3900-4843	10"	A1-6	6.555"	194.97
3900-4844	10"	A1-8	8.189"	194.97
3900-4845	12"	A1-6	10.315"	317.61

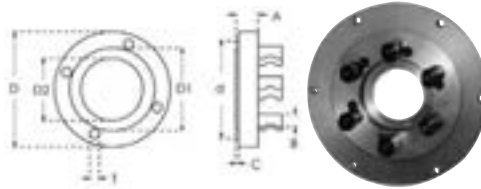

D-MOUNT

D-MOUNT

Item#	Chuck Size, D	Spindle	Recess D1	Price (E)
3900-4822	6"	D-3	2.125"	111.93
3900-4823	6"	D-4	2.501"	111.93
3900-4826	8"	D-3	2.125"	151.26
3900-4827	8"	D-4	2.501"	151.26
3900-4898	8"	D-5	3.251"	150.60
3900-4829	8"	D-6	4.188"	151.26
3900-4835	10"	D-6	4.188"	208.89
3900-4837	10"	D-8	5.501"	208.89
3900-4891	12"	D-6	4.188"	223.56
3900-4892	12"	D-8	5.501"	305.25
3900-4895	15"	D-11	7.751"	445.50

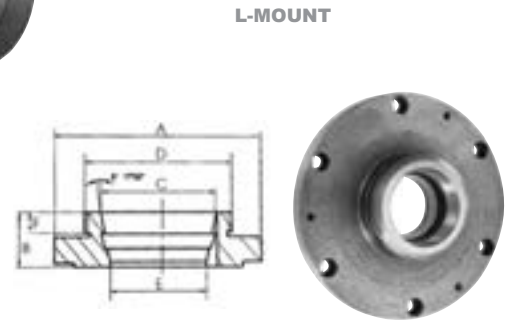

L-MOUNT

L-MOUNT

Item#	Chuck Size A	Spindle	Thread T-UN33 D	B	Price (E)
3900-4847	6"	L-00	3-3/4~6	2.13"	189.09
3900-4849	8-1/4"	L-00	3-3/4~6	2.13"	210.78

5C 5" COLLET CHUCKS

- Designed for use with 5C collets
- Used for turning, facing, boring, grinding and milling on center lathes and grinding machines
- Key-operated scroll provides a uniform distortion-free clamping of workpieces and low collet exchange times
- Chuck wrench included



D1-4 SHOWN



T.I.R <0.0006"

Item#	Spindle	Bolt Circle	Studs Included	Dis. of Studs	Price (E)
3900-4714	Plain Back	4.252"	--	---	484.98
3900-4715	D1-4	3.252"	3	5/8	533.47
3900-4717	D1-5	3.252"	6	3/4	581.97
3900-4716	D1-6	5.252"	6	7/8	581.97
3900-4718	D1-8	6.748"	6	1	727.45

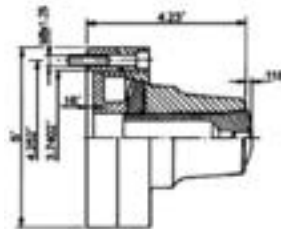

SPECIFICATIONS

Chuck Size.....5"
 Collet capacity.....1/16-1-1/8"
 Weight.....Approx. 13 lbs
 Max. RPM.....6,000

ER-40 COLLET CHUCK FIXTURE - Direct Mount

- Concentricity .0008"
- 5" diameter.
- Easily mount to lathe with D1 spindle.
- Accepts ER-40 collets.

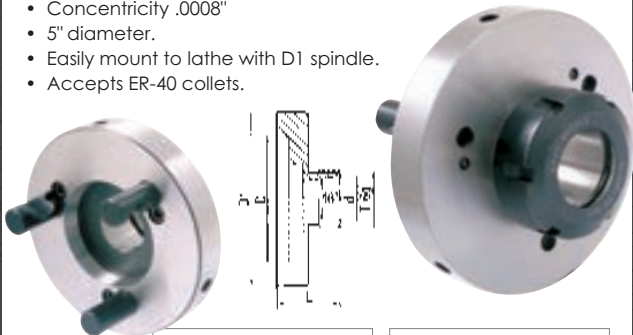

D1-3 Mount
3901-5041
\$1196⁴
 (F)

D1-4 Mount
3901-5042
\$1214⁷
 (F)

Item#	Mount	No. of Stud	Dia. of Stud	D1 (mm)	D (mm)	L (mm)
3901-5041	D1-3	3	9/16"	125	54	42
3901-5042	D1-4	3	5/8"	125	64	42

ER COLLET FIXTURES

- Mount to your choice of backplate for using on a lathe or could be used as a fixture on a milling table.
- Concentricity .0016"

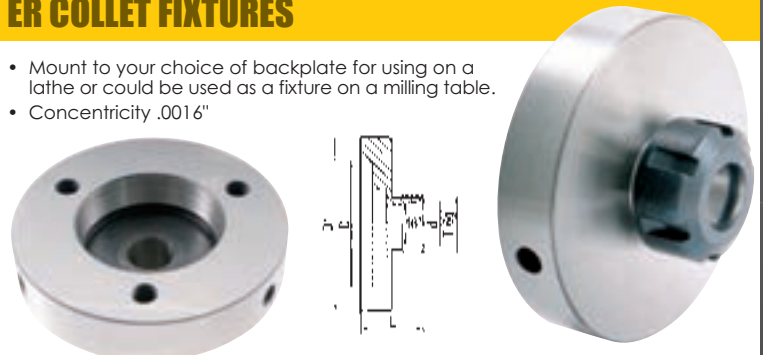

Item#	Type	No. of Bolt Hole	Bolt Hole Circle (mm)	Bolt Hole Size	D1 (mm)	D (mm)	L (mm)	Price (F)
3901-5016	ER-16	4	35	5mm	45	22	25	85.00
3901-5025	ER-25	3	75	M10	102	52	36	96.87
3901-5032	ER-32	3	66	M6	80	55	42	92.15
3901-5033	ER-32	3	84	M8	100	72	42	94.86
3901-5034	ER-32	3	125	M8	130	100	42	97.67
3901-5035	ER-32	3	125	M8	160	130	42	185.65
3901-5036	ER-40	3	84	M8	100	72	42	107.04
3901-5038	ER-40	3	115	M10	132	100	42	123.73

ZERO-SET LATHE CHUCKS & BACK PLATES

3 & 6-JAW ZERO-SET SELF-CENTERING LATHE CHUCKS - Plain Back

- Semi-Steel
- Run true "0" set.
- Made of high grade cast steel.
- Hardened and ground to the highest T.I.R. 0.0005" repeatability.
- Two piece top & master jaws are American standard tongue & groove.
- 2pc top Jaws can be reversed for clamping and jamming.
- 6-jaw models provide increased gripping force with less jaw distortion

T.I.R. <0.0005"

OPPOSING ADJUSTING SCREWS FOR "DEAD TRUE" ACCURACY

.0005" REPEATABILITY ON DUPLICATE PARTS



FINE ADJUSTMENT • PLAIN BACK

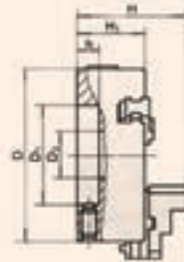

WORKINGHOLDING CAPACITIES

3-Jaw

Item#	Chuck Dia. D	D1	D2	(Inch) Center Hole D3	H	H1	h	z-d	Max. RPM	Wt. (lbs)	Price (F)
3900-4576	6	3.125	5.343	1.535	3.88	2.32	0.689	1/4-20	3,400	19	811.51
3900-4578	8.27	4.750	7.500	2.264	5.21	3.12	0.752	3/8-16	3,100	50	1,058.05
3900-4580	10	6.374	4.375	2.835	6.06	3.49	0.803	7/16-14	2,700	70	1,425.60
3900-4582*	12	7.905	5.250	3.268	6.57	3.98	0.803	1/2-13	2,200	116	1,733.00

*Limited Supply

Chuck Dia.	OD Min.	OD Max.	ID Min.	ID Max.
6	0.125	6.00	1.875	5.75
8.27	0.200	8.25	2.125	6.75
10	0.500	9.36	2.937	8.72
12	0.500	11.31	3.281	10.13

6-Jaw

Item#	Chuck Dia. D	D1	D2	(Inch) Center Hole D3	H	H1	h	z-d	Max. RPM	Wt. (lbs)	Price (F)
3900-4560*	6	3.125	5.343	1.535	3.88	2.32	0.689	1/4-20	2,500	19	1,072.50
3900-4563*	12	7.905	5.250	3.268	6.57	3.98	0.803	1/2-13	1,500	140	2,948.00

Chuck Dia.	OD Min.	OD Max.	ID Min.	ID Max.
6	0.200	6.00	1.875	5.75
8.27	0.425	8.25	2.125	6.75
10	0.625	9.36	2.937	8.72
12	0.775	11.31	3.281	10.13

ZERO-SET MOUNTING PLATES, A-Mount

FOR ZERO-SET 3&6 JAW CHUCKS

- Designed for easy installation.
- Zero-set recessed design minimizes overhang.
- All Zero-set mountings are interchangeable on the same size chuck.



A-MOUNT- American Standard Flange Nose.

Item#	Chuck Size	Spindle	Price (F)
3900-4900	6	A-5	126.15
3900-4901*	6"	A-6	135.15
3900-4902	8"	A-5	151.06
3900-4903*	8"	A-6	156.39
3900-4905	10"	A-5	215.37
3900-4906*	10"	A-6	215.37
3900-4907*	10"	A-8	215.37

*Limited Supply

ZERO-SET MOUNTING PLATES, D-Mount

FOR ZERO-SET 3&6 JAW CHUCKS

- Designed for easy installation.
- Zero-set recessed design minimizes overhang.
- All Zero-set mountings are interchangeable on the same size chuck.

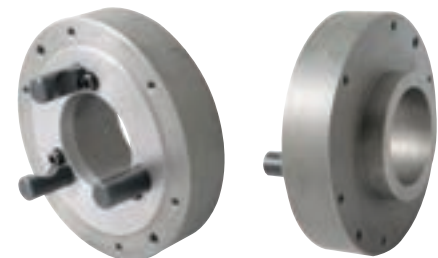

D-MOUNT-Camlock

Item#	Chuck Size	Spindle	Price (F)
3900-5606	6"	D-4	138.18
3900-5607	8"	D-4	187.39
3900-5608	8"	D-6	187.39
3900-5610	10"	D-5	246.40
3900-5611	10"	D-6	246.40
3900-5612	10"	D-8	256.81
3900-5618	12"	D-8	294.09
3900-5619	12"	D-6	294.09
3900-5621	12"	D-11	297.85

3-JAW SELF-CENTERING LATHE CHUCKS

3-JAW D1 SELF-CENTERING SCROLL CHUCKS - DIRECT MOUNT

- Direct Mounting chuck with Camlock Nose.
- Body made of high grade semi-steel.

D-MOUNT



- Top jaws are reversible.
- Self centering jaws, hardened and precision ground.
- Lathe chuck wrench supplied.

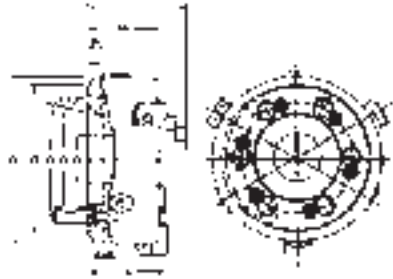

SPINDLE NOSE DIMENSIONS

Spindle Nose	D-3	D-4	D-6	D-8	D-11
Dia.	2.13"	2.50"	4.19"	5.50"	7.75"

2PC TOP REVERSIBLE HARD JAWS

Item#	Chuck Dia. D5	To Fit Spindle	Max. RPM	T.I.R.	Studs B.C. D2	Studs Included	Dia. of Stud	Center Hole D3	D1	H	H1	h	Z-d	Weight (Lbs)	Price (E)
3900-4605	6"	D1-3	2500	.003	2.780	3	9/16	1.575	2.130	4.5	3.0	0.512	M10x1	23	297.00
3900-4606	6"	D1-4	2500	.003	3.252	3	5/8	1.575	2.130	4.5	3.0	0.512	M10x1	23	312.13
3900-4607	8"	D1-4	2000	.004	3.252	3	5/8	2.362	2.500	5.3	3.4	0.630	M10x1	45	432.70
3900-4609	8"	D1-5	2000	.004	3.252	6	3/4	2.560	2.500	5.3	3.4	0.630	M10x1	45	432.70
3900-4608	8"	D1-6	2000	.004	5.252	6	7/8	2.362	4.188	5.3	3.4	0.630	M16x1.5	45	432.70
3900-4630	10"	D1-5	1600	.004	3.252	6	3/4	3.145	4.188	6.0	3.9	0.709	M10x1	75	539.00
3900-4631	10"	D1-6	1600	.004	5.252	6	7/8	3.145	4.188	6.0	3.9	0.709	M20x1.5	75	539.00
3900-4610	10"	D1-8	1600	.004	6.748	6	1	2.750	5.500	6.0	3.9	0.709	M20x1.5	75	539.00
3900-4615	12"	D1-6	1200	.005	5.252	6	7/8	3.937	4.188	6.7	4.2	0.709	M20x1.5	130	1,020.93
3900-4612	12"	D1-8	1200	.005	6.748	6	1	3.937	5.500	6.7	4.2	0.709	M20x1.5	130	1,020.93
3900-4616	15"	D1-11	1100	.005	9.252	6	1-3/16	5.315	5.500	6.7	4.6	0.709	M22x1.5	225	1,595.95

Larger sizes available

Pro-Series 3-JAW D1 SELF-CENTERING SCROLL CHUCKS - DIRECT MOUNT

- Semi-steel body.
- Direct mount self-centering scroll chucks.
- American standard two piece top reversible tongue & groove Jaws.
- All guide ways & bearing surfaces are precisely ground.
- Pinions are hardened & ground
- Scroll plate is dropped forged of fine alloy steel and case fully hardened. Thread flanks are ground on both sides for smooth operation.

2PC TOP REVERSIBLE HARD JAWS

AMERICAN STANDARD

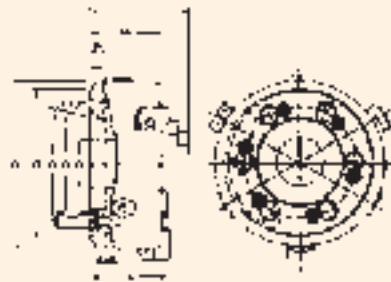
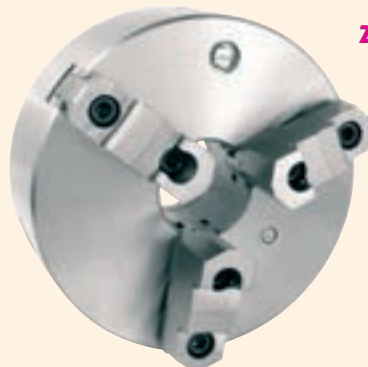

Item#	Chuck Dia. D5	To Fit Spindle	Max. RPM	T.I.R.	Studs B.C. D2	Studs Included	(Inch) Dia. of Stud	Center Hole D3	D1	H	H1	h	Z-d	Weight (Lbs)	Price (E)
3900-8005	5"	D1-4	3200	.003	3.252	3	5/8	1.260	2.501	4.33	2.76	0.512	M10x1	11	732.05
3900-8008	6"	D1-3	3000	.003	2.780	3	9/16	1.654	2.125	4.90	3.21	0.512	M10x1	20	919.60
3900-8009	6"	D1-4	3000	.003	3.252	3	5/8	1.654	2.501	4.90	3.21	0.512	M10x1	20	919.60
3900-8013	8"	D1-3	2500	.003	2.780	3	9/16	2.028	2.125	5.35	3.58	0.512	M10x1	42	1,240.25
3900-8014	8"	D1-4	2500	.003	3.252	3	5/8	2.165	2.501	5.35	3.58	0.512	M10x1	42	1,240.25
3900-8015	8"	D1-5	2500	.003	4.126	6	3/4	2.165	3.251	5.35	3.58	0.563	M12x1	42	1,240.25
3900-8016	8"	D1-6	2500	.003	5.252	6	7/8	2.165	4.188	5.35	3.58	0.563	M16x1.5	42	1,240.25
3900-8020	10"	D1-5	2000	.003	4.126	6	3/4	2.992	3.251	6.16	4.08	0.563	M12x1	71	1,566.95
3900-8021	10"	D1-6	2000	.003	5.252	6	7/8	2.992	4.188	6.16	4.08	0.630	M16x1.5	71	1,566.95
3900-8022	10"	D1-8	2000	.003	6.748	6	1	2.992	5.501	6.16	4.08	0.709	M20x1.5	71	1,566.95
3900-8024	12"	D1-6	1500	.0035	5.252	6	7/8	4.055	4.188	6.88	4.64	0.630	M16x1.5	112	2,299.00
3900-8025	12"	D1-8	1500	.0035	6.748	6	1	5.354	5.501	6.88	4.64	0.709	M20x1.5	112	2,299.00
3900-8028	15"	D1-8	1000	.004	6.748	6	1	5.354	5.501	7.70	5.06	0.709	M20x1.5	223	3,490.85
3900-8030	15"	D1-11	1000	.004	9.252	6	1-3/16	5.906	7.751	7.70	5.06	0.787	M22x1.5	223	3,490.85

4-JAW LATHE CHUCKS & WRENCHES

4 - JAW CAMLOCK SPINDLES "D-1" LATHE CHUCKS - Direct Mount

- Direct Mounting chuck with Camlock Nose.
- Body made of high grade semi-steel.
- Jaws are individually adjustable, allowing firm gripping of odd shaped work.
- Hardened and precision ground reversible jaws.
- With T-wrench.

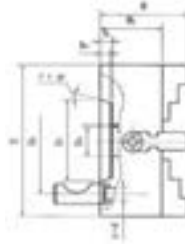

SPINDLE NOSE DIMENSIONS

Spindle Nose Dia.	D-3	D-4	D-6	D-8
	2.13"	2.50"	4.19"	5.50"

Item#	Chuck Dia. D	To Fit Spindle	Studs B.C. D2	Studs Included	Dia. of Stud	(Inch) Center Hole D3	D1	H	H1	h	Z-d	Weight (Lbs)	Price (E)
3900-4808	8"	D1-4	3.346	3	5/8	2.165	2.500	4.2	3.0	0.518	M10x1	37	303.45
3900-4810	10"	D1-6	5.252	6	7/8	2.953	4.190	4.7	3.2	0.630	M16x1.5	52	390.61
3900-4809	12"	D1-6	5.252	6	7/8	3.740	4.188	5.3	3.6	0.630	M16x1.5	100	764.14
3900-4878	16"	D1-8	6.748	6	1	4.921	5.500	5.6	3.7	0.709	M20x1.5	140	1,014.05

Pro-Series 4-JAW INDEPENDENT "D-1" LATHE CHUCKS - DIRECT MOUNT

STANDARD ACCESSORIES

- 1 set of American Standard reversible jaws.
- 1 T-wrench
- 2 Hex keys
- 2 eye bolts for chucks 10" & up
- 1 set of mounting bolts.

- Semi-steel body.
- Hard solid reversible jaws.

10" & Up Include T-slot

AMERICAN STANDARD

DESIGNED TO GRIP ROUND OR ODD SHAPED WORK



3900-8110 Shown



Item#	Chuck Dia. D	To Fit Spindle	Studs B.C. D2	Studs Included	Dia. of Stud	(Inch) Center Hole D3	D1	H	H1	h	Z-d	Price (E)
3900-8110	8"	D1-4	3.252	3	5/8	2.205	2.501	4.33	2.95	0.512	M10x1	871.20
3900-8111	8"	D1-5	4.126	6	3/4	2.205	3.251	4.33	2.95	0.590	M12x1	871.20
3900-8113	10"	D1-5	4.126	6	3/4	2.953	4.188	4.70	3.35	0.630	M16x1.5	1,149.50
3900-8114	10"	D1-6	5.252	6	7/8	2.953	4.188	4.70	3.35	0.630	M16x1.5	1,149.50
3900-8118	12"	D1-6	5.252	6	7/8	2.953	4.188	5.70	3.74	0.630	M16x1.5	1,700.05
3900-8122	12"	D1-8	6.748	6	1	3.740	5.501	5.70	3.74	0.709	M20x1.5	1,700.05
3900-8126	16"	D1-8	6.748	6	1	4.921	5.501	6.10	4.13	0.709	M20x1.5	2,438.15
3900-8130	20"	D1-11	9.252	6	1-3/16	4.921	7.751	7.07	4.72	0.787	M22x1.5	3,908.30

Larger sizes available

CHUCK WRENCHES/KEYS

- Made of high quality tool steel.
- Hardened & tempered.
- Heavy duty construction.



STANDARD

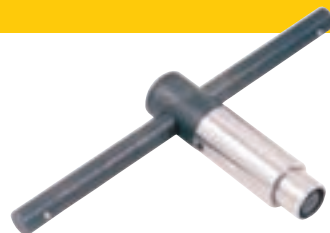

SELF-EJECT



*Limited Supply

Square Head Size	Standard Item#	Price (E)	Self-Eject Item#	Price (E)
15/64"(6mm)	3900-4862	8.29	-----	
9/32"(7.15mm)	3900-4863	8.96	-----	
15/32"(12mm)	3900-4864	16.95	-----	
1/4"(6.35mm)	3900-4865	9.95	-----	
5/16"(8mm)	3900-4866	10.76	3900-4857	20.40
3/8"(9.5mm)	3900-4867	11.43	3900-4853*	20.84
7/16"(11.2mm)	3900-4868	14.94	-----	
1/2"(12.7mm)	3900-4869	15.58	3900-4855	25.61
9/16"(14.3mm)	3900-4870	16.08	-----	
5/8"(16mm)	3900-4871	24.20	-----	
11/16"(17.5mm)	3900-4872	26.00	-----	
3/4"(19mm)	3900-4873	34.10	-----	

HIGH SPEED POWER CHUCKS

TaiKi 2-JAW CNC POWER CHUCKS - Direct Mount

Interchangeable with Kitagawa BT200 series chucks • Chuck adaptor suit to spindle nose A2 • Serrations Pitch 1.5mm X 60°

- Optimum for gripping irregular shaped works.
- Approx. 20% higher speed, gripping force and larger bore when compared to conventional chucks.
- Made from high grade alloy steel. All sliding surfaces are hardened and ground for accurate actual running and long service repeatability.
- **Standard Equipment:** Chuck comes fitted with chuck adaptor and includes mounting bolts, T-nuts and jaw mounting bolts. Also included blank drawnut and mounting wrench.

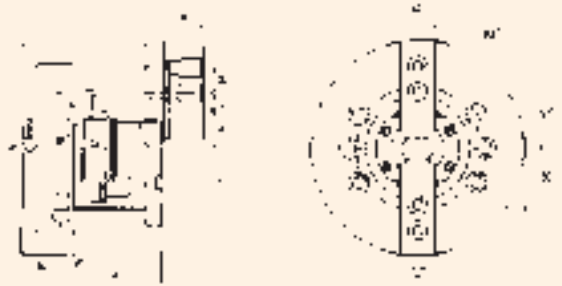

Limited Supply!

MADE IN TAIWAN

Item#	Chuck Size	Chuck Dia. (mm)	Thru-hole Dia.	Plunger Strok (mm)	Jaw Strok Diameter (mm)	Max. Draw Bar Pull Force (kgf)	Max. Gripping Force (kgf)	Max. Speed RPM	Max. Hydraulic Pressure (kgf/cm ²)	Mount Spindle	Cross to Kitagawa	Price (E)
3900-4597	5"	135	1.299"	10	5.4	1050	2960	7000	24.3	A2-4	BT-205	1,562.00
3900-4599	8"	210	2.047"	16	7.4	2250	5600	4800	18.4	A2-6	BT-208	1,716.00

DIMENSIONS (mm)

Chuck Size	A		B		C (H6)		F		H		J		K		L		M		N		O		P		Q		R		S		T		U	
	Max.	Min.	Max.	Min.	Max.	Min.	Max.	Min.	Max.	Min.	Max.	Min.	Max.	Min.	Max.	Min.	Max.	Min.	Max.	Min.	Max.	Min.	Max.	Min.	Max.	Min.	Max.	Min.	Max.	Min.				
5"	65	135	110	4	82.55	33	4-M10	14	14	26.5	23.80	19.5	6.0	1.0	-9.0	23	10	15.0	26	M40x1.5														
8"	91	210	170	5	133.35	52	6-M12	20	25	38.7	35.00	30.0	10.5	14.5	-1.5	35	14	16.5	37	M60x2.0														

TaiKi 3-JAW CNC POWER CHUCKS - Direct Mount

Interchangeable with Kitagawa B200 series chucks • Chuck adaptor suit to spindle nose A2 • Serrations Pitch 1.5mm X 60°

- Approx. 20% higher speed, gripping force and larger bore when compared to conventional chucks.
- Made from high grade alloy steel. All sliding surfaces are hardened and ground for accurate actual running and long service repeatability.
- **Standard Equipment:** Chuck comes fitted with chuck adaptor and includes mounting bolts, T-nuts and jaw mounting bolts.

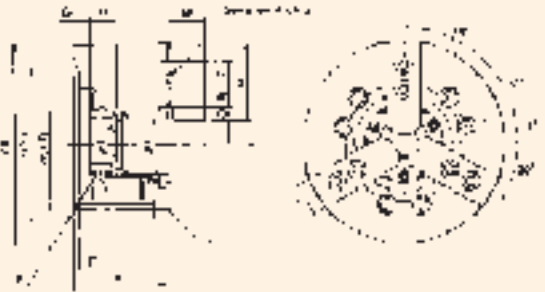

Limited Supply!

MADE IN TAIWAN

Item#	Chuck Size	Chuck Dia. (mm)	Thru-hole Dia.	Plunger Strok (mm)	Jaw Strok Diameter (mm)	Max. Draw Bar Pull Force (kgf)	Max. Gripping Force (kgf)	Max. Speed RPM	Max. Hydraulic Pressure (kgf/cm ²)	Mount Spindle	Cross to Kitagawa	Price (E)
3900-4585	5"	135	1.299"	10	5.4	1750	3600	7000	29	A2-4	B-205A4	1,276.00
3900-4588	8"	210	2.047"	16	7.4	3400	8500	4800	26	A2-6	B-208A6	1,430.00
3900-4592	12"	304	3.583"	23	10.6	5500	14400	3000	27	A2-8	B-212A8	2,970.00

DIMENSIONS (mm)

Chuck Size	A		B		C		D		E		F		G		H		J		K		L		M		N		P		Q		R		T	
	Max.	Min.	Max.	Min.	Max.	Min.	Max.	Min.	Max.	Min.	Max.	Min.	Max.	Min.	Max.	Min.	Max.	Min.	Max.	Min.	Max.	Min.	Max.	Min.	Max.	Min.	Max.	Min.	Max.	Min.				
5"	65	135	110	82.55	4	33	1.0	-9.0	20	12	M40x1.5	3-M10	26	54	14	26.5	23.80	19.5	6.0	23														
8"	91	210	170	133.35	5	52	14.5	-1.5	20.5	30	M60x2.0	6-M12	37	95	25	38.7	35.00	30.0	10.5	35														
12"	123	304	220	171.45	5	91	8.0	-15.0	28	50	M100x2.0	6-M16	48	129	30	61.3	56.00	46.5	12.0	48														

TaiKi JAW BORING RINGS - For Boring Soft & Round Jaws

How to install:

- Place the jaw boring ring over our chuck and locate the bring ring pins in the counterbore of your chuck jaws
 - Turn the jaw boring ring until snug
 - Activate your jaws
- The jaw boring ring will apply equal pressure on all jaws, allowing for a consistent bore.

- Since no discs or bungs are used to clamp jaws, through boring of jaws is possible.
- Attaches to front of jaws without tools, compensating for "jaw lift".
- Suitable for CNC lathe.
- Ideal for machining soft jaws.
- Applies equal pressure on all jaws.

MADE IN TAIWAN

Item#	Chuck Size	Dimensions (Inch)		Dimensions (Inch)					Price (E)
		A	B	C	D	E	F	G	
3900-4649	4"	.47	4.5	1.34	.47	1.10	.35	.51	206.24
3900-4650	5"	.47	5.5	2.36	.47	1.10	.35	.51	206.24
3900-4651	6"	.47	6.6	3.15	.47	1.26	.35	.65	228.63
3900-4654	8"	.47	8.6	4.53	.59	1.42	.35	.73	255.66
3900-4656	10"	.47	10.2	5.91	.67	1.57	.35	.73	283.18
3900-4658	12"	.59	12.4	7.40	.83	1.97	.35	.96	490.08
3900-4660	15"	.79	15.0	9.06	.91	2.05	.63	1.22	821.51

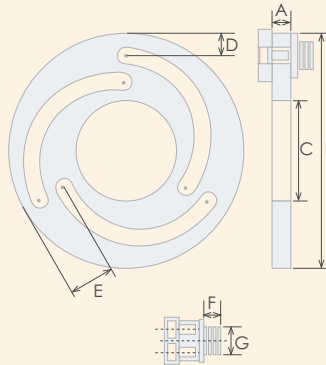

TaiKi TL-JAW BORING RINGS - For Boring Soft & Round Jaws

- Suitable for CNC lathe.
- Ideal for machining soft jaws.
- Attaches to front of jaws without tools, compensating for "jaw lift".
- Applies equal pressure on all jaws.
- Since no discs or bungs are used to clamp jaws, through boring of jaws is possible.

For 6, 8, 10" Chuck
3900-4668
\$572.91 (E)



How to install:

- Place the jaw boring ring over our chuck and locate the bring ring pins in the counterbore of your chuck jaws
 - Turn the jaw boring ring until snug
 - Activate your jaws
- The jaw boring ring will apply equal pressure on all jaws, allowing for a consistent bore.

- Set the jaws for the required job. The diameter of the jaws must be set smaller than the part diameter.
- adjust the Boring Rings to fit into the bolt holes of the soft jaws. Then, rotate the body of the Boring Rings until snug, pulling the jaws rigid in the opposite direction of the clamping force (away from the part to be held).
- Lock the chuck. Jaws must be locked in the direction of the part to be held. The soft jaws will then be held rigidly by the Boring Rings as if holding the part.
- Machining the diameter desired. The bore diameter must be precise with the diameter of the part to be held.
- Remove the Boring Rings. Unlock the chuck opposite in the locking direction.
- Chuck the part. If these steps are followed correctly, the part will be true within .0002 T.I.R.

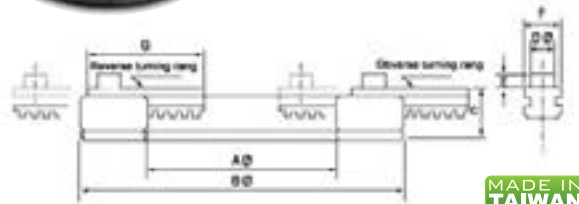

Item#	Chuck Size	Dimensions (Inch)		Jaw Stroke (ea.)	Max. Speed (RPM)	Price (E)
		A	B			
3900-4666	5,6,8"	3.94	6.7	1.02	800	518.29
3900-4668	6,8,10"	4.92	7.9	1.02	700	572.91
3900-4669	8,10,12"	6.30	9.8	1.22	600	682.58

TaiKi JAW NUTS & SCREWS

FOR USE ON: Kitagawa, Samchully, Strong, MMK, SMW Autoblok, Howa & Hitachi-Seiki Chucks

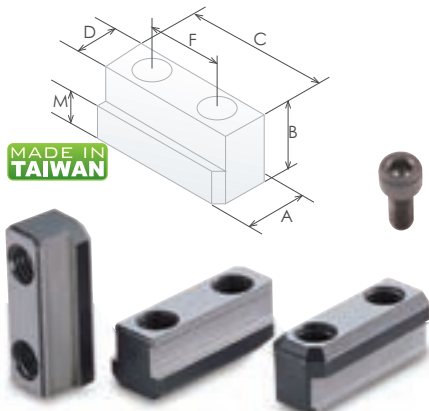

MADE IN TAIWAN

Chuck Size Inch	CRITICAL DIMENSIONS				Nut Dimensions			Jaw Nut (set of 3)		Screw Dimensions	
	Heel Height M	Groove Width D	Screw Size	Hole Space F	Nut Height B	Nut Width A	Nut Length C	Item#	Price (F)	Item#	Price (F)
5	0.197	0.393 (10mm)	M8x20	0.551	0.571	0.551	0.965	3900-4780	100.47	3900-4796	2.09
6	0.295	0.472 (12mm)	M10x25	0.787	0.728	0.689	1.417	3900-4781	100.47	3900-4797	2.09
6	0.276	0.472 (12mm)	M10x25	0.787	0.866	0.689	1.437	3900-4788	103.50	3900-4797	2.09
8	0.335	0.551 (14mm)	M12x30	0.984	0.807	0.807	1.831	3900-4782	112.00	3900-4798	2.62
8	0.394	0.551 (14mm)	M12x30	0.984	1.024	0.807	1.890	3900-4789	119.31	3900-4798	2.62
8	0.394	0.629 (16mm)	M12x30	1.181	0.807	0.807	1.890	3900-4782	112.00	3900-4798	2.62
10	0.335	0.629 (16mm)	M12x30	1.181	0.846	0.886	2.008	3900-4783	133.27	3900-4798	2.62
10	0.394	0.629 (16mm)	M12x30	1.181	1.024	0.886	2.165	3900-4790	137.80	3900-4798	2.62
10	0.394	0.629 (16mm)	M12x30	0.984	0.846	0.886	2.008	3900-4786	331.32	3900-4798	2.62
12	0.453	0.827 (21mm)	M16x40	1.181	1.102	1.102	2.185	3900-4784	173.76	3900-4799	3.42
12	0.531	0.709 (18mm)	M14x40	1.181	1.319	1.043	2.185	3900-4791	178.98	3900-4800	3.42
15	0.650	0.866 (22mm)	M20x60	1.693	1.791	1.319	3.150	3900-4786	331.32	3900-4801	3.14
15	0.748	1.004 (25.5mm)	M20x55	1.693	1.535	1.378	3.150	3900-4793	348.22	3900-4802	3.14
15	0.654	0.945 (24mm)	M16x40	1.181	1.719	1.280	2.363	3900-4795	355.04	3900-4799	3.42

CHUCK JAWS

TaiKi SOFT JAWS - 1.5 mm x 60 Degree Serrations

- Supplies maximum concentricity on finish turning operations
- Can be bored or turned to fit workpiece
- Jaws can be hardened
- Set includes 3 pcs

FOR USE ON: Kitagawa, Samchully, Strong, MMK, SMW Autoblok, Howa & Hitachi-Seiki Chucks

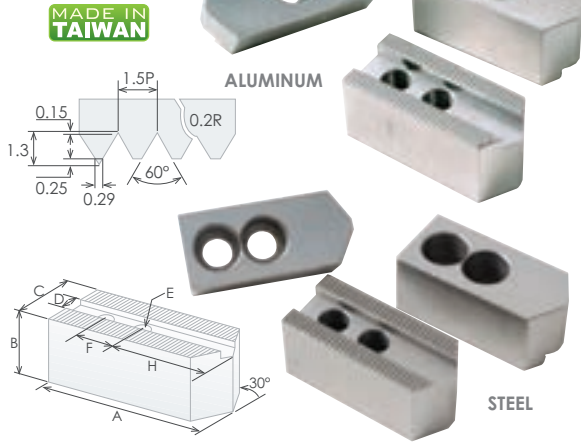

Chuck Size	CRITICAL DIMENSIONS				Width Inch C	Length Inch A	Height Inch B	STEEL (set of 3)		ALUMINUM (set of 3)	
	Groove Width D	Screw Size E	Hole Space F	Hole to Front H				Item #	Price(F)	Item #	Price(F)
4	0.394 (10mm)	5/16 (M8)	0.551 (14mm)	1-1/16	0.91	2.00	0.91	3900-4684	38.63	3900-4764*	55.31
6	0.472 (12mm)	3/8 (M10)	0.787 (20mm)	1-1/2	1.22	2.87	1.18	3900-4686	40.48	3900-4766	66.60
8	0.551 (14mm)	1/2 (M12)	0.984 (25mm)	1.811	1.38	3.74	1.46	3900-4688	44.98	3900-4768	76.83
10	0.630 (16mm)	1/2 (M12)	1.181 (30mm)	1.969	1.57	4.33	1.65	3900-4690	63.45	3900-4770	96.00
12	0.710 (18mm)	0.55 (M14)	1.181 (30mm)	2.362	1.89	5.08	1.89	3900-4692	114.45	3900-4772	140.85
12	0.827 (21mm)	0.63 (M16)	1.181 (30mm)	2.362	1.89	5.08	1.89	3900-4693	114.45	3900-4773	140.85
15	0.866 (22mm)	0.787 (M20)	1.690 (43mm)	3.346	2.44	6.50	2.44	3900-4695	213.30	3900-4775	249.65
15	1.003 (25.5mm)	0.787 (M20)	1.690 (43mm)	3.346	2.44	6.50	2.44	3900-4696	213.30	3900-4776	249.65

* Limited Supply

TaiKi SOFT STEEL JAWS EXTRA HEIGHT - 1.5mm x 60 Deg Serrations

FOR USE ON: Kitagawa, Samchully, Strong, MMK, SMW Autoblok, Howa & Hitachi-Seiki Chucks

- Extra-height jaws are suitable for longer workpiece, such as 4" length workpiece will need jaws with over 3" height which will increase the accuracy and stability of production process.
- Supplies maximum concentricity on finish turning operations.
- Price is for a set of 3 jaws.
- Jaws can be hardened.
- Can be bored or turned to fit workpiece.

MADE IN TAIWAN

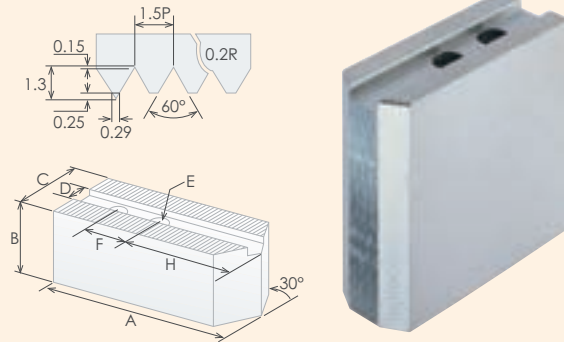

Chuck Size	CRITICAL DIMENSIONS				Hole to Front H	Jaw Width C	Jaw Length A	Jaw Height B	(set of 3) Item #	Price (F)
	Groove Width D	Screw Size E	Hole Space F	Hole to Front H						
6	0.472 (12mm)	3/8 (M10)	0.787 (20mm)	1-1/2	1.22	2.87	2.36 (60mm)	3900-5656	78.58	
6	0.472 (12mm)	3/8 (M10)	0.781 (20mm)	1-1/2	1.22	2.87	3.15 (80mm)	3900-5658	107.90	
8	0.551 (14mm)	1/2 (M12)	0.984 (25mm)	1.811	1.38	3.74	2.36 (60mm)	3900-5660	84.50	
8	0.551 (14mm)	1/2 (M12)	0.984 (25mm)	1.811	1.38	3.74	3.15 (80mm)	3900-5662	121.15	
8	0.551 (14mm)	1/2 (M12)	0.984 (25mm)	1.811	1.38	3.74	3.94 (100mm)	3900-5663	148.13	
10	0.630 (16mm)	1/2 (M12)	1.181 (30mm)	1.969	1.57	4.33	2.36 (60mm)	3900-5665	99.90	
10	0.630 (16mm)	1/2 (M12)	1.181 (30mm)	1.969	1.57	4.33	3.15 (80mm)	3900-5667	133.80	
10	0.630 (16mm)	1/2 (M12)	1.181 (30mm)	1.969	1.57	4.33	3.94 (100mm)	3900-5668	176.98	
12	0.710 (18mm)	0.55 (M14)	1.181 (30mm)	2.362	1.89	5.08	3.15 (80mm)	3900-5670	183.58	
12	0.710 (18mm)	0.55 (M14)	1.181 (30mm)	2.362	1.89	5.08	3.94 (100mm)	3900-5672	212.40	

TaiKi SOFT STEEL JAWS - 1/16" x 90 Degree Serrations

- Supplies maximum concentricity on finish turning operations
- Can be bored or turned to fit workpiece

- Jaws can be hardened, steel material SAE1045
- Set includes 3 pcs

FOR USE ON: SMW Autoblok, Rohm, Pratt Burnerd & Other Chucks

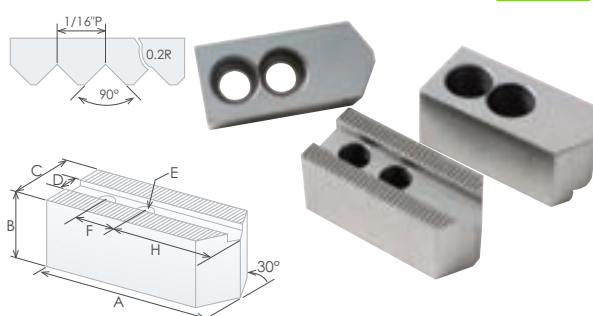

Chuck Size	CRITICAL DIMENSIONS				Width Inch C	Length Inch A	Height Inch B	(set of 3) Item #	Price (F)
	Groove Width D	Screw Size E	Hole Space F	Hole to Front H					
6	0.669 (17mm)	12mm	0.875 (22mm)	1.417	1.22	2.87	1.18	3900-4642	48.46
8	0.669 (17mm)	12mm	0.875 (22mm)	1.929	1.38	3.74	1.46	3900-4644	53.20
10	0.669 (17mm)	12mm	0.875 (22mm)	2.283	1.57	4.33	1.65	3900-4646	72.36
12	0.827 (21mm)	16mm	1.102 (28mm)	2.520	1.89	5.08	1.89	3900-4648	123.29

TaiKi BEST-GRIP HARD STEEL JAWS - 1.5 mm x 60 Degree Serrations

FOR USE ON: Kitagawa, Samchully, Strong, MMK, SMW Autoblok, Howa & Hitachi-Seiki Chucks

- Supplies maximum concentricity on finish turning operations
- Set includes 3 pcs

Chuck Size	CRITICAL DIMENSIONS			No. of Holes	No. of Steps	Step Height S2	Step Height S3	Width Inch C	Length Inch A	Height Inch B	(set of 3) Item#	Price(F)
	Groove Width D	Screw Size E	Hole Space F									
6	0.472 (12mm)	M10	0.787 (20mm)	3	1	0	0.47	1.22	2.64	1.42	3900-4671	362.53
8	0.551 (14mm)	M12	0.984 (25mm)	3	2	0.47	0.47	1.38	3.39	2.01	3900-4673	418.41
10	0.630 (16mm)	M12	1.181 (30mm)	3	2	0.55	0.55	1.57	3.94	2.13	3900-4675	512.72
12	0.709 (18MM)	M14	1.181 (30mm)	3	1	0	0.79	1.97	4.45	2.05	3900-4677	733.82
12	0.827 (21mm)	M16	1.181 (30mm)	3	1	0	0.79	1.97	4.45	2.05	3900-4678	733.82
15	0.866 (22MM)	M20	1.693 (43mm)	3	2	0.73	0.73	2.44	5.63	3.39	3900-4680	1,256.14
15	1.005 (25.5MM)	M20	1.693 (43mm)	3	2	0.73	0.73	2.44	5.63	3.39	3900-4681	1,256.14

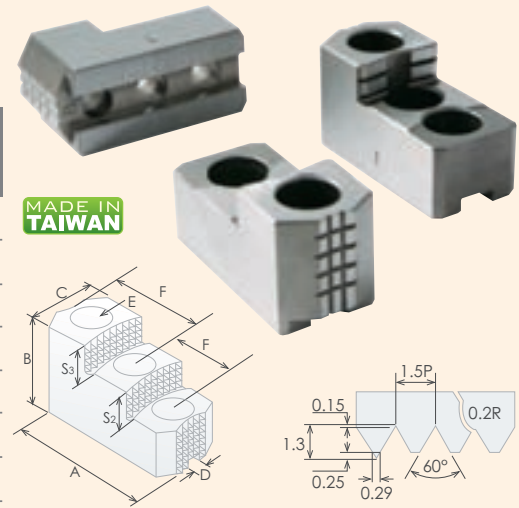

TaiKi SOFT ROUND/PIE JAWS - 1.5mm x 60 Deg Serrations

FOR USE ON: Kitagawa, Samchully, Strong, MMK, SMW Autoblok, Howa & Hitachi-Seiki Chucks

MADE IN TAIWAN

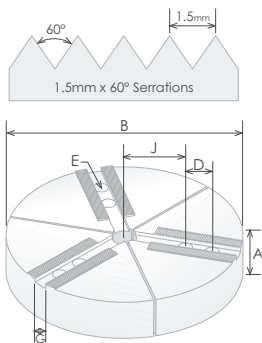

- Round jaws allow for complete gripping of workpiece.
- Can be machined to fit workpiece.
- Set includes 3 pcs

- Ideal for thin-walled or irregular shaped workpieces.
- Steel jaws can be hardened.

STEEL JAWS

Chuck Size	CRITICAL DIMENSIONS			Hole to Front J	Pie Dia. B	Thru Hole	Jaw Height A	(set of 3) Item #	Price (F)
	Groove Width G	Screw Size E	Hole Space D						
6-5/8"	0.472 (12mm)	M10	0.787 (20mm)	1.949	6.65	0.948	1.58	3900-5686	366.73
8"	0.551 (14mm)	M12	0.984 (25mm)	2.008	7.87	0.948	1.97	3900-5688	373.53
10"	0.63 (16mm)	M16	1.181 (30mm)	2.559	9.84	0.948	1.97	3900-5690	524.76
12"	0.827 (21mm)	M16	1.181 (30mm)	3.189	11.81	0.948	1.97	3900-5692	807.35

ALUMINUM JAWS

Chuck Size	CRITICAL DIMENSIONS			Hole to Front J	Pie Dia. B	Thru Hole	Jaw Height A	(set of 3) Item #	Price (F)
	Groove Width G	Screw Size E	Hole Space D						
6-5/8"	0.472 (12mm)	M10	0.787 (20mm)	1.949	6.65	0.948	1.58	3900-5695	278.59
8"	0.551 (14mm)	M12	0.984 (25mm)	2.008	7.87	0.948	1.97	3900-5697	310.36
10"	0.63 (16mm)	M16	1.181 (30mm)	2.559	9.84	0.948	1.97	3900-5700	427.84
12"	0.827 (21mm)	M16	1.181 (30mm)	3.189	11.81	0.948	1.97	3900-5702	716.10

TaiKi 3PC SET SOFT STEEL JAWS - AMERICAN STANDARD TONGUE & GROOVE

- Supplies maximum concentricity on finish turning operations
- Can be bored or turned to fit workpiece
- Jaws can be hardened
- Set includes 3 pcs

FOR USE ON: Buck, Bison, Cushman, Huron, PBA, Yuasa & Rohm Chucks

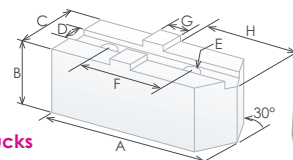

MADE IN TAIWAN



Chuck Size	CRITICAL DIMENSIONS				Tongue to Front H	Tongue Position C	Width Inch A	Length Inch B	Height Inch	Item #	(Set of 3) Price (F)
	Groove Width D	Tongue Width G	Screw Size E	Hole Space F							
6	0.313	1/2	5/16	1.500	0.866	Offset	1-1/4	2-7/8	1-1/4	3900-4756	46.55
8	0.313	1/2	3/8	1.750	1.329	Offset	1-1/4	3-3/4	1-1/4	3900-4758	50.23
10	0.500	3/4	1/2	2.125	1.220	Offset	1-1/4	4-1/8	1-1/4	3900-4760	52.30
12	0.500	3/4	1/2	2.500	1.398	Offset	1-9/16	4-15/16	2-1/8	3900-4762	118.28

KDK STYLE QUICK CHANGE TOOLS

MACHINE TOOL ACCESSORIES

KDK STYLE 6PC TOOL POST & HOLDERS SETS

- Interchangeable with KDK same series.
- All working parts hardened and ground.
- **Lathe Swing:**
8-12" (0 Series),
12-16" (100 Series),
15-18" (150 Series),
18-24" (200 Series)
- **Lock Down Bolt Diameter:**
7/16" (0 & 100 Series),
5/8" (150 Series),
3/4" (200 Series)
- **Center Height:**
.750" & Up (0 Series)
1.000" & Up (100 Series)
1.250" & Up (150 Series)
1.500" & Up (200 Series)

6PC/SET INCLUDES	
Holders:	
No. 1 - Turning & Facing	
No. 2 - Threading & Facing	
No. 3 - Extension Turning Bar	
No. 4 - Parting Bar	
No. 5 - Master Bar For Boring Bars	
Tool Post: KDK Body	



#0 Series Set
3900-5424
\$444³⁶
(F)

#100 Series Set
3900-5425
\$608²⁹
(F)

#150 Series Set
3900-5426
\$655⁷¹
(F)

#200 Series Set
3900-5427
\$911²⁷
(F)

T-slot nut & mounting bolt not included.

KDK STYLE 0, 100, 150, 200 TOOL POSTS

- Interchangeable with KDK same series.
- All working parts hardened and ground.
- **Lathe Swing:**
8-12" (0 Series), 12-16" (100 Series),
15-18" (150 Series), 18-24" (200 Series)
- **Lock Down Bolt Diameter:**
7/16" (0 & 100 Series), 5/8" (150 Series),
3/4" (200 Series)
- **Center Height:**
.750" & Up (0 Series)
1.000" & Up (100 Series)
1.250" & Up (150 Series)
1.500" & Up (200 Series)



T-slot nut & mounting bolt not included.

#0 Series Post
3900-5422
\$156²¹
(F)

#100 Series Post
3900-5423
\$242⁵³
(F)

#150 Series Post
3900-5457
\$275⁸⁷
(F)

#200 Series Post
3900-5458
\$335⁴³
(F)

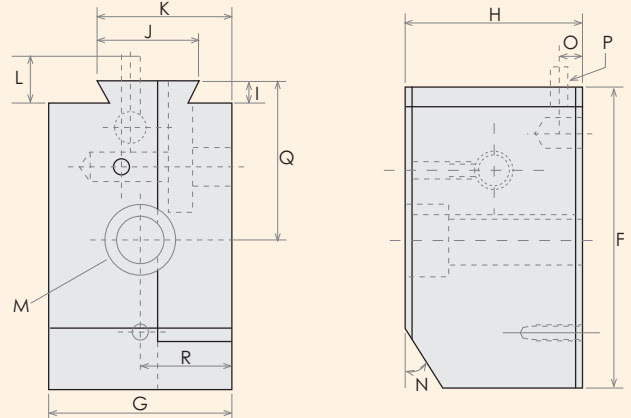

Body No.	(Inch)												
	F	G	H	I	J	K	L	M	N	O	P	Q	R
0	3.00	2.25	1.62	.312	1.750	1.875	.687	7/16	30°	.312	1/4	.687	1.343
100	3.50	2.50	2.25	.312	1.750	2.215	.687	7/16	30°	.331	1/4	.875	1.375
150	4.37	2.50	2.25	.312	1.750	2.215	.687	5/8	30°	.331	5/16	2.312	1.250
200	5.00	2.87	3.00	.312	1.750	2.215	.687	3/4	30°	.331	5/16	2.562	1.437

T-NUT BLANKS AND SCREW BOLTS FOR KDK STYLE TOOL POSTS

- T-nut blank can be machined to fit.

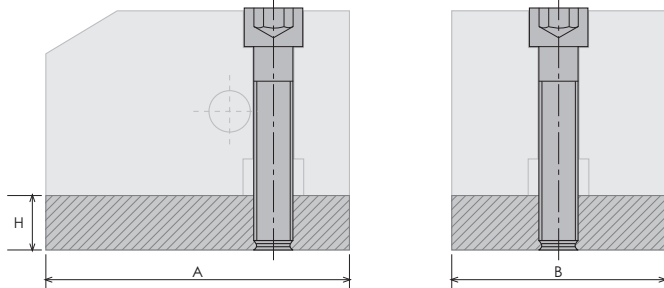
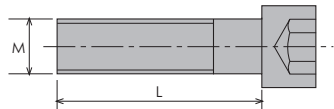

Item#	Fits Post No.	Blank Dimensions (Thick. H x B x A)	Bolt Thread M x L	Price (F)
3900-5436	100	1/2 x 1-1/2 x 2-1/4"	7/16-20UNF x 2.17"	20.71
3900-5437	100	5/8 x 2-1/4 x 2-3/4"	7/16-20UNF x 2.32"	26.60
3900-5438	100	3/4 x 2-1/2 x 3"	7/16-20UNF x 2.44"	26.60
3900-5439	150	5/8 x 2-1/4 x 2-3/4"	5/8-18UNF x 2.09"	26.60
3900-5440	150	3/4 x 2-1/2 x 3"	5/8-18UNF x 2.17"	26.60
3900-5441	150	7/8 x 2-1/2 x 3-1/2"	5/8-18UNF x 2.36"	35.47
3900-5442	150	1 x 3 x 4-1/2"	5/8-18UNF x 2.36"	35.47
3900-5443	200	7/8 x 2-1/2 x 3-1/2"	3/4-16UNF x 2.95"	35.47
3900-5444	200	1 x 3 x 4-1/2"	3/4-16UNF x 2.95"	35.47
3900-5445	200	1-1/2 x 4 x 5"	3/4-16UNF x 3.54"	57.63

5C COLLET BAR KDK STYLE 119 TOOL HOLDER

- No. 119 holder is for KDK-100, 150 & 200 quick change tool post.
- Assures the simplicity of preset quick change tools to all 5 C collet jobs.
- For lathes having 1" Center Height or more.
- Spanner Wrench and Lock Ring included.
- All working parts hardened and ground.

Holder No. 119
3900-5419
\$102⁹⁵
(F)

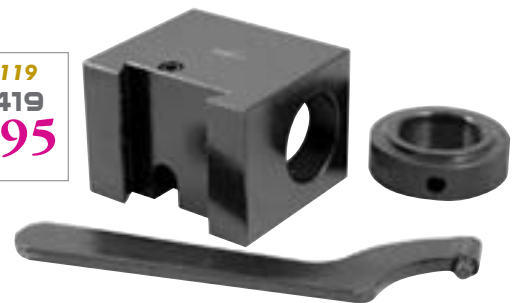

Replacement Ring Nut & Wrench (Item#3900-5420)\$18.69 (F)

KDK STYLE QUICK CHANGE HOLDERS

TURNING AND FACING BAR COMBINATION KDK STYLE 01, 101, 151, 201 TOOL HOLDERS



ALL BARS INTERCHANGEABLE ON 01, 100, 150 & 200 BODY

- Interchangeable with KDK same series tool holders.
- All working parts hardened and ground.

Item#	Holder No.	Wt. (lbs.)	Tool Bit Capacity	Lathe Swing	Price (F)
3900-5410	01	1.0	3/8"	8~12"	56.22
3900-5411	101	1.8	1/2"	12~16"	49.91
3900-5451	151	3.3	5/8"	15~18"	63.64
3900-5431	201	4.5	3/4"	18~24"	86.46
3900-5448	201-1	4.1	1"	18~24"	86.46

THREADING AND FACING BAR COMBINATION KDK STYLE 01, 102, 152, 202 TOOL HOLDERS



ALL BARS INTERCHANGEABLE ON 01, 100, 150 & 200 BODY

- Interchangeable with KDK same series tool holders.
- All working parts hardened and ground.

Item#	Holder No.	Wt. (lbs.)	Tool Bit Capacity	Lathe Swing	Price (F)
3900-5402	02	1.0	3/8"	8~12"	61.85
3900-5412	102	2.0	1/2"	12~16"	71.96
3900-5452	152	4.0	5/8"	15~18"	90.60
3900-5432	202	4.8	3/4"	18~24"	113.94
3900-5449	202-1	4.4	1"	18~24"	110.45

EXTENSION TURNING BAR COMBINATION KDK STYLE 03, 103, 153, 203 TOOL HOLDERS

- Interchangeable with KDK same series tool holders.
- All working parts hardened and ground.

Item#	Holder No.	Wt. (lbs.)	Tool Bit Capacity	Lathe Swing	Price (F)
3900-5403	03	1.0	3/8"	8~12"	81.30
3900-5413	103	1.8	1/2"	12~16"	98.08
3900-5453	153	3.3	5/8"	15~18"	108.94
3900-5433	203	4.5	3/4"	18~24"	130.59
3900-5450	203-1	4.0	1"	18~24"	132.58



ALL BARS INTERCHANGEABLE ON 01, 100, 150 & 200 BODY

PARTING BAR COMBINATION KDK STYLE 04, 104, 154, 204 TOOL HOLDERS

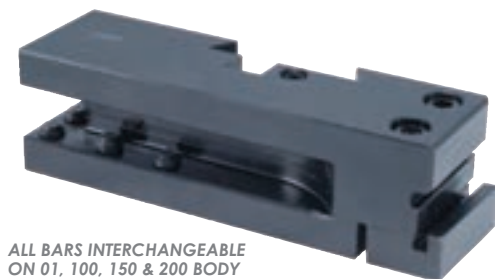

ALL BARS INTERCHANGEABLE ON 01, 100, 150 & 200 BODY

- Interchangeable with KDK same series tool holders.
- All working parts hardened and ground.

Item#	Holder No.	Wt. (lbs.)	Tool Bit Capacity (Thick. x Width)	Lathe Swing	Price (F)
3900-5404	04	1.5	3/32x1/2"	8~12"	89.91
3900-5414	104	2.3	1/8x11/16"	12~16"	92.44
3900-5454	154	4.3	1/8x7/8"	15~18"	100.13
3900-5434	204	5.0	1/8x1-1/8"	18~24"	142.56

MASTER BAR FOR BORING BARS KDK STYLE 05, 105, 155, 205 TOOL HOLDERS

- Interchangeable with KDK same series tool holders.
- All working parts hardened and ground.

Item#	Holder No.	Wt. (lbs.)	Boring Bar Capacity	Lathe Swing	Price (F)
3900-5405	05	1.3	3/4" Hole	8~12"	61.24
3900-5415	105	1.5	1" Hole	12~16"	69.24
3900-5455	155	3.8	1-1/4" Hole	15~18"	78.13
3900-5435	205	5.3	1-1/2" Hole	18~24"	102.28
3900-5429	205-1-3/4	8.1	1-3/4" Hole	18~24"	121.74
3900-5430	205-2	7.8	2" Hole	18~24"	143.84



ALL BARS INTERCHANGEABLE ON 01, 100, 150 & 200 BODY

QUICK-CHANGE TOOL SETS

6PC QUICK-CHANGE TOOL POST SETS - Piston Type

- Interchangeable with Aloris® and DORIAN® same series tool holders.
- All working parts hardened and ground.
- Completely sealed for maintenance-free operation.
- Increases productivity of all lathe operations.
- T-nut can be machined to fit.

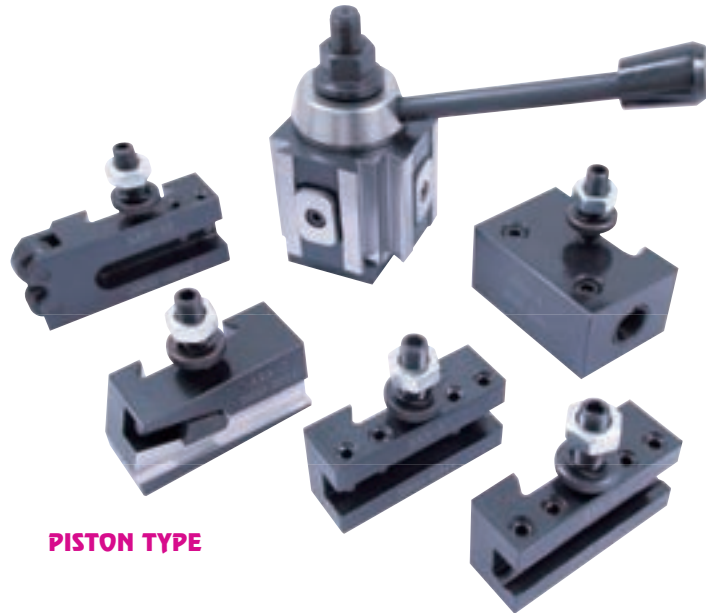

PISTON TYPE

BXA Series
3900-5920
\$31016 (F)

Interchangeable with **Aloris®** and **DORIAN®** same series

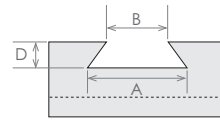

Dimension of Dovetails

- 6PC SET INCLUDES**
- Holders:
- No. 1 - Turning & Facing;
 - No. 2 - Boring, Turning & Facing
 - No. 4 - Boring, Heavy Duty;
 - No. 7 - Universal parting blade
 - No.10 - Knurling, Facing & Turning
- Tool Post: Piston Type

Series	Item#	A	B	D	Swing Capacity	Price (F)
AXA	3900-5910	1.64"	1.37"	0.383"	up to 12"	247.62
BXA	3900-5920	1.65"	1.41"	0.411"	10~15"	310.16
CXA	3900-5230	2.16"	1.68"	0.565"	13~18"	436.73
CA	3900-5260	2.62"	2.21"	0.493"	14~20"	636.35

6PC QUICK-CHANGE TOOL POST SETS - Wedge Type

- Interchangeable with Aloris® and DORIAN® same series tool holders.
- All working parts hardened and ground.
- Completely sealed for maintenance-free operation.
- Increases productivity of all lathe operations.
- Precision design to assure repetitive accuracy.
- T-nut can be machined to fit.



CXA Series
3900-5130
\$54381 (F)

Interchangeable with **Aloris®** and **DORIAN®** same series

WEDGE TYPE

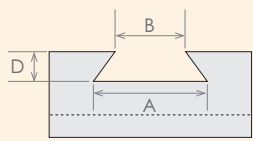

Dimension of Dovetails

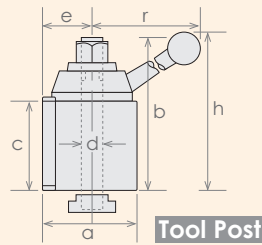

Tool Post



6PC SET INCLUDES

- Holders:
- No. 1 - Turning & Facing;
 - No. 2 - Boring, Turning & Facing
 - No. 4 - Boring, Heavy Duty;
 - No. 7 - Universal parting blade(4°)
 - No.10 - Knurling, Facing & Turning
- Tool Post: Wedge Type

Series	Item#	A	B	D	a	b	c	d	e	h	r	Swing Capacity	Price (F)
OXA	3900-5100	1.10"	0.92"	.257"	1-3/4	2-3/4	1-9/16	3/8	7/8	3-1/4	3-7/8	up to 8"	227.96
AXA	3900-5105	1.64"	1.37"	.383"	2-1/2	3-7/8	2-1/4	9/16	1-3/8	4-11/16	5-3/4	up to 12"	322.16
BXA	3900-5120	1.65"	1.41"	.411"	3	4-5/8	2-3/4	5/8	1-5/8	5-9/16	7-5/16	10~15"	397.22
CXA	3900-5130	2.16"	1.68"	.565"	3-1/2	5-1/8	3	3/4	1-7/8	6-1/8	7-7/8	13~18"	543.81
CA	3900-5140	2.62"	2.21"	.493"	4	6-1/4	3-5/8	7/8	2-1/8	7	9	14~20"	757.77
DA	3900-5160	3.25"	2.72"	.600"	5	7-5/8	4-5/8	7/8	2-11/16	8-1/4	10-7/8	17~48"	2,114.07

QUICK-CHANGE TOOL HOLDERS & SETS

6PC OXA MINI QUICK-CHANGE TOOL POST & HOLDER SETS - With Two No 1 Holders

- This true wedge type tool post set has maximum rigidity and provide chatter free performance.
- All working parts are hardened and ground. It is completely sealed for maintenance-free operation.
- Quick change tool post set for lathes with up to 9" swing. It requires 3/4" from the top of the compound rest to the center of the lathe.
- 60% of AXA, or series 100 size wedge type QCTP.

- It will hold turning tools with shanks from 1/4" to 1/2". The boring bar holder will hold 3/8" and 1/2" boring bars. It will hold 1/2" tall cut-off blades.
- This tool post mounts with an M10 stud that is included. It also includes a piece of steel from which you can make a T-slot nut to fit your lathe.
- All steel construction
- T-nut can be machined to fit.



KIT INCLUDES - 4° Parting Tool
 Tool post,
 2-#1 turning & facing tool holders,
 1- #2 boring,
 turning & facing tool holder,
 1-#4 heavy duty boring tool holder,
 1-#7 4° universal parting tool holder

Swing Capacity up to 9"
3900-5102
\$219²⁹
 (F)



KIT INCLUDES - 0° Parting Tool
 Tool post,
 2-#1 turning & facing tool holders,
 1-#2 boring,
 turning & facing tool holder,
 1-#4 heavy duty boring tool holder,
 1-#7 0° Universal parting tool holder

Swing Capacity up to 9"
3900-5101
\$231⁰⁰
 (F)

QUICK-CHANGE TOOL POSTS - Wedge Type

- All working parts hardened and ground.
- Completely sealed for maintenance-free operation

HHIP PRO-SERIES

Interchangeable with **Aloris®** and **DORIAN®** same series

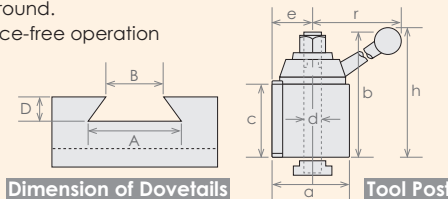

WEDGE TYPE

Series	Item#	A	B	D	a	b	c	d	e	h	r	Swing Capacity	Price (F)
OXA	3900-5460	1.10"	0.92"	.257"	1-11/16	2-19/32	1-1/2	3/8	15/16	3-9/64	3-27/32	up to 9"	115.25
AXA	3900-5161	1.64"	1.37"	.383"	2-1/2	3-7/8	2-1/4	9/16	1-3/8	4-11/16	5-3/4	up to 12"	158.60
BXA	3900-5121	1.65"	1.41"	.411"	3	4-5/8	2-3/4	5/8	1-5/8	5-9/16	7-5/16	10~15"	196.63
CXA	3900-5131	2.16"	1.68"	.565"	3-1/2	5-1/8	3	3/4	1-7/8	6-1/8	7-7/8	13~18"	265.80
CA	3900-5141	2.62"	2.21"	.493"	4	6-1/4	3-5/8	7/8	2-1/8	7	9	14~20"	403.96
DA	3900-5162	3.25"	2.72"	.600"	5	7-5/8	4-5/8	7/8	2-11/16	8-1/4	10-7/8	17~48"	1,067.47

Replacement Screws - For Aloris Type Turning & Facing Holders

- Replace worn or lost hold down screws.



FITS #7 HOLDERS

Item#	Series	Size	Price (F)	Item#	Series	Size	Price (F)
3900-5472	OXA	M6X16	1.34	3900-5473	OXA	M6X48	9.24
3900-5919	AXA	M8X20	1.34	3900-5474	OXA-T	M6X48	9.24
3900-5476	BXA	M8X30	1.34	3900-5475	AXA	M8X70	11.54
3900-5478	CXA	M10X28	1.34	3900-5477	BXA	M8X82	11.54
3900-5480	CA	M12X32	1.49	3900-5479	CXA	M10X93	13.86
3900-5482	DA	M12X32	2.17	3900-5481	CA	M10X104	13.86
				3900-5483	DA	M10X134	21.56

STUD FITS #7 HOLDERS

Item#	Series	Size	Price (F)
3900-5913	AXA	M8X70mm	4.11



NO. 16E - INDEXABLE THREADING & FACING HOLDERS

- Unique design allows you to use both sides for threading cut.
- Supplied with fully adjustable carbide chip breaker and carbide shims.
- Two triangular carbide inserts included.



Interchangeable with **Aloris®** and **DORIAN®** same series

Item#	Series	Description	Price (F)
3900-5259	AXA	Holder with TCMT-32.51 inserts	91.82
3900-5925	BXA	Holder with TCMT-32.51 inserts	137.10
6004-9031		TCMT-32.51 TiN Carbide Insert	5.83

QUICK-CHANGE TOOL HOLDERS

NO. 1 - TURNING & FACING HOLDERS

Interchangeable with **Aloris®** and **DORIAN®** same series

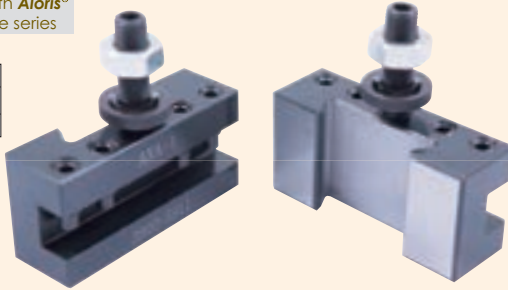
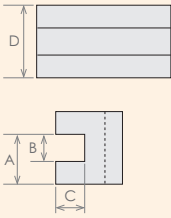

Item#	Series	(Inch)				Tool Bit Capacity	Price (F)
		A	B	C	D		
3900-5461	OXA	5/8	1/2	5/16	1	Up to 1/2	26.56
3900-5911	AXA	15/16	1/2	7/16	1-1/2	3/16~1/2	29.27
3900-5931	AXA-1S	1-3/64	5/8	9/16	1-1/2	1/4~5/8	29.27
3900-5261	BXA	1-1/8	5/8	1/2	1-3/4	1/4~5/8	34.56
3900-5934	BXA-1S	1-13/64	3/4	5/8	1-3/4	1/2~3/4	34.60
3900-5231	CXA	1-7/16	3/4	5/8	2-1/8	1/2~3/4	49.26
3900-5941	CA	1-11/16	1	3/4	2-1/2	1/2~1	65.37
3900-6001	DA	3-3/16	1-1/4	1	3-1/8	3/4~1-1/4	194.76

NO. 2 - BORING, TURNING & FACING HOLDERS

Interchangeable with **Aloris®** and **DORIAN®** same series

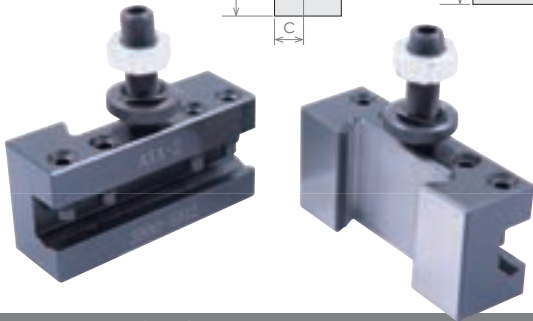
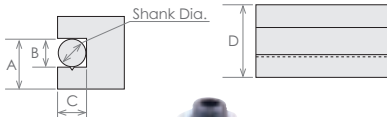

Item#	Series	(Inch)				Tool Bit Capacity	Shank	Price (F)
		A	B	C	D			
3900-5462	OXA	5/8	1/2	5/16	1	Up to 1/2	7/24	27.57
3900-5912	AXA	15/16	1/2	7/16	1-1/2	3/16~1/2	7/16	30.27
3900-5932	AXA-2S	1-1/32	5/8	9/16	1-1/2	1/4~5/8	1/2	30.02
3900-5262	BXA	1-1/8	5/8	1/2	1-3/4	1/4~5/8	1/2	34.56
3900-5935	BXA-2S	1-7/32	3/4	5/8	1-3/4	1/2~3/4	3/4	35.29
3900-5232	CXA	1-7/16	3/4	5/8	2-1/8	1/2~3/4	3/4	49.99
3900-5942	CA	1-11/16	1	3/4	2-1/2	1/2~1	13/16	69.28
3900-6002	DA	3-3/16	1-1/4	1	3-1/8	3/4~1-1/4	1	193.17

NO. 4 - HEAVY DUTY BORING HOLDERS

Interchangeable with **Aloris®** and **DORIAN®** same series

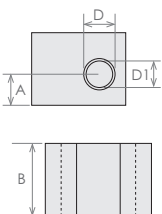

Item#	Series	Inside (Inch)				Price(F)
		A	B	D	D1	
3900-5464	OXA	1/2	1	1/2	5/12	39.61
3900-5203	AXA	3/4	1-1/2	3/4	5/8	39.06
3900-5204	BXA	1	2	1	3/4	47.40
3900-5233	CXA	1	2	1	3/4	72.09
3900-5206	CA	1-3/8	2-3/4	1-1/4	1	86.84
3900-6004	DA	1-9/16	3-1/8	1-1/2	1-1/4	239.25

NO. 5 - MORSE TAPER HOLDERS FOR DRILLING

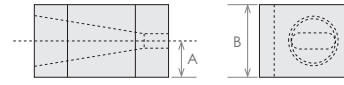

Item#	Series	Taper Hole	A	B	Price (F)
3900-5226	OXA	MT2	1/2	1-1/4	47.57
3900-5917*	AXA	MT 2	3/4	1-1/2	37.24
3900-5227*	BXA	MT 2	7/8	1-3/4	54.37
3900-5237*	CXA	MT 3	1	2	68.40
3900-5947*	CA	MT 3	1-1/4	2-1/2	68.07

*Limited Supply

NO. 53, 54, 55 - MORSE TAPER HOLDERS FOR DRILLING

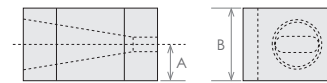

Item#	Series	Taper Hole	A	B	Price (F)
3900-5258	AXA	MT 3	3/4	1-1/2	61.88
3900-5228	BXA	MT 3	7/8	1-3/4	84.07
3900-5948	CA	MT 4	1-1/4	2-1/2	84.08

NO. 7 - UNIVERSAL PARTING BLADE HOLDERS



Item#	Series	Parting Angle	A	B	C	D	Price (F)
3900-5467	OXA	4°	13/16	1/2	1/8	1	30.27
3900-5468	OXA	0°	5/8	1/2	1/8	1	36.50
3900-5914	AXA	4°	13/16	1/2	3/16	1-1/2	41.82
3900-5264	BXA	4°	1	11/16	3/16	1-3/4	42.86
3900-5234	CXA	4°	1-3/16	3/4	3/16	2	71.52
3900-5944	CA	4°	1-7/16	7/8	1/4	2-1/2	80.49
3900-6007	DA	4°	1-3/4	1-1/8	1/4	2-3/4	200.28

See page 304 for parting blades

NO. 10 - KNURLING, TURNING AND FACING HOLDERS

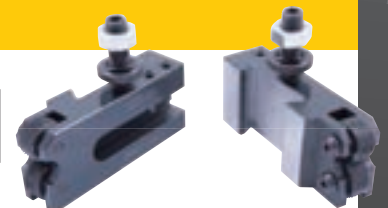
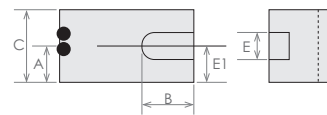

Item#	Series	(Inch)				Capacity Tool Bit	Price (F)	
		A	B	C	E	E1		
3900-5470	OXA	1/2	1-3/4	1-1/8	7/16	3/8	Up to 1/2	50.55
3900-5915	AXA	7/8	2-1/2	1-9/16	1/2	3/8	3/16~1/2	51.24
3900-5225	BXA	1	2-5/8	1-3/4	5/8	1/2	1/4~5/8	72.06
3900-5236	CXA	1-3/16	3-1/8	2	3/4	5/8	1/2~3/4	101.65
3900-5946	CA	1-7/16	3-3/4	2-1/2	1	3/4	1/2~1	85.80
3900-6010	DA	1-7/8	4-1/2	3-1/8	1-1/4	1	1/2~1-1/4	244.57

QUICK-CHANGE TOOL POSTS & HOLDERS

5PC MINI QUICK-CHANGE TOOL POST & HOLDER KIT

- Fits 7x10, 7x12 and 7x14 mini lathes
- No tools required to change tools
- Made of aluminum

- ACCEPT**
- Turning Holder: 1/4-3/8" Shank
 - Boring Holder: 3/8" Shank
 - Cut-off Blade Holder: 1/2"



Limited Supply!

Aluminum
3900-5350
\$72.74 (F)

KIT INCLUDES

Tool post, Mounting hardware, Two turning tool holders, a boring tool holder and a cut-off blade holder

40-POSITION QUICK-CHANGE TOOL POSTS

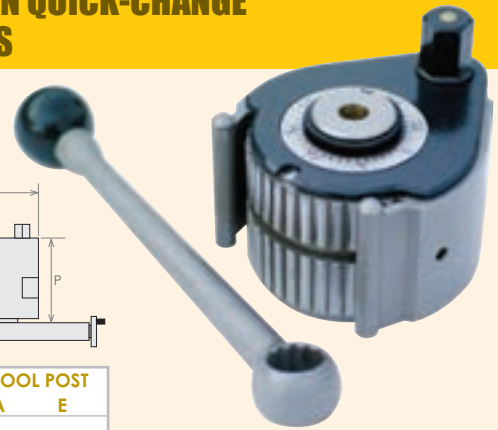
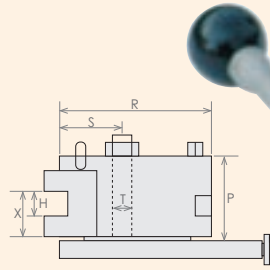

DIMENSION OF TOOL POST

	A	E
Max. Driving Power (HP)	3	6
R Maximum	4.13"	5.14"
S Maximum	2.07"	2.57"
P	1.83"	2.30"
T	0.79"	0.79"
H	0.83"	0.94"
X Minimum	1.18"	1.37"
X Maximum	1.61"	2.04"

All Holders are Interchangeable With Most of 40-Position Tool Post A, E & B

Item#	Series	Swing	Price (E)
3900-5310	A	6-13"	429.52
3900-5320	E	10-18"	529.22

RETROFIT GTN CUT-OFF AND GROOVING BLADES

- Used on Aloris and DORAIN Type Quick-Change Tool Holders
- High performance rates. No more re-grinding. Insert indexability.
- Also can use GTL, GTR inserts.



FOR GROOVING, PARTING-OFF AND CHAMFERING

INSERT IS NOT INCLUDED

Item#	Fits Holder	HSS Blade Reference	Blade Height	Cutting Width	Overall Length	Use Insert	Price (F)
3900-5971	AXA-7	P2	1/2	.087&.093"	4-11/32	GTN/R/L 2	49.40
3900-5973	BXA-7	P3N	11/16	.087&.093"	4-11/32	GTN/R/L 2	57.72
3900-5975	BXA-7	P3, T3	11/16	.120"	4-11/32	GTN/R/L 3	59.40
3900-5977	CXA-7	P3W	3/4	.120"	4-11/32	GTN/R/L 3	65.26
3900-5979	CA-7	P5X	7/8	.120"	5-29/32	GTN/R/L 3	66.97
3900-5981	CA-7	P5N	7/8	.160"	5-29/32	GTN/R/L 4	64.28

See page 139 for inserts

40-POSITION QUICK-CHANGE TOOL HOLDERS

All Holders are Interchangeable With Most of 40-Position Tool Post A, E & B



HOLDER A

HOLDER A - Cut-off				
Fit Post	Item#	Fits Blade Width	Holder Length	Price(E)
A	3900-5391	0.41"	3.16"	242.16
E	3900-5327	0.63"	4.00"	289.41
B	3900-5332	0.63"	4.75"	341.61



HOLDER B

HOLDER B - Boring, Turning & Facing				
Fit Post	Item#	Max. Holding Dia.	Holder Length	Price(E)
A	3900-5304	0.75"	3.54"	116.08
E	3900-5321	1.00"	4.00"	166.38
B	3900-5331	1.00"	5.00"	195.37

HOLDER D - Turning & Facing				
Fit Post	Item#	Max Holding Height	Holder Length	Price(E)
A	3900-5305	0.75"	3.54"	125.13
E	3900-5322	0.75"	4.00"	147.52
B	3900-5335*	1.25"	5.50"	224.69

*Limited Supply



HOLDER D

CUT-OFF BLADES, BEVELED



(Inch) Size(TxWxL)	HSS Item#	HSS Price (F)	5% COBALT Item#	5% COBALT Price (F)
3/32 x 1/2 x 4-1/2	2000-1002	6.83	2000-1102	10.16
3/32 x 5/8 x 5	2000-1003	8.79	2000-1106	11.78
1/8 x 1/2 x 4-1/2	2000-1000	7.43	2000-1110	10.58
1/8 x 3/4 x 5	2000-1004	9.88	2000-1114	14.09
1/8 x 7/8 x 6	2000-1005	13.57	2000-1118	19.68

HOLDER S - Heavy-Duty Boring & Drilling				
Fit Post	Item#	Holder Hole Dia.	Holder Length	Price(E)
E	3900-5323	1-5/8"	4.00"	243.62
B	3900-5336	1-5/8"	4.75"	274.08



HOLDER S

BUSHINGS For Holder S				
Fit Post	Item#	Taper	Holder Hole Dia.	Price(E)
A	3900-5307*	MT1	1-3/16"	35.20
A	3900-5308*	MT2	1-3/16"	37.93
E	3900-5326	MT2	1-3/16"	34.79
E	3900-5324	MT3	1-5/8"	45.38
B	3900-5338*	MT3	1-5/8"	48.43
B	3900-5339*	MT4	1-5/8"	51.38



*Limited Supply

KNURLING TOOLS & KNURLS

3K REVOLVING HEAD KNURLING TOOLS

- Machined ground steel in shiny black finish.
- Knurls are hob cut from high speed steel and heat treated.
- Provided with one pair each of fine, medium and coarse knurls.
- Replacement knurls are offered as a complete spare set for knurling tools.



Item#	Holder size W x H x L	Knurl Dimensions Dia. x Thickness x Hole	Price (F)
2220-0008	1/2 x 1-1/8 x 6-1/2"	3/4 x 3/8 x 1/4"	73.20
2220-0010	5/8 x 1-3/8 x 7-1/2"	3/4 x 3/8 x 1/4"	75.50

HSS KNURLING WHEELS

- High speed steel.
- Dimension: 3/4 (O.D.)x3/8 (Width)x1/4" (Hole)

SOLD AND SUPPLIED IN PAIRS



Pitch	Lines (Inch)	Diamond Item#	Price (F)	Straight Item#	Price (F)
Coarse	14	2220-0014	7.14	2220-0214	7.14
Medium	21	2220-0016	7.16	2220-0216	7.14
Fine	33	2220-0018	7.16	2220-0218	7.14

QUICK ACTING KNURLING TOOLS

NEW

- Fast set up knurling tool.
- Minimizes pressure on lathes
- Depth of knurling impression can be preset for production work.
- Finished with one set of medium diamond pattern knurls 3/4" x 3/8" x 1/4" (19 x 9.5 x 6.35)



Item#	Length	Shank H x W	Knurl Dimensions	Capacity	Price (F)
2220-0022	6"	1/2 x 5/8"	3/4x3/8x1/4"	1/16-2-1/4"	49.40
2220-0024	8-1/4"	5/8 x 3/4"	3/4x3/8x1/4"	1-1/2-4-1/2"	74.00

PIVOT HEAD KNURLING TOOL - Diamond

- Self-adjusting pivot head.
- Holder shank size: 4-1/2x1/2x1/2"
- Knurls Dimension:
3/4(Diameter)x3/8(Thickness)x1/4" (Hole).
- Produces medium diamond pattern.



VALUE
2226-0005
\$1100
(F)

HHIP
2220-0005
\$2165
(F)

SINGLE KNURLING TOOL

Features:

- Supplied with medium cut high speed steel knurl.
- Holder size 4 x 5/8 x 5/8.
- Straight (AA) pattern knurl.
- Each holder includes one medium pitch.



Knurl Size:
3/4x1/4x1/4"
2220-0004
\$1411
(F)

HSS KNURLING WHEEL 4 PAIR KIT

- High speed steel.
- Wheel Dimension:
3/4 (Diameter)x3/8 (Thickness)x1/4" (Hole)
- **Kit Includes:**
1 Pair of Diamond Coarse (14 lines/Inch),
Diamond Medium (21 Lines/Inch),
Diamond Fine (33 Lines/Inch)
& Straight Medium (21 Lines/Inch)



4 PAIR KIT (8pcs)
2220-0030
\$2735
(F)

SELF ADJUSTING KNURLING TOOLS

NEW

- Machined ground steel in shiny black finish.
- Knurls are hob cut from high speed steel and heat treated.
- Provided with one pair of medium knurls.
- Replacement knurls are offered as a complete spare set for knurling tools.



Item#	Holder size W x H x L	Knurl Dimensions Dia. x Thickness x Hole	Price (F)
2220-0027	1/2 x 1-1/8 x 6-1/2"	3/4 x 3/8 x 1/4"	41.40
2220-0029	5/8 x 1-3/8 x 7-1/2"	3/4 x 3/8 x 1/4"	38.00

MORSE TAPER TAILSTOCK TURRETS

- Taper: Morse Taper.
- Fill tool socket with 5/8" diameter.
- Head Diameter: 2-1/2".
- Will save time quick change machining operation within seconds.



Item#	Taper	Drawbar End	Price (E)
3900-4910	MT 2	3/8"~16	149.46
3900-4909	MT 3	3/8"~16	206.25

MT TO JT REVOLVING TAILSTOCK ARBORS/ADAPTERS

- This is a "live" drill chuck adapter with smooth, sealed bearing for the tailstock.
- Use it to mate with a JT drill chuck and support small diameter work where a live center is not practical.
- The shank is 2 or 3 Morse taper.



Item#	Taper	Drawbar Thread	Price (F)
3906-4922	MT 2 x JT2	M10	42.14
3906-4925	MT2 x JT3	M10	42.14
3901-4910	MT2 x JT33	M10	89.06
3906-4928	MT3 x JT2	M12	42.14
3906-4932	MT3 x JT3	M12	42.14

REVOLVING TAILSTOCK BACKPLATES For Lathe Chucks

- Used for calibrate or support workpiece during processing.
- Three ball bearings for heavy duty load and relatively high speed.
- 3 hole chuck mounting pattern is pre-drilled.

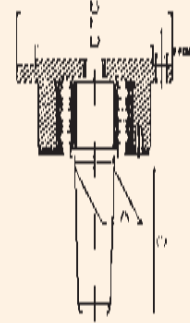
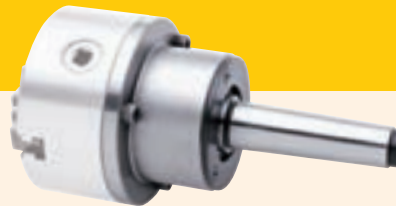

LATHE CHUCK OPTIONAL

Item#	Shank Taper	A	B	(mm) C	D	E	Max Load (lbs)	T.I.R. (Inch)	Speed RPM	Price (E)
3900-6022	MT2	17.78	80	64	55	66	1100	.0002	4000	229.54
3900-6021	MT2	17.78	100	64	72	84	1100	.0002	2500	216.35
3900-6023	MT3	23.83	80	81	55	66	1760	.0002	4000	206.67
3900-6024	MT3	23.83	100	81	72	84	1760	.0002	2500	296.22
3900-6024	MT4	31.27	100	103	72	84	2200	.0002	4000	296.22
3900-6025	MT5	44.40	125	130	95	108	3300	.0004	3500	462.74
3900-6030	MT4	31.27	125	103	95	108	2200	.0004	4000	437.25
3900-6031	MT5	44.40	160	130	130	142	3300	.0004	3500	644.93

2MT MORSE TAPER SHANK 3 & 4-JAW SELF-CENTERING CHUCKS

- Steel body-hardened and ground scroll and pinions
- Hardened and ground MT spindle
- Supplied with chuck wrench.
- 3/8-16 threaded drawbar.
- 2 MT shank.
- T.I.R. 0.0006".

3", 3 JAW
3900-4706
\$165.33 (E)

3", 4 JAW
3900-4707
\$223.35 (E)

2 SETS OF SOLID STEEL JAWS (INTERNAL AND EXTERNAL)



3900-4706 SHOWN

DEAD CENTERS -Full, Half, Steel Or With Carbide Tip

- Made of tool steel, hardened and ground.
- +/- .0002" TIR

Carbide Tip Shown

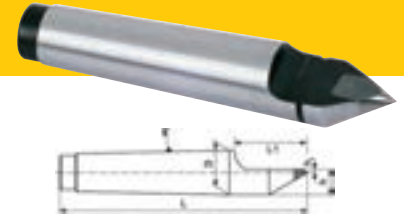
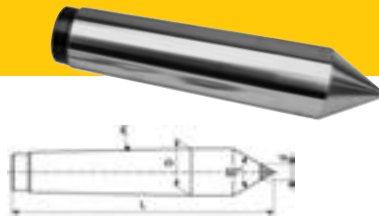
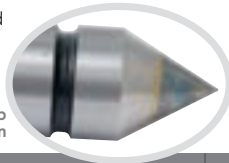

Morse Taper	(mm)							Full Point				Half Point			
	h1	h	d	D	L1	L	Accuracy	Steel Item#	Price (F)	Carbide Tipped Item#	Price (F)	Steel Item#	Price (F)	Carbide Tipped Item#	Price (F)
1 MT	1.5	5.5	8	12.065	35	80	0.01	3900-5051	10.57	3900-5056	15.47	3900-6051	11.97	3900-6056	21.62
2 MT	2	6	8	17.78	43	100	0.01	3900-5062	13.68	3900-5057	17.63	3900-6052	15.75	3900-6057	22.70
3 MT	3	9	12	23.825	57	125	0.01	3900-5063	16.48	3900-5058	25.80	3900-6053	20.09	3900-6058	25.50
4 MT	5	12.5	15	31.267	70	160	0.01	3900-5064	24.24	3900-5059	36.71	3900-6054	26.67	3900-6059	35.02
5 MT	7	16	18	44.399	90	200	0.01	3900-5065	36.80	3900-5060	62.04	3900-6055	46.92	3900-6060	60.45

ECONOMY LIVE CENTERS

- Central spindle is made of hardened alloy steel and ground for high accuracy.
- Precision high quality bearings, combination of ball bearing and thrust bearing.
- Dustproof seal on the front end.

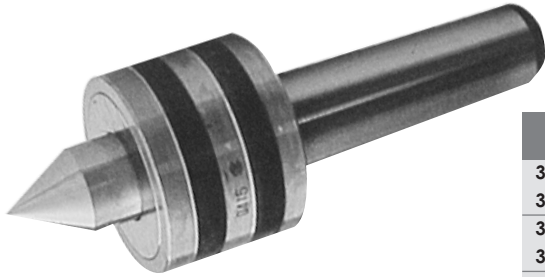

Item#	Morse Taper	d	D	(Inch)			Accuracy Load	Radial Load (N)	Max. RPM	Price (F)
				D1	L1	OAL				
3900-5001	1	.71	1.3	.475	.79	4.33	.0004	900	4000	31.95
3900-5002	2	.98	1.8	.700	1.02	5.71	.0004	1500	3500	39.60
3900-5003	3	1.10	2.1	.938	1.18	6.69	.0004	2000	3000	44.46
3900-5004	4	1.26	2.4	1.231	1.37	8.10	.0004	3200	2500	51.77
3900-5005	5	1.77	3.0	1.748	1.77	10.0	.0006	6300	2000	82.77
3900-5006	6	2.95	4.9	2.494	2.70	14.25	.0006	10000	1200	404.93

MEDIUM DUTY LIVE CENTERS

- With 60° included angle.
- Made of hardened steel and ground to high accuracy.
- The central spindle lengthened to reduce vibration.
- Two special designed high-quality ball bearing and thrust bearings.
- Complete protection of bearings from the ingress of coolant, dirt or swart.
- Slim body design.



CONCENTRICITY WITHIN .0002"

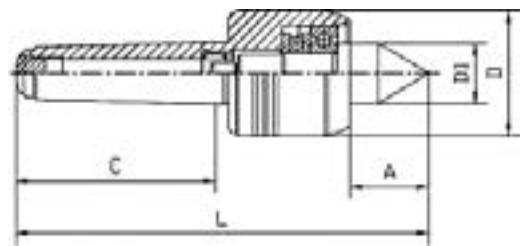

Item#	Morse Taper	d1	D	(Inch)			Load Rate lbs.	Max. RPM	Price (F)
				A	C	L			
3900-5029	2	0.86	1.65	1.12	4.58	5.70	330	3500	48.10
3900-5030	3	0.90	1.86	1.12	5.73	6.85	660	3000	63.36
3900-5040	4	1.02	2.17	1.25	6.95	8.20	990	2500	69.12
3900-5041	5	1.38	2.70	1.90	8.60	10.50	1760	2000	102.81

SUPER DUTY HIGH PERFORMANCE LIVE CENTERS

- Combination of needle roller, thrust ball and deep groove ball bearings.
- Central spindle is made of hardened alloy steel and ground.
- Oil filler in the head for maintain the internal bearings to extend the life time.

CONCENTRICITY WITHIN .0002"

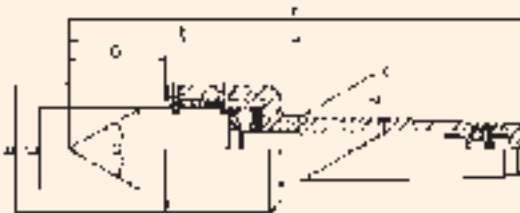

Item#	Morse Taper	(mm)						Load Rate lbs.	Max. RPM	Price (F)
		A	B	C	D	E	F			
3900-6074	2	17.78	36	22	26	68.5	126	660	5500	139.20
3900-6075	3	23.83	47	30	35	93.0	166	880	4500	180.45
3900-6076	4	31.27	55	35	40	104.0	197	2640	4000	181.58
3900-6078	5	44.40	70	45	51	134.5	246	4400	3000	256.15

SMALL HEAD LIVE CENTERS - REVOLVING BODY STYLE

- Revolving body turn vs common head turns.
- The center adopts the combinatin of deep groove ball bearings.
- Small head can be used in different processing demands.
- Applicable to medium high speed light load applications.
- The head is made of alloy steel and hardened to HRC 58-62.
- Dustproof sealed.

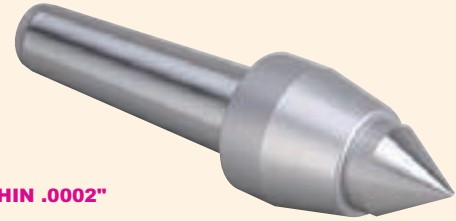
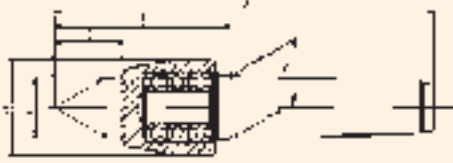

CONCENTRICITY WITHIN .0002"

Item#	Morse Taper	A	B	(mm) C	D	E	F	Radial Load (lbs.)	Max. RPM	Price (F)
3900-6101	1	12.07	32	16	21	54.5	108	88	4000	49.11
3900-6102	2	17.78	40	22	26	68	132	264	3500	49.11
3900-6103	3	23.83	45	26	32	83	164	550	3000	54.68
3900-6104	4	31.27	48	30	34	93.5	188	770	2500	75.30
3900-6105	5	44.40	68	45	50	118.5	248	1100	2000	102.79

LIVE CENTERS - REVOLVING BODY STYLE

- One piece central spindle and revolving body is made of hardened alloy steel and ground for high accuracy.
- Precision high quality bearings, combination of ball bearing and thrust bearing.
- Dustproof sealed.



CONCENTRICITY WITHIN .0002"

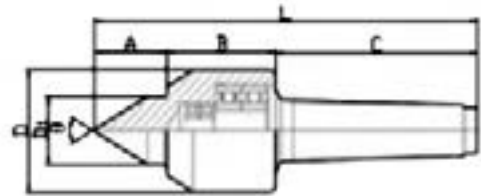

Item#	Morse Taper	A	B	(mm) C	D	D1	L	Accuracy Load	Radial Load (lbs.)	Max. RPM	Price (F)
3900-6093	3	33	56	88	53	28	177	.0002"	700	6000	69.09
3900-6094	4	40	60	108	63	35	211	.0002"	1200	5000	87.57
3900-6095	5	50	62	138	73	45	250	.0003"	1800	3000	111.64

ULTRA PRECISION HEAVY DUTY LIVE CENTERS

- Triple bearing design.
- Machined from one piece of forging, hardened and precisely ground.
- Accuracy: less or equal .0002" TIR.
- Ultra precision radial bearing reduces run out to minimum after much use.



CONCENTRICITY WITHIN .0002"

Item#	Morse Taper	A	B	(mm) C	D	D1	L	Load Rate lbs.	Max. RPM	Price (F)
3900-6082	2	31	48	69	46	20	147	770	6300	106.32
3900-6083	3	39	55	86	53	30	180	1200	5000	127.86
3900-6084	4	42	62	108	63	32	208	1760	3800	196.34
3900-6085	5	49	71	136	83	40	256	4400	3000	301.11

LIVE CENTERS

7PC MULTI-SHAPE LIVE CENTER SETS

- Made of high grade tool steel hardened and ground.
- Precision needle bearings used for high accuracy with long life.
- Accuracy guaranteed to 0.0012-0.0039" at center head.
- Less heat is generated due to spring plate used.
- Complete with fitted case.

Item#	Morse Taper	Thrust Load lbs.	Origin	Price (E)
3906-5019	MT1	330	India	107.25
3906-5020	MT2	330	India	124.87
3900-5021	MT3	900	China	182.24
3900-5022	MT4	1200	China	177.90
3900-5023	MT5	1600	China	217.86



SET INCLUDES:
MORSE TAPER LIVE CENTER,
7 INTERCHANGEABLE TIPS, WRENCH

INTERCHANGEABLE POINT LIVE CENTER KITS

- Used for CNC machines.
- Fine adjustment for better grip.
- Made of hardened tool steel and ground to high accuracy.
- Two special designed high-quality bearings.
- Can be lubricated through a hole on head for smooth operation and longer bearings life.
- Heat treated to HRC 60.

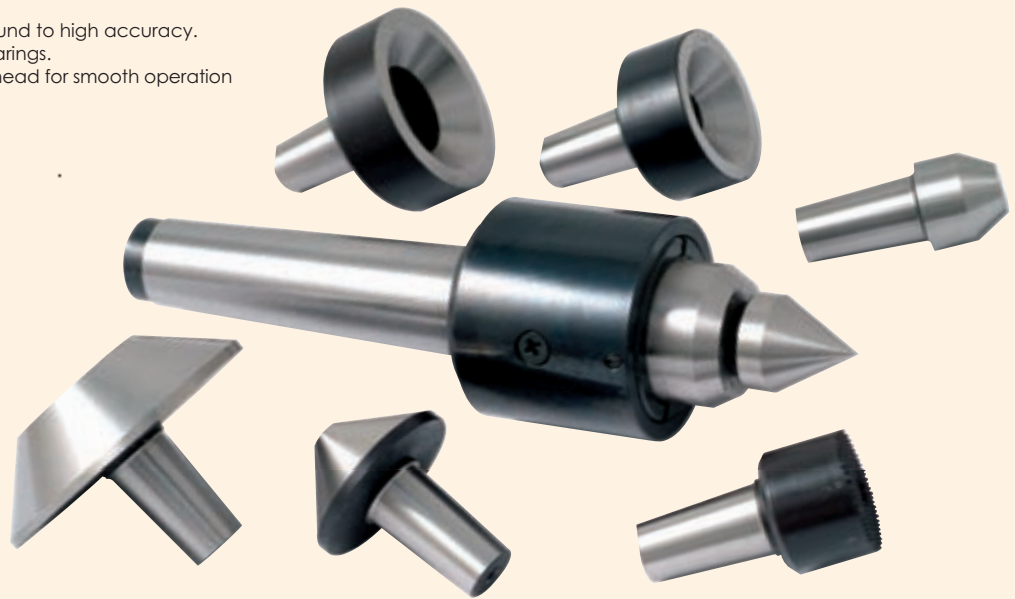

KIT INCLUDES

- Live Center Body
- 3 of Bull Nose Point
- 2 of Cone Shape Point
- 1 Serrated Point
- 1 Wrench Tool

Item#	Morse Taper	A	B	C	(mm) D	E	F	G	Load Rate kg	RPM	Accuracy	Price (F)
3900-5052	2	17.780	36	22	10.5	68.5	110	10	300	5500	0.01	262.36
3900-5053	3	23.825	47	30	15	93	145	15	400	4500	0.01	357.30
3900-5054	4	31.267	55	35	16	104	172	20	1200	4000	0.01	348.03
3900-5055	5	44.399	70	45	20	134.5	216	25	2000	3000	0.02	400.28

POINT DIMENSIONS:



Unit: Inch

Morse Taper	d	l	A			B			C			D				E				F				G	
			D	D1	L	D	D1	L	D	D1	L	D	D1	D2	L	D	D1	D2	L	D	D1	L	D	L	
2	.380	.630	.60	--	1.51	1.13	.201	1.38	1.73	0.80	1.40	1.12	0.77	.22	1.40	1.52	1.10	.55	1.39	.59	.06	1.38	.88	1.38	
3	.590	.984	.79	.019	1.97	1.42	.236	1.77	2.48	1.30	1.77	1.42	1.10	.47	1.77	1.77	1.50	.87	1.77	.79	.10	1.77	.98	1.77	
4	.784	1.181	.98	.019	2.36	1.77	.393	2.09	2.76	1.38	2.09	1.77	1.46	.67	2.09	2.48	2.09	1.18	2.09	.98	.20	2.09	1.26	2.09	
5	.984	1.496	1.26	.039	2.87	2.20	.551	2.56	3.15	1.50	2.56	2.20	1.73	.79	2.56	2.78	2.36	1.42	2.56	1.26	.20	2.56	1.77	2.56	

HEAVY DUTY BULL NOSE LIVE CENTERS

- Bull nose live centers are typically used in applications where the center hole is a large bore or when the application calls for the machining of pipe or other cylindrical components such as hydraulic cylinders, manufacturers of power generation components, and pipe manufacturers.
- Bull nose live centers are constructed with larger bearings to carry these heavy loads.
- The strength and alignment of the fully supported bull nose head provides longer center life.
- The rigidity of this live center helps dampen vibration and resist chatter.

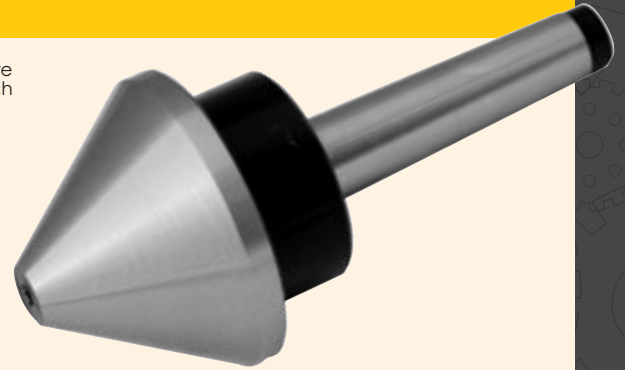
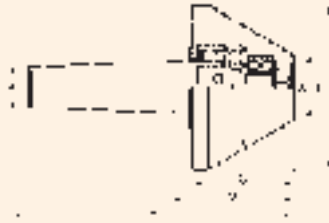

Item#	Morse Taper	A	D	(Inch) B	α	L	Load Rate Lbs.	Drawbar Threads	Price (F)
3900-5010	MT2	0.50	2.49	1.42	70°	5.37	440	3/8~16	134.75
3900-5011	MT3	0.75	3.10	1.66	70°	6.75	440	3/8~16	160.38
3900-5015	MT3	1.25	4.00	2.06	75°	7.15	880	3/8~16	146.74
3900-5008	MT3	1.25	5.00	2.40	75°	7.65	880	3/8~16	206.16
3900-5009*	MT3	1.38	6.00	4.06	75°	7.24	1320	3/8~16	233.18
3900-5014	MT4	1.25	4.00	2.06	75°	8.11	1760	5/8~11	170.40
3900-5012	MT4	1.37	5.05	2.45	75°	7.60	1760	5/8~11	231.26
3900-4998	MT4	1.38	6.00	4.11	75°	8.15	1760	5/8~11	238.70
3900-4999	MT4	1.57	8.00	4.82	75°	8.86	3520	5/8~11	357.08
3900-5016	MT5	1.26	4.75	2.40	75°	9.09	3000	3/4~16	346.50
3900-5013	MT5	1.38	6.00	3.20	75°	8.75	3000	3/4~16	303.90
3900-5017	MT5	1.57	8.00	4.84	75°	9.92	3000	3/4~16	440.40
3900-5018	MT5	2.24	10.00	5.96	75°	10.00	2640	3/4~16	589.86
3900-5019	MT6	1.57	8.00	4.25	75°	12.60	3500	1~8	412.50

*Limited Supply

Pro-Series HIGH SPEED CNC LIVE CENTERS



HHIP PRO-SERIES

- With 60° included angle.
- Designed for high speed on N/C lathe
- Point is high-carbon alloy steel and heat treated.
- Bearings permanently lubricated
- Body is hardened for extra strength and extra rigidity

Limited Supply!

8,000RPM
≤ .0002" TIR

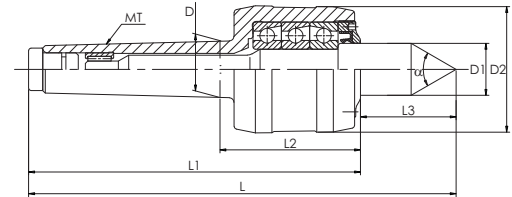

Item#	Morse Taper	D	D1	D2	(Inch) α	L	L1	L2	L3	Max. RPM	Weight lbs	Price (E)
3901-7002	2	0.700	0.71	1.7	60°	5.5	4.5	1.91	0.96	8000	1.9	143.14
3901-7003	3	0.938	0.87	2.1	60°	7.1	5.5	2.34	1.59	8000	2.9	144.04

Pro-Series MEDIUM-DUTY CNC LIVE CENTERS

- With 60° included angle.
- Designed for long life, medium duty on N/C lathe.
- Point is high-carbon alloy steel and heat treated.
- Bearings permanently lubricated.
- Body is hardened for extra strength and extra rigidity.

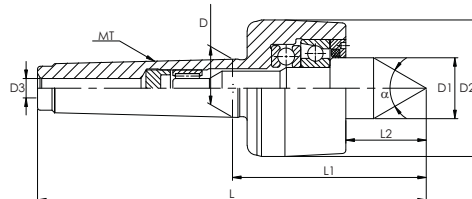

Limited Supply!

Item#	Morse Taper	D	D1	D2	(mm) α	L	L1	L2	Max. RPM	Load Rate Lbs.	Weight Lbs.	Price (E)
3901-7013	3	23.83	24.8	56	60°	171	91	45	4000	660	2.2	110.00
3901-7015	5	44.40	40.7	83	60°	265	135	73	2500	3300	8.8	197.44

≤ .0003" TIR

HHIP PRO-SERIES

LIVE CENTERS

PRECISION EXTENDED POINT LIVE CENTERS

- Suitable for medium/high speed application
- Ball bearing construction

- Made of alloy steel and hardened to 58-62 RC
- Dustproof seal on the front end to prevent the entry of cutting fluid and dust



≤ .0002" TIR

Item#	Morse Taper	Nose Length	OAL	Max. RPM	Load Rate (Lbs)	Price (F)
3900-5024	2	1.16"	6.14"	5000	260	87.30
3900-5025	3	1.25"	7.25"	4000	660	107.25
3900-5026	4	1.44"	8.45"	3500	1100	155.23
3900-5027	5	1.78"	10.35"	2500	2200	195.58

HIGH SPEED CNC LIVE CENTERS

- With 60° included angle.
- Made of hardened tool steel and precision ground.
- Two special designed high-quality bearings.
- Complete protection of bearings from the ingress of coolant, dirt or swarf.
- Spindle heat treated to HRC 60.

≤ .0002" TIR

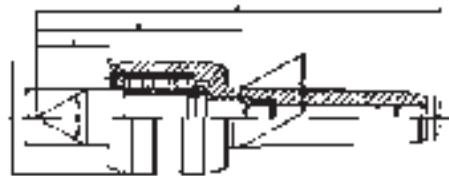

Morse Taper	Max. RPM	Load Rate Lbs.	Type A				Type B			
Item#	Nose Length	OAL	Price (F)	Item#	Nose Length	OAL	Price (F)			
3900-5037	1.16"	6.5"	174.63	3900-5047	1.75"	7.3"	196.45			
3900-5038	1.48"	8.2"	234.79	3900-5048	2.00"	9.0"	272.65			
3900-5039	1.81"	10.0"	293.90	3900-5049	2.50"	10.8"	330.40			

Pro-Series HIGH SPEED CNC LIVE CENTERS

- With 60° included angle.
- Designed for long life, high speed on N/C lathe
- Point is high-carbon alloy steel and heat treated.

- Bearings permanently lubricated
- Body is hardened for extra strength and extra rigidity

≤ .0002" TIR

HIP PRO-SERIES

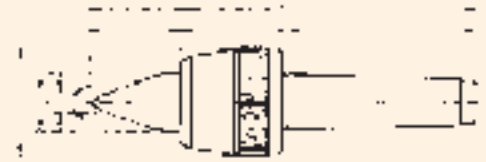

MADE IN TAIWAN

Item#	Morse Taper	Type	A	B	C	D	(Inch) D1	b	OAL	d1	Load Rate lbs.	Max. RPM	Weight lbs	Price (E)
3900-5033	3	A	1.54	2.17	3.39	2.09	1.18	---	7.09	0.47	200	4000	2.8	274.46
3900-5034	4	A	1.65	2.44	4.25	2.48	1.26	---	8.35	0.47	360	3000	4.8	274.46
3900-5035	5	A	2.24	2.80	5.35	3.27	1.57	---	10.40	0.71	800	2500	9.5	510.13
3900-5043	3	B	1.77	2.17	3.39	2.09	1.18	0.393	7.32	0.47	200	4000	2.8	294.45
3900-5044	4	B	2.05	2.44	4.25	2.48	1.26	0.472	8.74	0.47	360	3000	4.8	294.45
3900-5045	5	B	2.64	2.80	5.35	3.27	1.57	0.551	10.79	0.71	800	2500	9.7	554.60

HEAVY-DUTY PRECISION BENCH CENTERS

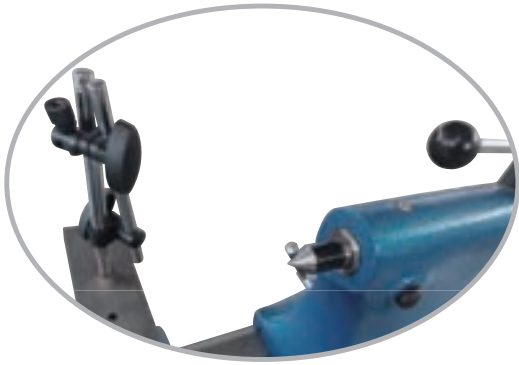

- Centers are hardened and precision ground.
- Quick-release centers.
- Hand scraped ways, adjustable gibbs.
- MT2 dead center.
- Heavy duty adjustable indicator holder included and accepts most of AGD indicators.
- Head stock can be adjusted lengthwise and locked securely with special lever type handle.

Limited Supply!

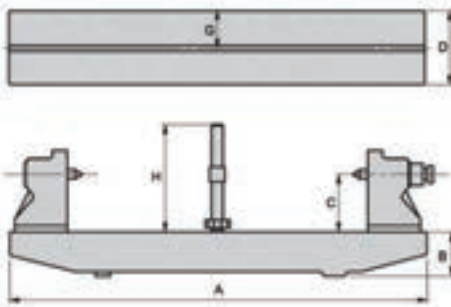

Item#	OAL A	Center to Center	Max. Swing C	B	D	G	H	Accuracy Run-out	Weight (Lbs.)	Price (F)
4401-0069	21	7.78"	3.9"	4.33"	4.33"	2.16	8.7"	0.0002"	78	574.75
4401-0072	29	11.8"	6.7"	6.1"	5.51"	2.80"	8.7"	0.0002"	125	917.13

HEAVY-DUTY PRECISION BENCH CENTERS

- Centers are hardened and precision ground.
- Quick-release centers.
- Hand scraped ways, adjustable gibbs.
- MT2 live center.
- Heavy duty adjustable indicator holder included.
- Indicator holder included and accepts most of AGD indicators.
- Head stock can be adjusted lengthwise and locked securely with special lever type handle.

23.5"
(Center to Center)
4401-0024
\$1,592.86
(E)

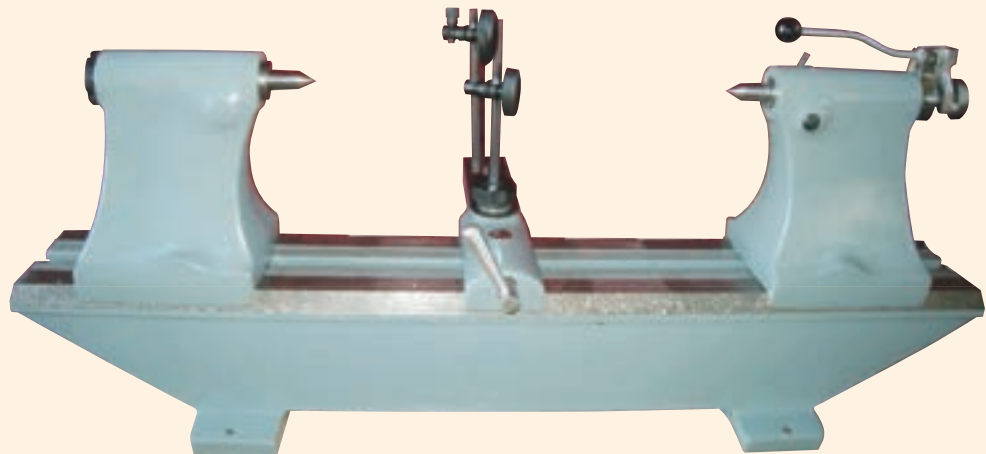
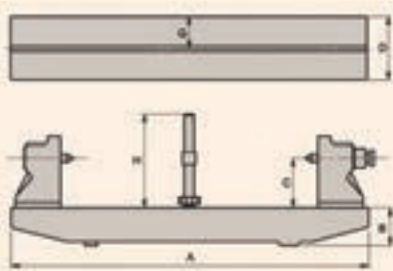

Item#	OAL A	Center to Center	Max. Swing C	B	D	G	H	Accuracy Run-out	Weight (Lbs.)	Price (E)
4401-0023	36"	19"	5.25"	6.3"	5.5"	2.76"	7.9"	0.00015"	240	1,244.38
4401-0024	40"	23.5"	5.25"	6.3"	5.5"	2.76"	7.9"	0.00015"	440	1,592.86
4401-0025	56"	39"	8.50"	6.3"	5.5"	2.76"	7.9"	0.00018"	620	1,551.10

CONCENTRICITY CHECKERS

Pro-Series PRECISION CONCENTRICITY CHECKER



- Suitable for measuring concentricity, roundness and deviation with high accuracy.
- Metal base can be easily attached a magnetic base
- Measuring Range: 0.059~0.980"/1.5~25 mm diameter.
- Device Dimension: 10.5 L x 4.5 W x 5" H.
- Accuracy: 0.00008"/ 0.002mm.
- Max. length to hold a parts: 4"

4401-1001
\$1,309⁸¹
(E)

MADE IN
TAIWAN



MINI UNIVERSAL MAG BASE
W/FINE ADJUSTMENT



Accuracy: 0.00008"/ 0.002mm.

.0005 GRADUATION
0-0.03" RANGE TEST INDICATOR

Base & Indicator Kit
4400-0027
\$138⁴⁹
(E)
With Fitted Case



SHOWN WITH OPTIONAL KIT

LARGER CAPACITY UNIVERSAL CONCENTRICITY GAGE/CHECKER

NEW

- Concentricity Gage allows you to measure the runout of parts internal and external.
- Diameter Capacity: 0.394~1.969"(10~50 mm)
- Length Capacity: 6"
- Device Dimension: 360 (length) X 150 (width) X 151mm (height)
- Accuracy: 0.00012"/ 0.003mm.
- Directional Drive Hand Wheel pushes the parts into the stop for accurate repeatable readings with equal pressure.
- Two position wheels made from solid steel

- Precision Drive Wheel has a perfect ratio to push the parts down.
- Ultra high precision ball bearings provide friction free movement.
- Heavy duty base mounted fine adjustable sliding test indicator holder. Will accept test indicator with dovetail slot.
- Adjustable mechanical arm stop holds the arm up for one handed operation.
- Two master setting pins included: 10 & 50mm diameter

Accuracy: 0.00012"/ 0.003mm

4401-1011
\$2,165⁵⁰
(E)



.0005 GRADUATION
0-0.03" Range Test Indicator
4400-0010
\$51¹²
(F)

UNIVERSAL CONCENTRICITY GAGE/CHECKERS

SINGLE INDICATOR HOLDER

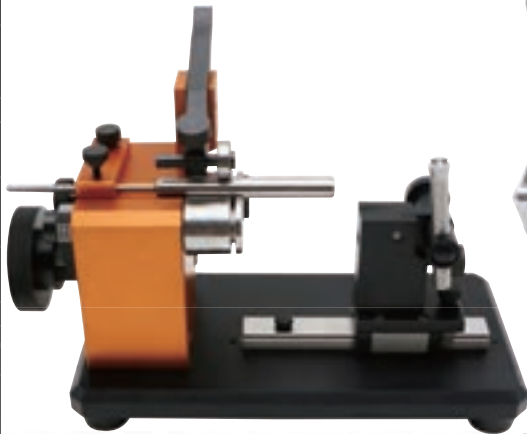

- Concentricity Gage allows you to measure the runout of parts internal and external.
- Diameter Capacity: 0.157-0.980"(4-25 mm)
- Length Capacity: 4"
- Device Dimension: 216 (length) X114 (width) X 130mm (height)
- Weight: 10.90 lbs.
- Accuracy: 0.00012"/ 0.003mm.
- Directional Drive Hand Wheel pushes the parts into the stop for accurate repeatable readings with equal pressure.
- Two position wheels made from solid steel
- Precision Drive Wheel has a perfect ratio to push the parts down.
- Ultra high precision ball bearings provide friction free movement.
- Heavy duty base mounted fine adjustable sliding test indicator holder. Will accept test indicator with dovetail slot.
- Adjustable mechanical arm stop holds the arm up for one handed operation.
- Two master setting pins included: 4 & 10mm diameter

Accuracy: 0.00012"/ 0.003mm.

Single Indicator Holder
4401-1006
\$1,739³⁸
(E)

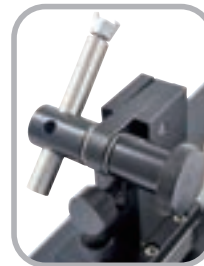
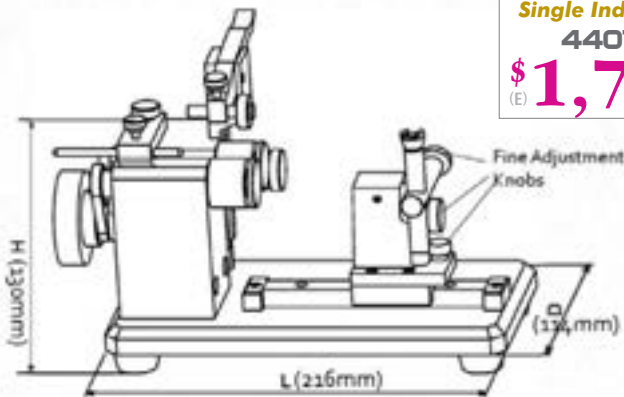

SHOWN WITH OPTIONAL INDICATOR(not included)

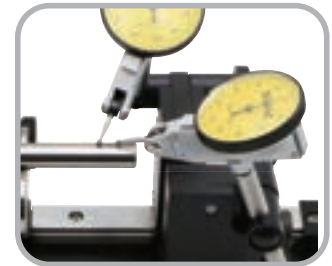

DOUBLE INDICATOR HOLDER

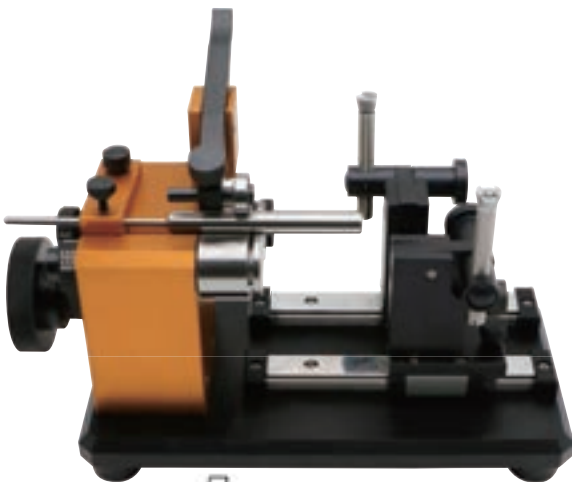

Double Indicator Holder
4401-1008
\$1,960⁷⁵
(E)

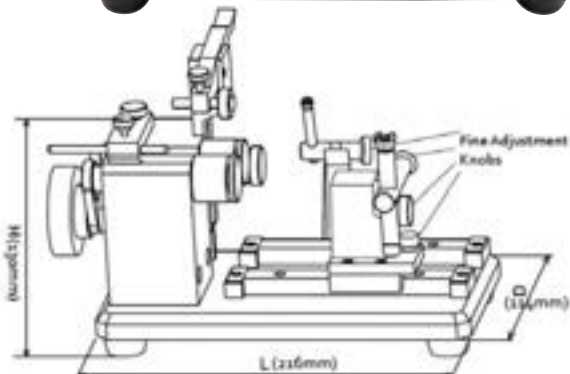

.0005 GRADUATION
0-0.03" Range Test Indicator
4400-0010
\$51¹²
(F)



PUNCH FORMERS & GRINDERS

MACHINE TOOL ACCESSORIES

Pro-Series 2-WAY ULTRA PRECISION PUNCH FORMER

- FINE-TUNING function punch former has stronger compact structure for longer durability.
- Vertical & horizontal adjustment function is particularly suitable for oval punch grinding.
- V-block clamping can accurately stabilize workpiece and vertical fine-tuning can make setting center easy
- High precision double bearings help achieve higher accuracy, rigidity and stability
- Stopper design in position slot allows for easy & precisely stabilization for polygonal punches
- Dust-proof and water resistance

3800-5007
\$2,927.52 (E)

MADE IN TAIWAN

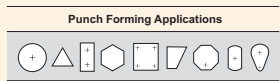

HHIP PRO-SERIES

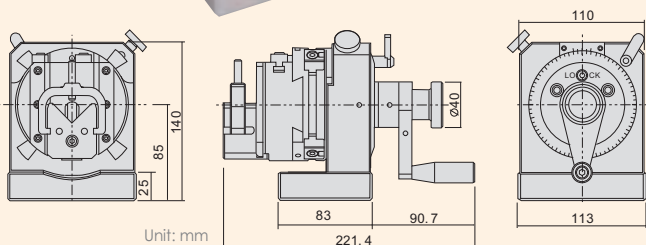

SPECIFICATIONS

Center Height	3.35 +/- 0.02", 85 +/- 0.5mm
Clamping Dia. Range of V-block.....	0.12~1.18"/ 3~ 30mm
Travel of V-block.....	1.77"/ 45mm
Slide plate horizontal Movement.....	+/- 0.71"/18mm
Indexer Number of tooth & Accuracy.....	24, 15 deg. +/-10"
Clamping Accuracy (50mm).....	0.0002"/ 0.005mm

ER COLLET PUNCH FORMER

- Clamps workpiece quickly and steadily when processing.
- Clamping diameter: .0787~.787".
- Utilized with ER32 spring collet.

3800-6808
\$988.00 (E)



INCLUDES: 7PC ER-32 COLLET SET:
1/8, 1/4, 5/16, 3/8, 1/2, 5/8, 3/4

Pro-Series PRECISION PUNCH GRINDER

- Can be used on the surface of grinding machine for round punches (0.12" ~ 1.18" dia.).
- Punches can be ground by putting among three rollers of punch grinder without checking the center.
- Accuracy of Roller (Turning Right or Left): 0.0002"
- Accuracy of Point A (Turning): 0.000197"
- Accuracy of Point B (Turning): 0.00031"

HHIP PRO-SERIES

3600-0037
\$477.40 (E)

MADE IN TAIWAN

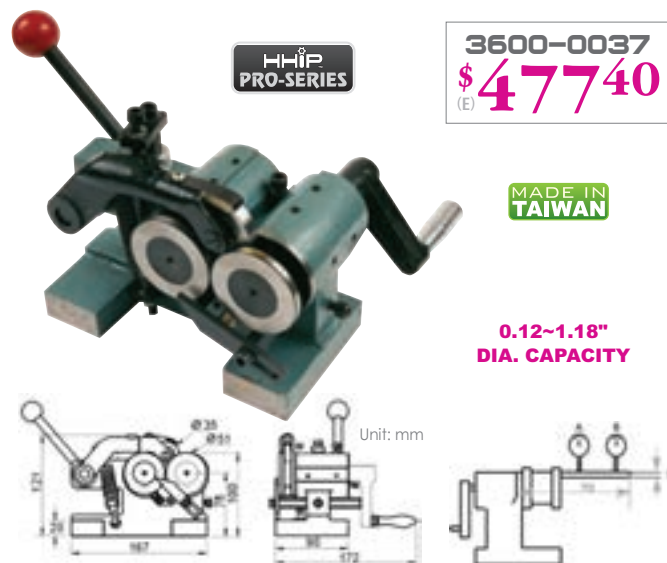

0.12~1.18"
DIA. CAPACITY

Pro-Series PRECISION SMALL PUNCH GRINDER

- Punch grinder can be placed on the bed of surface grinder for automatic precision cylindrical grinding.
- Punch grinder rollers are used to adjust the workpiece before grinding.
- Workpiece is turned with a crank handle.

SPECIFICATIONS

Accuracy of the rollers:.....	within 0.0002"
Diameter of punches can be ground:.....	0.020~0.236"/0.5~6.0mm
Net Weight:.....	6 lbs.

0.020~0.236" DIA. CAPACITY

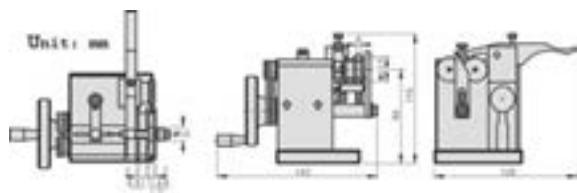

HHIP PRO-SERIES

3800-5150
\$665.50 (E)

MADE IN TAIWAN

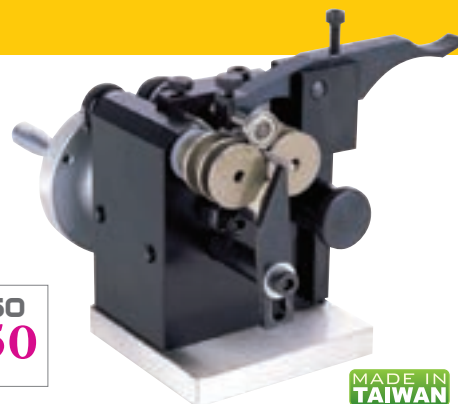

PUNCH FORMERS & RADIUS DRESSERS

Pro-Series PUNCH FORMER & RADIUS DRESSER

- For concave and convex radius.
- Hardened tool steel construction.

3600-0371
\$1,418⁵⁶
(E)

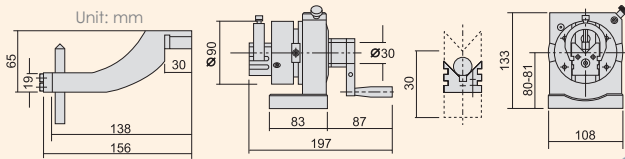

HHIP PRO-SERIES

SPECIFICATIONS

Max. dia. workpiece.....	1-1/4"
V-block.....	1-3/16"
Tangential travel (either side of center).....	25/32"
V-block adjusting system.....	rack & pinion
Center height.....	3-1/2"
Indexing div.....	24 every 15L ±10 seconds
Roundness.....	0.0001"
Parallelism.....	within .0001" in 4"
Squareness.....	within .0002" in 4"
Graduation.....	.360°
Max. Convex/Concave.....	1.89/3.94"
Min. Convex/Concave.....	.0012

Punch forming applications



Grinding wheel dressing application



MADE IN TAIWAN



REPLACEMENT DIAMOND ON PAGE 319

Pro-Series VISI - DRESS RADIUS AND ANGLE DRESSER

- 1° Vernier markings for dressing angles.
- Magnification through hole in the spindle, makes it possible to see how to dress the form on the grinding wheel.
- Dresser is tested and guaranteed for accuracy.

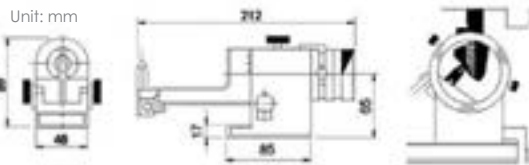

3900-0060
\$1,175⁶⁸
(E)

HHIP PRO-SERIES

SPECIFICATIONS

Overall Height.....	4"
Length.....	8-1/4"
Swing Arm.....	180°
Max. Size Grinding Wheel.....	8"
Max. Outside Radius (on wheel approx.).....	5/8"
Max. Inside Radius (on wheel approx.).....	1"
Spindle.....	1" O.D.
Weight.....	11 lbs



REPLACEMENT DIAMOND ON PAGE 319



MADE IN TAIWAN

Pro-Series UNIVERSAL WHEEL DRESSER

GRINDING WHEEL APPLICATIONS



- Adaptable on surface grinding machine and universal tool grinder for dressing grinding wheels into various shapes.
- Extremely accurate.

HOW TO CALCULATE

$H = L = "O" R$
 H - Distance between two locating pins (as picture shows)
 R - Radius of arc surface to be dressed
 L - Distance from tip of diamond to base plate

To dress convex arc surface: $H=L+R$
 To dress concave arc surface: $H=L-R$

SPECIFICATIONS

Center Height:	7.68"/195mm
Pin Diameter:.....	0.394"/10mm
Max. Swing Distance of Diamond Dresser:.....	±0.55"/14mm
Max. Wheel Diameter:.....	7.87"/200mm
Reading Accuracy of Turret Index:5'
Max. Translation of Feed:.....	0.98"/25mm
Feed Graduations of Handle Scale:.....	0.0003"/0.01mm

MADE IN TAIWAN

HHIP PRO-SERIES

3800-5210
\$1,100⁸⁷
(E)

REPLACEMENT DIAMOND ON PAGE 319

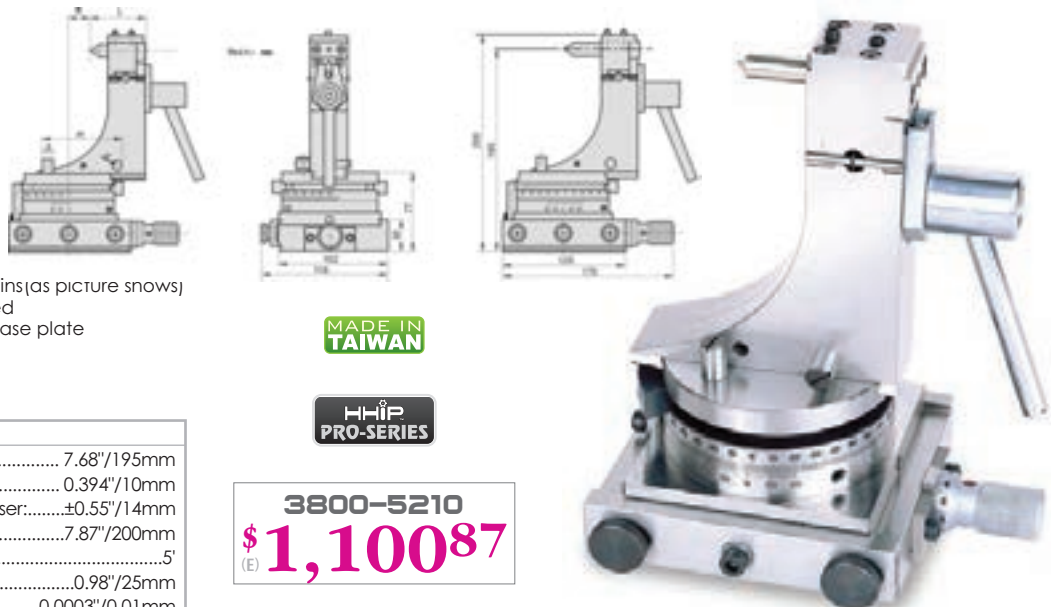

RADIUS & ANGLE DRESSERS

Pro-Series PRECISION SINE DRESSER

- Combination sine system and crossfeed for dressing grinding wheels at precise angles.

HHIP PRO-SERIES

3800-5240
\$27280
 (E)
 Weight: 3.5 lbs.

SPECIFICATIONS

Range of Angles:.....0~60°
 Distance of Rolls Center to Center:.....2"
 Accuracy:..... within 0.0002"
 Net Weight:.....3.5 lbs.

USE 3/8" DIAMOND DRESSER (not included)
 REPLACEMENT DIAMOND ON PAGE 319

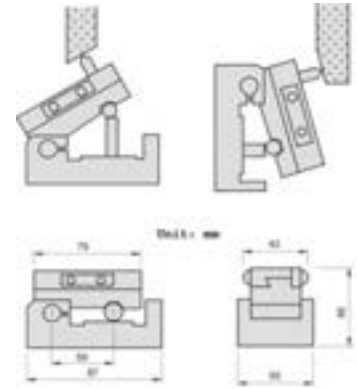

Pro-Series RADIUS AND ANGLE DRESSER

GRINDING WHEEL APPLICATIONS



3800-5227
\$1,18881
 (E)
 Weight: 26 lbs.

MADE IN TAIWAN

- Positive setting of the diamond to absolute center with the special gauge included with the dresser.
- Simple, fast, accurate radius setting; no height gauge or other set-up aids required. Radius is set on the grinder by measuring over the two pins or by inserting a gauge block, as shown, for direct reading. Inside or outside radius is determined simply by sliding the dowel pin to the right for concave and to the left for convex.
- 4x90° graduation in full 360° circle. 6 minute vernier reading.
- One push-pull type knob for radius and angle control and for safer and faster operations.
- ACCURACY, extremely close tolerances are held in the manufacturing of this tool, assured by hardening and precision grinding of all critical parts. Ways are chrome hardened.
- ECONOMY, set-up & dressing time reduced to a bare minimum due to simplicity.

SPECIFICATIONS

Max. Diameter of Wheel:.....10"
 Convex Range:..... 0.8R~40R
 Concave Range:.....0~40R
 Max. Wheel Extending Diameter:.....14.8"
 Overall Length:.....13"
 Overall Height:..... 6.3"
 Net Weight (lbs.):.....26

REPLACEMENT DIAMOND ON PAGE 319

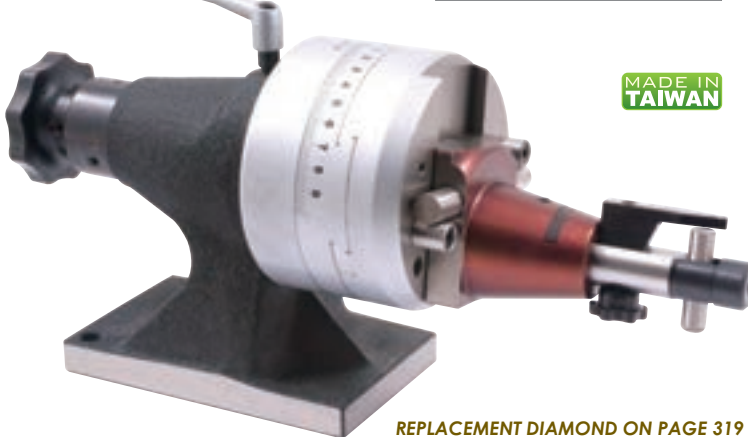

Pro-Series RADIUS AND ANGLE DRESSER

- Perfect for outside, inside diameter and surface grinding operations.
- Extreme accuracy and versatility is assured with dual purpose knob for radii and angular movements.
- Unique design features a fast, easy and accurate radius setting with included setting gauge.
- Stop feature available for concave and convex radii.
- Lapped moving parts and adjustable gibs take up future wear.

GRINDING WHEEL APPLICATIONS



MADE IN TAIWAN

3800-5225
\$1,07037
 (E)
 Weight: 27 lbs.

SPECIFICATIONS

Max. Diameter of Wheel:.....12"
 Convex Radii:..... 0~2.36"
 Concave Radii:.....0~5.90"
 Tangent Travel Either Side of Center:.....1.95"
 Center Line of Dresser:.....3.40"
 Resolution of Vernier Reading:..... 6'
 Overall Length:.....15.30"
 Overall Height:..... 5.90"
 Net Weight (lbs.):.....27

REPLACEMENT DIAMOND ON PAGE 319

MAX. VARIATION

Face Plate to Dresser Arm
 Squariness (per 2'):..... 0.0005"
 Face Plate to Base
 Squariness:..... 0.0006"
 Center Runout of Dovetail
 Groove to Wheel Center:..... 0.0006"

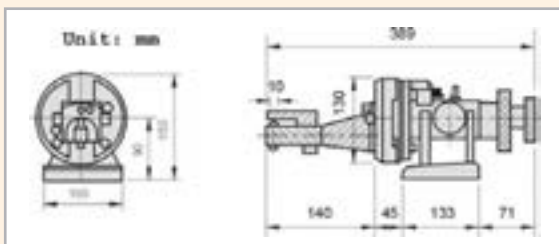

DIAMOND DRESSERS

SINGLE POINT DIAMOND DRESSERS - 3" Shank

- For straight dressing and dressing grinding wheels with simple profiles.
- 3" Long
- Single point



Carat (Approx.)	3/8x3" Item#	Price (F)	7/16x3" Item#	Price (F)	1/2x3" Item#	Price (F)
1/4	3903-0032	10.56	3903-0042	10.56	3903-0092	11.30
1/3	3903-0033	14.24	3903-0043	15.56	3903-0093	16.65
1/2	3903-0034	20.48	3903-0044	19.68	3903-0094	23.04
3/4	3903-0035	32.04	3903-0045	30.56	3903-0095	34.38
1	3903-0039	38.88	3903-0050	42.44	3903-0099	45.90

SINGLE POINT DIAMOND DRESSERS - 3" Shank



Carat (Approx.)	3/8x3" Item#	Price (F)	7/16x3" Item#	Price (F)
1/4	3900-0072	13.85	3900-0082	13.85
1/3	3900-0073	21.17	3900-0083	21.17
1/2	3900-0074	33.00	3900-0084	33.00
3/4	3900-0075	54.91	3900-0085	54.91
1	3900-0079	78.26	3900-0090	78.26

SINGLE POINT DIAMOND DRESSERS - 2" Shank



NEW

Carat (Approx.)	3/8x2" Item#	Price (F)	7/16x2" Item#	Price (F)
1/4	3903-0071	13.85	3903-0081	13.85
1/3	3903-0072	21.17	3903-0082	21.17
1/2	3903-0073	33.12	3903-0083	33.12
3/4	3903-0074	54.91	3903-0084	54.91
1	3903-0078	78.26	3903-0088	78.26

CONVEX RADIUS DIAMOND DRESSERS



Item#	Radius	Price (F)
3900-0077	.125-.250"	35.38
3900-0078	.250" & Up	35.38

**3/8 X 2" SHANK
OCTO STYLE**

GRINDING WHEEL DRESSER

- For dressing, truing, sharpening and removing glaze from solid abrasive wheels.
- Use on grinding wheels up to 1" Width
- Four Star-toothed Hardened Steel Cutters and Two Spacers Structure.
- Supplied with L-wrench.



Wheel Diameter: 1-1/4"
Face Width: 0.45"
Overall Length: 8-1/2"

3900-0062
\$1481
(F)

CONCAVE RADIUS DIAMOND DRESSERS



**3/8 X 2" SHANK
GN STYLE**

Item#	Radius	Price (F)
3900-0086	.010"	40.66
3900-0087	.015"	40.66
3900-0088	.020"	40.66

VM CONVEX RADIUS DIAMOND DRESSERS

- Concentric radius tools
- Special octahedron diamonds for fine work



3/8 X 2" SHANK



GRADE AAA 90°
3900-0097
\$4051
(F)

GRINDING DRIVING CARRIERS

- Suitable for grinding of shafts
- Precision Steel Castings.
- Easy attach and detach.

Limited Supply!

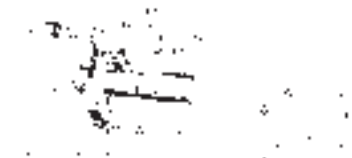

Item#	Capacity Diameter	Price (F)
2420-0014	.24~.55"	21.91
2420-0024	.51~.91"	24.33
2420-0033	.79~1.30"	29.22
2420-0042	1.22~1.65"	30.43



D1A1 STRAIGHT STYLE DIAMOND & CBN WHEELS

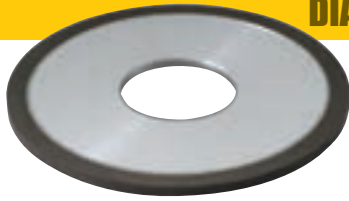

- 100% concentration.
- Arbor Hole: 1-1/4" (H)

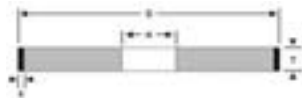

Wheel Diameter D	Wheel Thickness T	Diamond Depth X	Diamond (150 Grit) Item#	Price(F)	CBN (120 Grit) Item#	Price(F)
4"	1/16"	1/8"	2400-4062	63.93	2400-4063	92.40
4"	1/8"	1/8"	2400-4125	78.06	2400-4126*	80.00
4"	1/4"	1/8"	2400-4250	92.40	2400-4251	120.84
5"	1/8"	1/8"	2400-5125*	80.00	2400-5126*	100.00
5"	1/4"	1/8"	2400-5250*	90.00	2400-5251*	125.00
6"	1/16"	1/8"	2400-6062	92.40	2400-6063	120.84
6"	1/8"	1/8"	2400-6125	127.77	2400-6126	184.80
6"	1/4"	1/8"	2400-6250	128.35	2400-6251*	175.00
6"	3/8"	1/8"	2400-6375	191.79	2400-6376	269.76
6"	1/2"	1/8"	2400-6500	208.29	2400-6501	298.23
7"	1/4"	1/8"	2400-7250	184.80	2400-7251	248.73
7"	3/8"	1/8"	2400-7375	199.68	2400-7376*	200.00
7"	1/2"	1/8"	2400-7500	305.19	2400-7501*	300.00

*Limited Supply

D11V9 FLARING CUP DIAMOND & CBN WHEELS



- 100% concentration.
- Arbor Hole: 1-1/4" (H)
- For tool and cutter applications including sharpening of end mills, reamers, milling cutters and broaches.



STYLE D11V9

Wheel Diameter D	Wheel Thickness T	Diamond Depth X	Back Thick E	Back B	Diamond (150 Grit) Item#	Price(F)	CBN (120 Grit) Item#	Price(F)
3-3/4"	1-1/2"	1/8"	3/8"	70°	2404-4125	106.83	2404-4126	134.88
5"	1-3/4"	1/16"	1/2"	70°	2404-5062	119.40	2404-5063	177.78
5"	1-3/4"	1/8"	1/2"	70°	2404-5125	149.31	2404-5126	227.28

D11A2 FLARING CUP DIAMOND & CBN WHEELS



- 100% concentration.
- Arbor Hole: 1-1/4" (H)

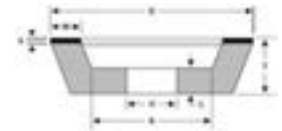

STYLE D11A2

Wheel Diameter D	Wheel Thickness T	Diamond Depth X	Rim Width W	Back Thick E	Diamond (150 Grit) Item#	Price(F)	CBN (120 Grit) Item#	Price(F)
3"	7/8"	1/8"	3/8"	3/8"	2405-3875	63.93	2405-3876	92.40
4"	1-1/4"	1/8"	1/2"	1/2"	2405-4250	92.40	2405-4251	134.88
5"	1-3/4"	1/8"	3/8"	1/2"	2405-5275	106.83	2405-5276	149.31

D1A1R DIAMOND & CBN CUT-OFF WHEELS



- Arbor hole: 1-1/4" (H)

STYLE D1A1R

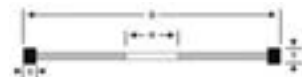

Wheel Diameter D	Thickness T	Diamond (150 Grit) Item#	Price (F)	CBN (120 Grit) Item#	Price (F)
4"	.035"	2401-4035	106.83	-----	-----
5"	.035"	-----	-----	2401-5036*	100.00
6"	.035"	2401-6035	163.35	2401-6036	184.80
6"	.045"	2401-6045	148.44	2401-6046*	125.00
8"	.045"	2401-8045	177.78	-----	-----

*Limited Supply

D12V9 DIAMOND DISH WHEELS

- 75% concentration
- Arbor hole: 1-1/4" (H)
- Diamond Grit: 150

STYLE D12V9



Wheel Diameter D	Wheel Thickness T	Diamond Depth X	Insert Length U	Back Thick E	Back B	Item#	Price (F)
4"	1/2"	1/16"	1/4"	1/4"	75°	2402-4062	63.87
4"	1/2"	1/8"	1/4"	1/4"	75°	2402-4125	78.06
6"	3/4"	1/8"	7/16"	7/16"	75°	2402-6125	132.15

6A2C DIAMOND & CBN PLAIN CUT WHEELS

- With countersunk bolt holes
- Mount on popular 6" carbide grinders
- Use for off-hand grinding on brazed tipped carbide single point turning tools.
- Back Thickness: 7/16"
- Arbor Hole : 1-1/4"(H)

STYLE 6A2C



75% CONCENTRATION

Wheel Diameter D	Wheel Thickness T	Diamond Width W	Diamond Depth X	Diamond (150 Grit) Item#	Price(F)	CBN (120 Grit) Item#	Price(F)
6"	3/4"	1/2"	1/16"	2403-6502	154.05	-----	-----
6"	3/4"	3/4"	1/16"	2403-6752	192.50	-----	-----
6"	3/4"	1"	1/16"	2403-6998	269.76	2403-6999	348.15

*Limited Supply

100% CONCENTRATION

Wheel Diameter D	Wheel Thickness T	Diamond Width W	Diamond Depth X	Diamond (150 Grit) Item#	Price(F)	CBN (120 Grit) Item#	Price(F)
6"	3/4"	3/4"	1/8"	2403-6500*	200.00	-----	-----
6"	3/4"	1"	1/16"	2403-6750	298.23	2403-6751*	300.00

D12A2 DISH DIAMOND & CBN WHEELS

- 100% concentration.
- Arbor Hole: 1-1/4" (H)



STYLE D12A2



Wheel Diameter D	Wheel Thickness T	Diamond Depth X	Rim Width W	Back Thick E	Back B	Diamond (150 Grit) Item#	Price(F)	CBN (120 Grit) Item#	Price(F)
6"	1"	1/8"	3/16"	1/2"	30°	2406-6187	106.83	2406-6188*	100.00
6"	1"	1/8"	1/4"	1/2"	30°	2406-6250*	110.00	2406-6251*	175.00
6"	1"	1/8"	3/8"	1/2"	30°	2406-6375*	198.81	-----	-----

*Limited Supply

GRINDING WHEEL ADAPTERS

F350 GRINDING WHEEL ADAPTER

- Hardened and ground
- For 1-1/4" I.D. Wheels
- Balance adjustable
- Wheel width capacity: 1/4 to 3/4"
- 1" diameter at large end of taper hole
- 1-1/4"-16 thread (left hand)
- Heat treated and precision ground
- Heat treated nuts
- Adapter O.D.: 3"

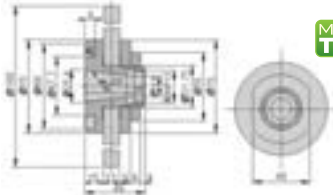

MADE IN TAIWAN



2420-0350
\$5650 (F)

F520 GRINDING WHEEL ADAPTER/FLANGE

- F520 is suitable for OKAMOTO 52DX cylinder of tool grinder.
- Hardened and ground
- For 1-1/4" I.D. Wheels

2420-0520
\$11454 (F)

MADE IN TAIWAN

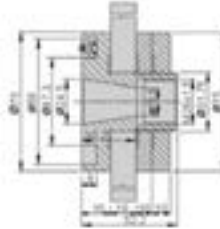

F450 GRINDING WHEEL ADAPTER

- F450 is used in cylinder of US standard grinding machines
- Hardened and ground.
- For 1-1/4" I.D. grinding wheels.
- Wheel width capacity: 1/4 to 3/4"
- 1" diameter at large end of taper hole

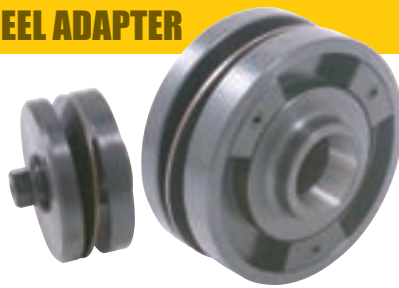
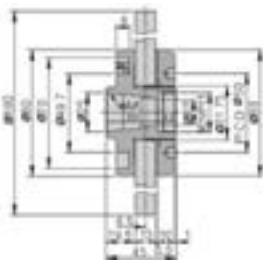

MADE IN TAIWAN

2420-0352
\$13200 (F)

W20 GRINDING WHEEL ADAPTER/FLANGE

- W20 is used for WAIDA optical profile grinder.
- Hardened and ground
- For 24mm I.D. Wheels

2420-0420
\$17179 (F)

MADE IN TAIWAN

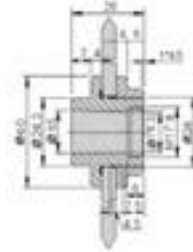

F300 GRINDING WHEEL ADAPTER/FLANGE

- F300 is applied to US standard 614, 618 surface grinding machines.
- Hardened and ground
- For 1-1/4" I.D. Wheels

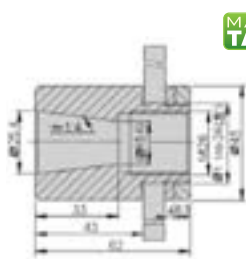

MADE IN TAIWAN



2420-0300
\$13860 (F)

W40 GRINDING WHEEL ADAPTER/FLANGE

- W40 is used for WAIDA optical profile grinder.
- Hardened and ground
- For 24mm I.D. Wheels

2420-0440
\$17179 (F)

MADE IN TAIWAN

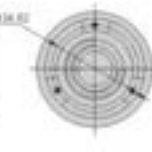
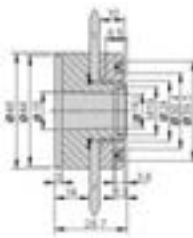

F320 GRINDING WHEEL ADAPTER/FLANGE

- F320 is used for US standard cylinder of tool grinder.
- Similar to sopko 1"
- Hardened and ground
- For 1-1/4" I.D. Wheels

2420-0320
\$7050 (F)

MADE IN TAIWAN

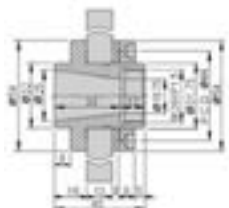

P60 GRINDING WHEEL ADAPTER/FLANGE

- P60 is used for Petewe optical profile grinder.
- Hardened and ground
- For 22mm I.D. Wheels

2420-0460
\$17179 (F)

MADE IN TAIWAN





FC110 WASINO GRINDING WHEEL ADAPTER/FLANGE

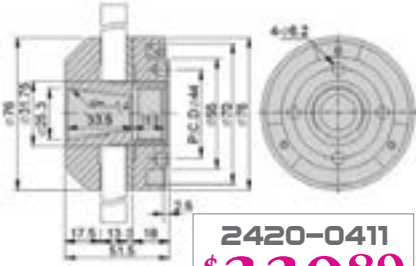

- FC110 is suitable for WASINO grinders.
- Hardened and ground

MADE IN TAIWAN

2420-0411
\$339⁸⁹

FEB10 TATUNG GRINDING WHEEL ADAPTER/FLANGE



- FEB10 is suitable for TATUNG EN350 grinders.
- Hardened and ground

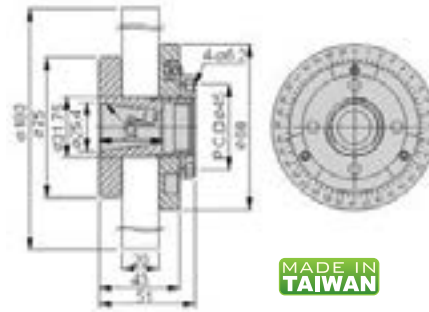

MADE IN TAIWAN

2420-0410
\$353⁰⁵

FC520 GRINDING WHEEL ADAPTER/FLANGE

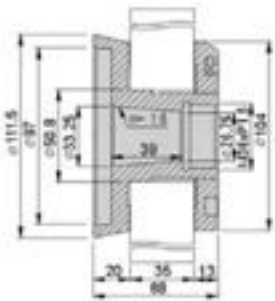

- FC520 is suitable for OKAMOTO ACC-52DX grinders.
- Hardened and ground
- Heat treated nuts

MADE IN TAIWAN

2420-0452
\$732⁶⁰



FEB18 TATUNG/OKAMOTO GRINDING WHEEL ADAPTER/FLANGE

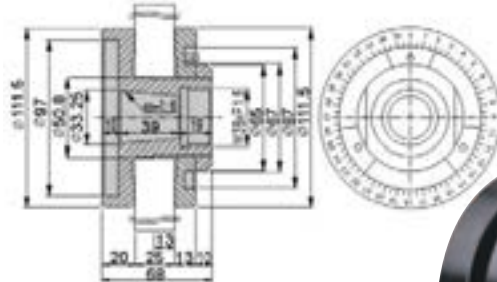

- FEB18 is suitable for TATUNG , OKAMOTO ACC-52DX grinders.
- Hardened and ground

MADE IN TAIWAN

2420-0418
\$544⁴⁹



FC630 GRINDING WHEEL ADAPTER/FLANGE

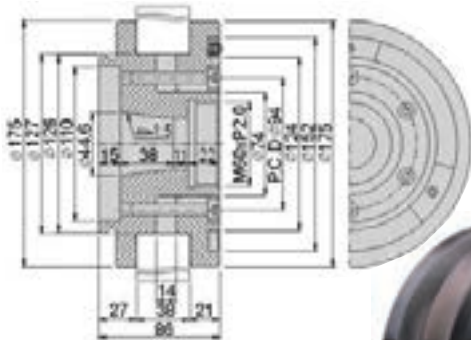

- F630 is suitable for OKAMOTO ACC-63DX, TATUNG PSG-64 grinders.
- Hardened and ground

2420-0463
\$927²⁹

MADE IN TAIWAN



FEB22 TATUNG/OKAMOTO GRINDING WHEEL ADAPTER/FLANGE

- FEB22 is suitable for OKAMOTO ACC-63DX, TATUNG PSG-64 grinders.
- Hardened and ground

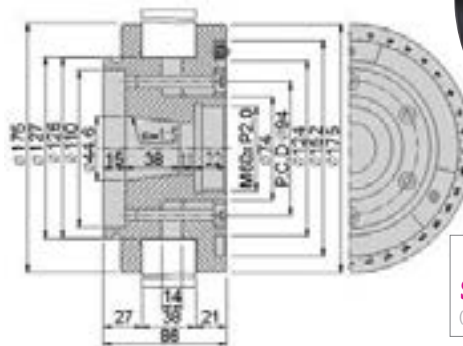

MADE IN TAIWAN

2420-0422
\$927²⁹



FEB20 KENT GRINDING WHEEL ADAPTER/FLANGE

- FEB20 is suitable for KENT 410 grinders.
- Hardened and ground
- Laser mark graduation reading on plates.

2420-0424
\$544⁴⁹

MADE IN TAIWAN

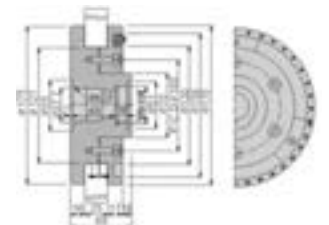

PERMANENT MAGNETIC CHUCKS

PERMANENT MAGNETIC CHUCKS -Standard Pole

- Can be used for processing various magnetic conduction work pieces.
- For surface grinder, tool grinder, EDM and other applications.
- Chucks are sealed and lubricated to be maintenance free.
- Magnetic force ON/OFF switch.
- Ceramic dense magnets for superior holding power.
- Removable handle.

Item#	Table Size	Table Length L (mm)	Table Width B (mm)	Table Height H (mm)	T (mm)	P	Weight (lbs)	Price (E)
3402-0838	8 x 18"	450	200	53	22	1+3	87	1,282.60
3402-0839	8 x 20"	500	200	53	22	1+3	92	1,484.82
3402-0840*	8 x 24"	600	200	53	22	1+3	110	1,426.14
3402-0844	10 x 16"	400	250	58	23	1+3	100	1,484.82
3402-0848	10 x 18"	450	250	58	23	1+3	113	1,754.46
3402-0850*	10 x 24"	500	250	58	23	1+3	125	1,527.90
3402-0852*	10 x 24"	600	250	58	23	1+3	150	1,935.16
3402-0858*	12 x 24"	500	300	58	23	1+3	150	1,884.30
3402-0860*	12 x 24"	600	300	58	23	1+3	169	2,834.10

*Limited Supply



STANDARD POLE

Pro-Series PERMANENT MAGNETIC CHUCKS -Standard Pole

- Can be used for processing various magnetic conduction work pieces.
- For surface grinder, tool grinder, EDM and other applications.
- Chucks are sealed and lubricated to be maintenance free.
- Magnetic force ON/OFF switch.
- Ceramic dense magnets for superior holding power.
- Removable handle.

SIDE MAGNETIC FORCE 18KG, PLATE CENTER 26KG

SUIT FOR WORK PIECE THICKNESS > 3MM LENGTH > 25MM

Item#	Table Size	A (mm)	B (mm)	C (mm)	D (mm)	Pole P	G (mm)	E (mm)	F (mm)	H (mm)	Weight (lbs)	Price (E)
3402-1801	4 x 7"	100	175	146	20	8(2+6)	8	187	15	50	16	497.68
3402-1802	5 x 10"	125	250	206	20	8(2+6)	8	262	15	50	33	737.70
3402-1803	6 x 12"	150	300	256	20	8(2+6)	8	318	15	50	41	829.50
3402-1808	6 x 18"	150	450	406	20	8(2+6)	8	468	15	50	61	1,149.30



STANDARD POLE

PERMANENT MAGNETIC CHUCKS -Fine Pole

- Can be used for processing various magnetic conduction work pieces.
- For surface grinder, tool grinder, EDM and other applications.
- Chucks are sealed and lubricated to be maintenance free.
- Ceramic dense magnets for superior holding power.
- Removable handle.

Item#	Table Size W x L	Pole Height	Table Height	Pole Spacing	Weight (lbs)	Price (E)
3402-0801	4 x 7"	0.70"	1.60"	1/16 x 1/32"	19	337.40
3402-0802	5 x 10"	0.70"	1.60"	1/16 x 1/32"	35	459.11
3402-0803	6 x 12"	0.70"	1.60"	1/16 x 1/32"	47	627.81
3402-0804	6 x 18"	0.70"	1.60"	1/16 x 1/32"	65	944.80
3402-0806*	8 x 18"	0.87"	1.97"	1/16 x 1/32"	130	1,336.16
3402-0807*	8 x 20"	0.87"	1.97"	1/16 x 1/32"	140	1,538.75
3402-0805*	8 x 22"	0.87"	1.97"	1/16 x 1/32"	150	1,741.71

*Limited Supply



FINE POLE

MAGNETIC SINE PLATE -Fine Pole



FINE POLE

- Ceramic dense permanent magnets plate provide extreme power up to 100 lbs.
- Fine pole spacing works for both thick and thin parts.
- Rigid angles lock strap capacity 0~60° (Accuracy 5" /per 15°).
- Hardened side and back rolls included.
- Made of high grade steel hardened to 55~62 RC and ground.
- Removable On/Off handle included.
- Gross Weight: 35 lbs.

3402-0810
\$1,203.73
 (E)

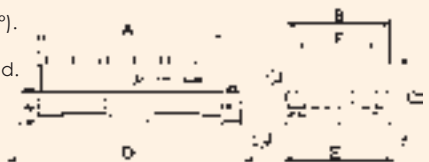

Size AxBxC	Rolls Center F	Pole Spacing	Square & Parallel	D	E
6 x 6 x 4"	100mm	1/16 x 1/32"	.0003"	8"	6"

ROUND MAGNETIC CHUCKS-STANDARD POLE

- Chucks are sealed and lubricated to be maintenance free.
- Ceramic permanent magnets for superior holding power.
- Bottom surface has tapped holes with counterbores for convenient mounting.
- Handle is removable for turning on/off magnet.



BOTTOM VIEW



STANDARD POLE

Item#	Size D	Height H	Height (MM)			Pole Spacing P	Wt. (lbs.)	Price (F)
			K	C	Z-M			
3402-0821*	150mm(6")	48	3	100	M6x1.0	1+3	15	488.88
3402-0823	200mm(8")	52	4	120	M8x1.25	1+3	28	787.38
3402-0827*	300mm(12")	58	4	220	M8x1.25	1+3	70	1,846.29

*Limited Supply

ROUND MAGNETIC CHUCKS-FINE POLE

- Chucks are sealed and lubricated to be maintenance free.
- Ceramic permanent magnets for superior holding power.
- Bottom surface with tapped holes with counterbores for convenient mounting.
- Handle is removable for turning on/off magnet.

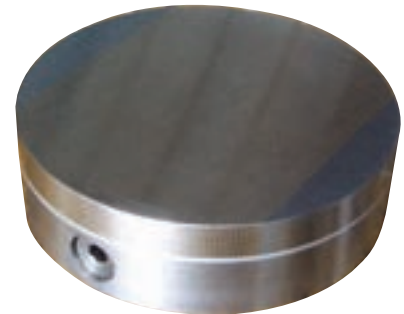

FINE POLE

Item#	Size	Height	Pole Spacing	Wt. (lbs.)	Price (F)
3402-0822	6"	2-15/16	1/16 x 1/32"	18	481.25
3402-0824	8"	3-1/8	1/16 x 1/32"	29	786.50
3402-0828	12"	3-5/16	1/16 x 1/32"	65	1,707.75

Pro-Series PERMANENT MAGNETIC SINE BAR

SPECIFICATIONS

Base Magnetic Power:.....8 lbs.
 Parallelism:.....within 0.0001"
 Squareness:.....within 0.0002"
 Distance between Roll Centers:.....2"
 Rolls Accuracy:.....+ 0.00008"
 Overall Length:.....3"

- Designed for any machine on angular testing.
- Magnetic base with permanent power pull
- Hardened and precision ground HRC 56~68.

HHIP
PRO-SERIES

3800-5410
\$2860¹

MADE IN
TAIWAN



MAGNETIC V-BLOCKS & PARALLELS

- Universal-holds in any direction on the magnetic chuck.
- Aluminum cast.
- Ground all over.
- Blocks transmit magnetism, they are not magnetic.

USE ON MAGNETIC CHUCK

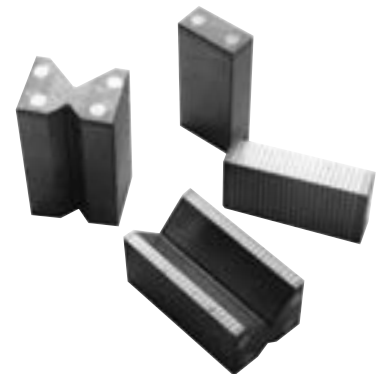

V-BLOCK &
PARALLELS KIT
3402-0013
\$120⁹⁷

Item 3402-0006 & 3402-0009

V-BLOCKS:

- 90° Vee Capacity:
Small Vee-1/2", Large Vee-2"

Item#	Description	Length	Width	Height	Price (E)
3402-0007	SINGLE 90° V-BLOCK	4-3/8"	2-3/8"	1-7/8"	77.17
3402-0006	MATCHED PAIR 90° V-BLOCK	2"	2-3/8"	1-7/8"	75.95
3402-0009	MATCHED PAIR PARALLELS	4"	2"	1"	59.70

6x6 ULTRA PRECISION SINE PLATES



- Made of high grade tool steel hardened and precision ground HRC 55~58.
- Two hardened side rails and one locking strap included.

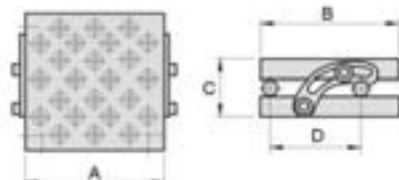

Value
3900-5526
\$24750

MADE IN CHINA

HHIP
PRO-SERIES
3800-5526
\$5565¹

MADE IN TAIWAN

SPECIFICATIONS

Capacity:.....0~60°
 Squareness:.....within 0.0002"
 Parallelism:.....within 0.0002"
 Center Distance of Rolls Accuracy:.....within 0.0002"
 Minute Angle Step on Gage Block Roll:.....0.200"
 Tapped holes:.....1/4"-20 UNC
 Size (B x A).....6" x 6"
 Height (C).....2.36
 Center Distance of Rolls (D).....5"
 No. of Tapped Hole.....24
 Wt. (lbs.).....18

TOOLMAKER'S VISES

1" TOOLMAKER'S VISE

- Hardened and precision ground.
- The "no-rise" jaw construction exerts a continual downward pressure to the jaw, eliminating tilting & lifting
- Jaw can be opened and closed without unbolting from work surface.
- **With step jaws.**



SQUARE & PARALLEL .0002"

Item#	Jaw Width	Jaw Depth	Jaw Opening	OAL	Price (F)
3900-0124	1"	0.5"	1"	2.6"	44.95

38mm TOOLMAKER'S VISE

- Hardened and precision ground.
- The "no-rise" jaw construction exerts a continual downward pressure to the jaw, eliminating tilting & lifting
- Jaw can be opened and closed without unbolting from work surface.
- **No step jaws.**
- **1.5" jaw width.**

SQUARE & PARALLEL .0002"

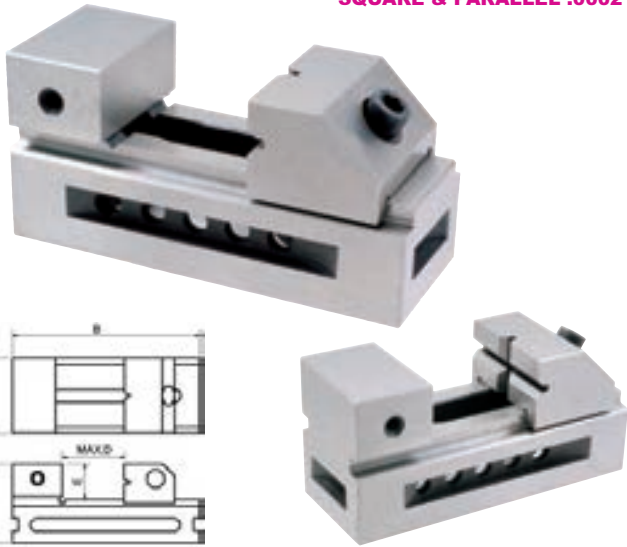

Item#	Jaw Width A	Jaw Depth E	Jaw Opening D	Vise Ht. C	OAL B	Price (F)
3900-0125	38mm	20mm	40mm	48mm	100mm	77.62

TOOLMAKER'S VISES-Without Slot

- Hardened and precision ground.
- No clamping slot.
- Ground "V" way in sliding jaw.

SQUARE & PARALLEL .0002"

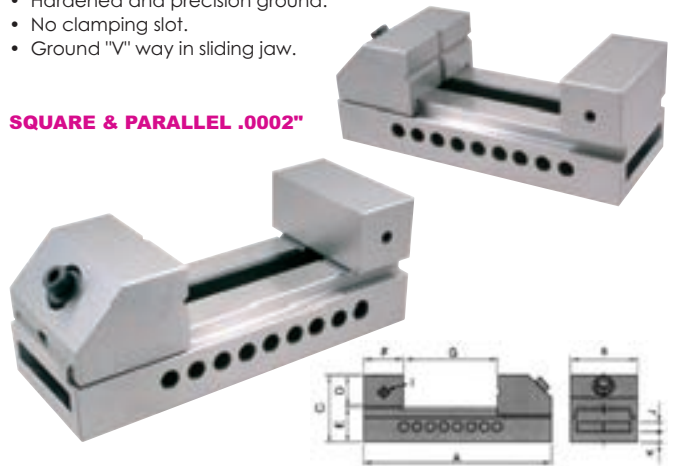

Item#	Jaw Width B	Jaw Depth D	Jaw Opening G	A	C	Weight Lbs.	Price (F)
3900-0122	2"	1.00"	2.4"	5.3"	2"	4.0	107.80
3900-0123	3"	1.38"	3.8"	7.3"	3"	9.5	112.53

PRECISION SCREWLESS VISES

- With V-Groove
- Oil hardened.
- Precision ground.
- Rapid positioning notches.
- .00025" square and parallel.

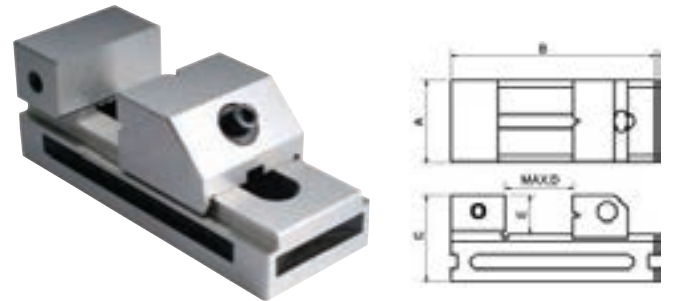

Item#	Jaw Width A	Jaw Depth E	Jaw Opening D	Vise Ht. C	OAL B	Price (F)
3900-0020	1"	3/8"	1"	1.2"	2-5/8"	48.33
3900-0022*	2"	1-1/4"	2.25"	2.0"	6"	71.98
3900-0024*	3"	1-5/8"	4"	3.2"	7-5/8"	135.65

*Limited Supply

PRECISION TOOLMAKER'S VISES-Screw Type

- All surfaces are hardened (52~58 HRC) and precision ground square and parallel to accuracy of +/- .0002".
- Clamping slots are provided and jaws are easily replaced.
- Ground "V" way.

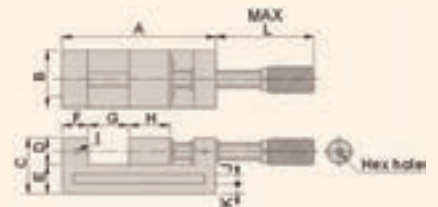

Unit: mm

Item#	Jaw Width	A	B	C	D	E	F	G	H	I	J	L	Weight	Price (F)
3900-0067	2"	156	48	52	25	27	25	0-63	34	M6	8	125	5.1 lbs	110.83
3900-0251	3"	190	73	73	35	38	35	0-76	45	M6	10	151	12.1 lbs	183.46
3900-0068	4"	255	98	82	40	42	40	0-120	50	M8	12	196	24.2 lbs	323.95

ULTRA PRECISION TOOLMAKER'S VISES

- Hardened and precision ground, HRC55-60°.
- The "no-rise" jaw construction exerts a continual downward pressure to the jaw, eliminating tilting & lifting.

- Jaw can be opened and closed without unbolting from work surface.
- Tolerance within .00012"(Parallelism), .0002" (Squareness).

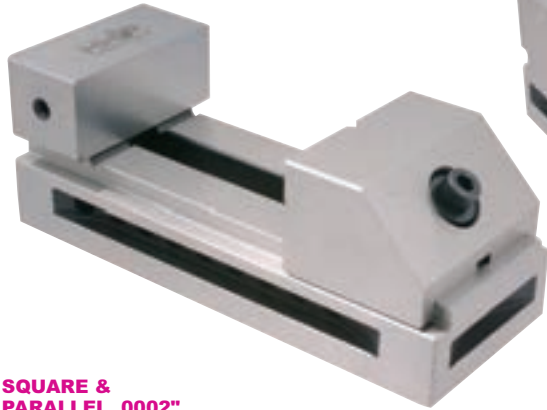

SQUARE & PARALLEL .0002"



HiP PRO-SERIES

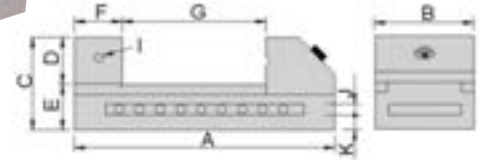

Item#	Jaw Width B	(mm)										Price (F)
		A	C	D	E	F	G	I	J	K		
3900-2012	50	150	53	25	28	30	0-80	M6	8	8	108.09	
3900-2013	73	190	70	35	35	35	0-100	M6	10	12	141.37	
3900-2003	88	235	80	40	40	40	0-130	M8	12	14	220.97	
3900-2014	100	245	90	45	45	45	0-130	M8	12	16	294.71	
3900-2015	125	285	100	50	50	45	0-160	M8	14	18	448.05	

PRECISION SINE VISES

- Hardened and precision ground, provides a tolerance of .0004" for both parallelism and squareness.
- Sine range: 6-60°.
- Jaw can be opened or closed without unbolting from work surface.

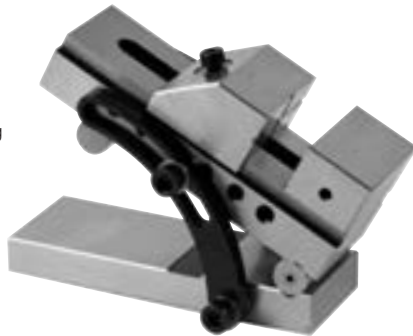

Item#	Jaw Width	Jaw Depth	Jaw Opening	Center to Center	Base Size	Price (F)
3900-2603	2"	1"	2-5/8"	4.00"	5-3/8"x2"	148.50
3900-2605	3"	1-1/4"	4"	4.00"	7-5/8"x3"	226.91

MINI PRECISION TILT/SWIVEL VISE

- Hardened and precision ground tool steel.
- Horizontal swivel movement 360°.
- Vertical swivel movement 90° graduation in degrees for quick setting.
- Base has slots for clamping on the mill table.



Limited Supply!

3900-2625
\$299.00
(E)

Jaw Width	Jaw Height	Jaw Opening	OAL Height	Footprint
2-1/4"	25/32"	17/32"	3.7"	4.65x2.60"

Pro-Series UNIVERSAL MOVEMENT VISE

- This fixture is composed of two parts: namely a precision vise and a swivel angle plate base.
- Vise is capable of revolving 360° horizontally with 3° graduation engraved and ±45° vertical with 3° graduation engraved.
- L-wrench included for locking vise horizontal at any position.
- Vertical angle can be adjusted with fine adjustable knob.
- Hardened and precision ground. Provides a tolerance of 0.0004" Parallelism and Squareness.
- Unique universal movement for precision grinding, machining, boring and various applications.

HiP PRO-SERIES

MADE IN TAIWAN

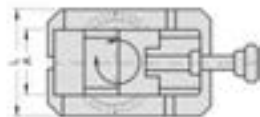
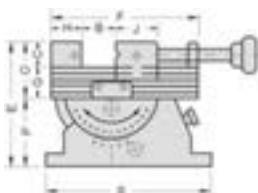

2-3/4" Jaw Width
3900-2621
\$1,384.47
(E)

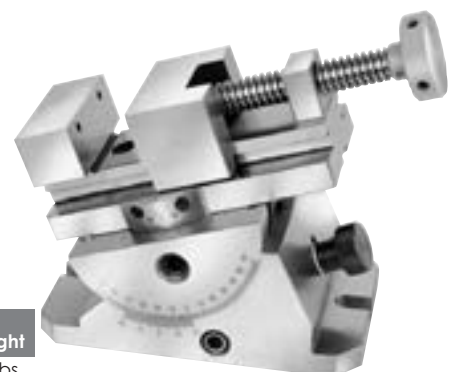

Jaw Width	Jaw Depth	Jaw Opening	(Inch)											Weight
			A	B	C	E	F	G	H	J	L	P	S	
2-3/4	1.18	3.15	3.75	3.15	1.18	5.39	6.3	1.3	1.3	1.8	4.33	2.95	7.09	31 lbs

MACHINE TOOL ACCESSORIES

Pro-Series STAINLESS STEEL VISES

STAINLESS STEEL VISE - 21MM Jaw Width



- A delicate vise suitable for clamping precision workpieces.
- Made of stainless steel SUS440 classified as corrosion & heat resistant for EDM, grinding and other applications which is sensitive to rust.
- Hardened and precision ground.
- Hardness: HRC 48~55°

SQUARE & PARALLEL .00012"

21MM JAW
3901-2721
\$320⁰²
(F)

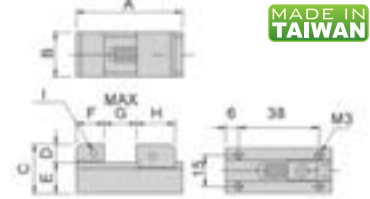

MADE IN TAIWAN

Jaw Width B	Jaw Depth D	Jaw Opening G	Vise Height C	Vise Length A	E	F	H	Threaded Hole I	Wt. (Lbs)
21mm	8.5mm	15mm	23.5mm	50mm	15mm	13mm	18mm	M3	0.4

STAINLESS STEEL VISES - 25MM Jaw Width

- A compact precision vise suitable for small precision workpieces, apply by wrench.
- Made of stainless steel SUS440 classified as corrosion & heat resistant for EDM, grinding and other applications which is sensitive to rust.

25MM JAW
3901-2725
\$138⁶⁵
(F)

25MM With Step Jaw
3901-2728
\$171⁶⁰
(F)

- Hardened and precision ground.
- Hardness: HRC 48~55°

MADE IN TAIWAN



3901-2725 Shown

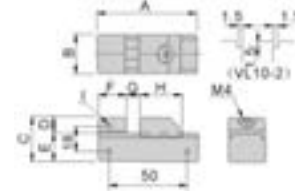
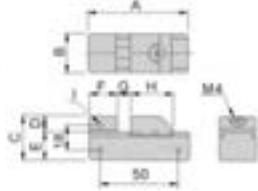

3901-2728 Shown

SQUARE & PARALLEL .00012"

Unit: mm

Item #	Step Jaws	Jaw Width B	Jaw Depth D	Jaw Opening G	Vise Height C	Vise Length A	E	F	H	Threaded Hole I	Wt. (Lbs)
3901-2725	No	25	12	20	32	65	20	20	25	M4	0.6
3901-2728	Yes	25	12	20	32	65	20	20	25	M4	0.6

STAINLESS STEEL TOOLMAKERS VISE - 73MM Jaw Width

- Made of stainless steel SUS440 classified as corrosion & heat resistant for EDM, grinding and other applications which is sensitive to rust.
- Hardened and precision ground.
- Hardness: HRC 48~55°

SQUARENESS < 0.0002"
PARALLELISM < 0.00012"

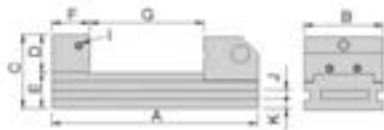

73MM JAW
3901-2772
\$1,012⁰⁰
(E)



MADE IN TAIWAN

Jaw Width B	Jaw Depth D	Jaw Opening G	Vise Height C	Vise Length A	E	P	Wt. (Lbs)
73mm	35mm	100mm	70mm	190mm	35mm	50mm	9.5

STAINLESS STEEL TOOLMAKER'S & EDM VISE - 50mm or 72mm Jaw Width

- Suitable for high precision grinding, milling and EDM.
- Made of stainless steel SUS440 classified as corrosion & heat resistant for EDM, grinding and other applications which is sensitive to rust.
- Hardened and precision ground.
- Hardness: HRC 48~55°

SQUARE & PARALLEL .00012"

50MM JAW
3901-2732
\$627⁰⁰
(F)

72MM JAW
3901-2734
\$907⁴⁹
(F)

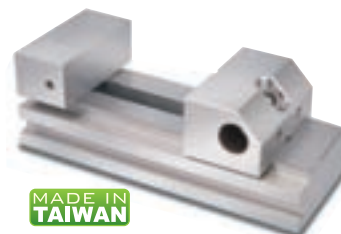

MADE IN TAIWAN

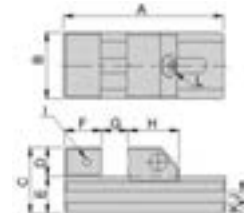

Unit: mm

Item #	Jaw Width B	Jaw Depth D	Jaw Opening G	Vise Height C	Vise Length A	E	F	H	Threaded Hole I	Slot J	K	Wt. (Lbs)
3901-2732	50	25	75	53	140	28	25	40	M6	6 W x 5 D	8.5	3.3
3901-2734	72	30	100	62	180	32	35	45	M6	8 W x 7 D	9.0	6.6

STAINLESS STEEL VISE - Screwless Type

- Hardened and precision ground.
- Made of stainless steel specially for EDM, grinding and other application which is sensitive to rust.

SQUARE & PARALLEL .0002"

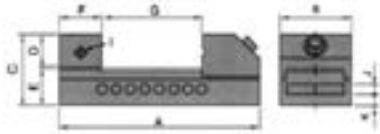

2-3/4" JAW
3900-2001
\$53978
 (E)



Jaw Width B	Jaw Depth D	Jaw Opening G	Vise Height C	Vise Length A	E	F	Weight (Lbs)
2.87"	1.38"	3.94"	2.68"	7.48"	1.3"	1.38"	9.8

STAINLESS STEEL VISE WITH HANDLE - 25MM Jaw Width

- Screw rod design allows you to easily tighten the jaws on tight workpieces.
- Made of stainless steel SUS440 classified as corrosion & heat resistant for EDM, grinding and other applications which is sensitive to rust.
- Hardened and precision ground.
- Hardness: HRC 48~55°

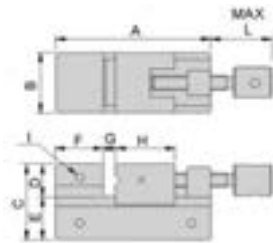

MADE IN TAIWAN

25MM JAW
3901-2741
\$25603
 (F)

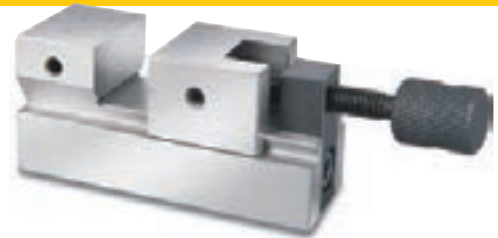

SQUARE & PARALLEL .00012"

Jaw Width B	Jaw Depth D	Jaw Opening G	Vise Height C	Vise Length A	Max. L	E	F	H	Threaded Hole I	Wt. (Lbs)
25mm	14mm	25mm	32mm	70mm	43mm	18mm	20mm	25mm	M4	1.1

STAINLESS STEEL VISE WITH HANDLE - 35MM Jaw Width

- New structure design with higher repeatability and stability.
- Compact screw rod design for easy tightening.
- Made of stainless steel SUS440 classified as corrosion & heat resistant for EDM, grinding and other applications which is sensitive to rust.

- Hardened and precision ground.
- Hardness: HRC 48~55°

SQUARE & PARALLEL .00012"

35MM JAW
3901-2755
\$50160
 (F)

MADE IN TAIWAN

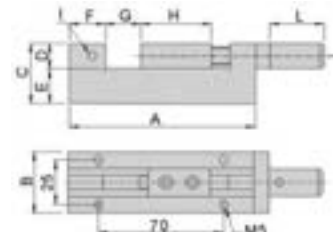

Jaw Width B	Jaw Depth D	Jaw Opening G	Vise Height C	Vise Length A	E	F	H	Threaded Hole I	Wt. (Lbs)
35mm	15mm	30mm	35mm	105mm	20mm	20mm	40mm	M5	2.5

STAINLESS STEEL SINE VISE - For EDM/Toolmakers

- Screw rod design allows you to easily tighten the jaws on tight workpieces.
- Precision sine vise suitable for precision and small workpieces.
- Screw rod design for easy tightening.
- Made of stainless steel SUS440 classified as corrosion & heat resistant for EDM, grinding and other applications which is sensitive to rust.
- Hardened and precision ground.
- Hardness: HRC 48~55°

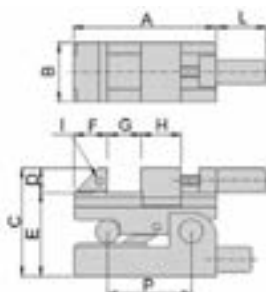

MADE IN TAIWAN

35MM JAW
3901-2760
\$81509
 (F)

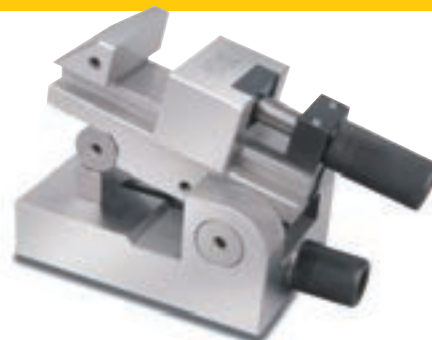

Jaw Width B	Jaw Depth D	Jaw Opening G	Vise Height C	Vise Length A	L	E	F	H	Threaded Hole I	P	Wt. (Lbs)
35mm	15mm	30mm	65mm	85mm	37mm	50mm	20mm	24mm	M4	50mm	2.2

Pro-Series STAINLESS STEEL VISES

STAINLESS STEEL VISE WITH HANDLE - 36MM Jaw Width

- Screw rod design for easy tightening.
- Made of stainless steel SUS440 classified as corrosion & heat resistant for EDM, grinding and other applications which is sensitive to rust.
- Hardened and precision ground.
- Hardness: HRC 48~55°

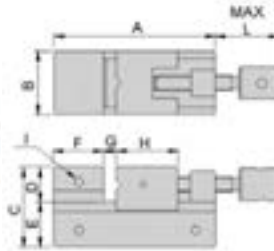

MADE IN TAIWAN

36MM JAW
3901-2743
\$376²⁰_(F)

SQUARE & PARALLEL .00012"

Jaw Width B	Jaw Depth D	Jaw Opening G	Vise Height C	Vise Length A	Max. L	E	F	H	Threaded Hole I	Wt. (Lbs)
36mm	16.5mm	50mm	35mm	100mm	76.5mm	18.5mm	20mm	30mm	M5	2.2

STAINLESS STEEL COMPACT VISE WITH HANDLE - 40MM Jaw Width

- Compact structure vise with a special design to prevent any floating of workpiece when clamped.
- Compact screw rod design for easy tightening.
- Made of stainless steel SUS440 classified as corrosion & heat resistant for EDM, grinding and other applications which is sensitive to rust.
- Hardened and precision ground.
- Hardness: HRC 48~55°

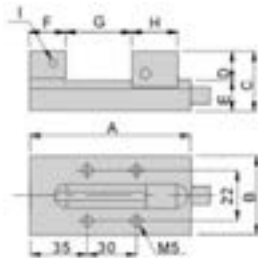

MADE IN TAIWAN

40MM JAW
3901-2750
\$501⁶⁰_(F)

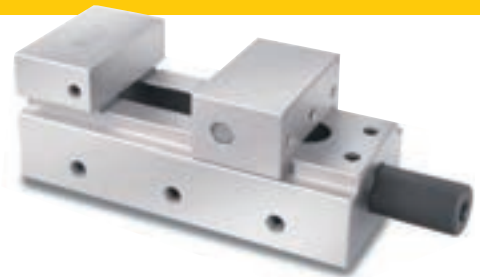

SQUARE & PARALLEL .00012"

Jaw Width B	Jaw Depth D	Jaw Opening G	Vise Height C	Vise Length A	E	F	H	Threaded Hole I	Wt. (Lbs)
40mm	15mm	40mm	40mm	100mm	25mm	25mm	25mm	M5	2.2

STAINLESS STEEL TOOLMAKERS VISE - 1-3/4" Jaw Width

- Hardened and ground.
- Made of stainless steel specially for EDM, grinding and other application which is sensitive to rust.
- Hardness: 48~55°

SQUARE & PARALLEL: .00012"

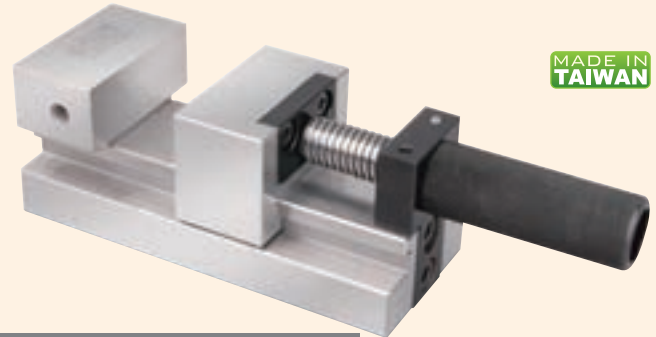
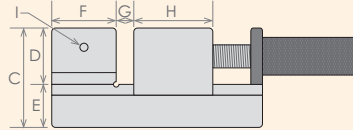
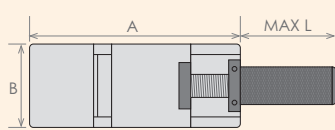

MADE IN TAIWAN

Item#	Jaw Width B	Jaw Depth D	Jaw Opening G	Vise Height C	Vise Length A	E	F	H	I	Weight (Lbs)	Price (F)
3900-2004	1-3/4"	0.79"	0~1.97"	1.77	4.33"	0.98"	0.98"	0.94"	M5	3.8	554.60

SCREW ROD DESIGN LOCKS TIGHT TO HOLD SMALL WORKPIECE.

STAINLESS STEEL VISES - Screw Type

- Hardened and precision ground.
- Made of stainless steel specially for EDM, grinding and other application which is sensitive to rust.

MADE IN TAIWAN

SQUARE & PARALLEL .0002"

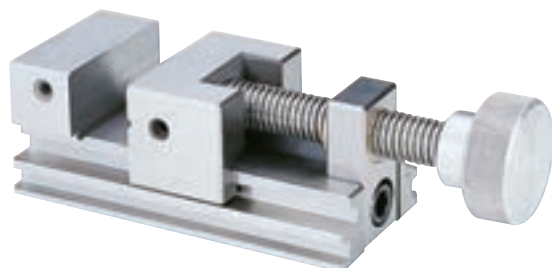

2-3/4" Jaw Width
3900-2005
\$529⁵⁹_(F)



WORK LIGHTS & MAGNIFIERS

FLEXIBLE SHAFT WATERPROOF IP54 LED WORK LIGHT

- CREE XPG high performance LED light provides an excellent solution for heat sensitive environment.
- Small head (0.8" Diameter) with zoom ring for adjusting brightness
- IP54 dustproof and waterproof
- Strong magnetic base with 1.5" diameter grip can be handled as a flash light or stick on a metal surface.
- Battery Run Time: 8 hours high(200 LUMENS), 20 hours low(80 LUMENS)
- On/Off button
- 18" flexible shaft.
- Use 3xAA battery.

IP 54

OVERALL LENGTH: 24"
BRIGHTNESS: 200 LUMENS

8401-0439
\$2874
(F)



Unit: mm

LAMP ON MAGNETIC BASE

- Powerful magnetic base with On/Off switch.
- Guaranteed power pull 130 lbs.
- Flexible arm for any position adjustment.
- 60 VA power rating.
- Power supply: 115V/ 60Hz/ 1 Phase.
- Uses regular screw-on bulb (not included).
- Base Dimension: 2-5/16" L x 2" W x 2" H

8401-0049
\$4045
(E)



WORK LIGHT ON MAGNETIC BASE WITH FLEXIBLE ARM

8401-0050
\$6159
(E)

- Powerful magnetic base with On/Off switch, holding power 180 lbs.
- Magnetic base dimension: 2-5/16 L x 2 W x 2" H
- Loc-line style flexible arm
- Use regular screw-on bulb(not included)
- Power Supply: 110V/1 Phase

MADE IN TAIWAN



8x LED LIGHT DESK TOP MAGNIFIER

- 8x powerful magnifier in diopters
- Flexible arm any desired position adjustable
- Diameter of Visible Area: 5"
- Adjustable LED light with 300 LUX brightness, 2.5Watt.
- Power Supply: 110V/1 phase
- Furnished with 60" cord.

8070-0001
\$7150
(F)

BRIGHTNESS: 300 LUMENS

Replacement Bulb (8070-0004)..... \$1.70 (F)



WATERPROOF LED WORKING LIGHTS-Small Head

- LED lights (1.1 Watt) provide an excellent solution for heat sensitive environment.
- Small head (1.2" Diameter) with high brightness
- 50,000 hours LED lifetime
- Arm Length: 21.50".
- Power Supply: 110V AC/ 1 phase.

BRIGHTNESS: 110 LUMENS



Bolt On
8401-0458
\$7819
(F)

Bolt-On Mounting Plate:
2-3/8 x 2-3/8"

With Mag. Base
8401-0459
\$8537
(F)

Magnetic Base: 2-3/8 x 2-3/8"
with 110 lbs power pull.

WATERPROOF LED WORKING LIGHTS

- LED lights provide an excellent solution for heat intensive environment.
- High Brightness with 330 Lumens
- Magnetic Base: 2 x2 " with 110 lbs power pull.
- 50,000 hours LED lifetime
- Arm Length: 20".
- Power Supply: 110V AC/ 1 phase.
- Bolt-On Mounting Plate: 2 x 2"

BRIGHTNESS: 330 LUMENS



Bolt on WORK LIGHT
8401-0448
\$6674
(F)

Work Light on Mag. Base
8401-0449
\$10215
(F)

22" LED WORKING LIGHT-Bolt On

- LED lights provide an excellent solution for heat intensive environment.
- 18" goose neck.
- Lasts 50 times longer than regular flashlights.
- 30 LED bulbs provides brighter and stronger natural light.
- Power Supply: 110V AC/ single phase.



8401-0443
\$5883
(F)

BRIGHTNESS: 250 LUMENS

25" LED WORKING LIGHT -On Magnetic Base

BRIGHTNESS: 250 LUMENS

- 18.5" gooseneck.
- Magnetic Base: 2-1/2x2" with On/Off switch, 150 lbs power pull.
- LED lights provide an excellent solution for heat intensive environment.
- Lasts 50 times longer than regular flashlights.
- 30 LED bulbs provides brighter and stronger natural light.
- Power Supply: 110V AC/ single phase.



8401-0445
\$8653
(F)

7W WATERPROOF LED WORK LIGHT

- LED lights (7 Watt) provide an excellent solution for heat sensitive environment.
- The head of light installed filterable ultraviolet ray high temperature resisting glass and heat insulation structure
- Light head diameter: 4-3/8".
- Universal movement.
- 50,000 hours LED lifetime.
- Flux: 700Lm.
- Color temperature: 6500 K
- Power Supply: 110V AC/ 1 phase.
- Switch On/Off.

Bolt-On Mounting Plate:
2-3/8 x 2-3/8"

With Swivel Arm
Total 18" Length (8+9")
8401-0466
\$9339
(F)

BRIGHTNESS: 700 LUMENS



INDUSTRIAL GRADE LED LAMP MAGNIFIER

- Light source LED, 390 Lums brightness.
- Lens Size: 7.5x6.0".
- Lens frame: 12x9".
- Lens material: glass.
- 3 diopter lens provides 1.75x magnification.
- Swing arm with 32" reach.
- Max. 2-1/2" adjustable bench clamp.
- Power On/Off switch.
- Power Supply: 115V.



BRIGHTNESS: 390 LUMENS

8401-0045
\$16513
(E)

5W WATERPROOF LED WORK LIGHTS

- LED lights (5 Watt) provide an excellent solution for heat sensitive environment.
- Lights head diameter: 2-3/8".
- Universal movement.
- 50,000 hours LED lifetime.
- Flux: 350Lm.
- Color temperature: 6500 K
- Power Supply: 110V AC/ 1 phase.
- Plug-in to turn on.



Bolt-On Mounting Plate:
2-3/8 x 2-3/8"

Without Arm
Overall Height 8"
8401-0462
\$9339
(F)

BRIGHTNESS:
350 LUMENS

With Swivel Arm
Total 18" Length (8+9")
8401-0463
\$10179
(F)

HALOGEN WORK LIGHT - WATERPROOF

- Totally enclosed lighting head provides well prevention for dust, coolant and lubricants.
- Efficient quartz halogen bulb (50W), great light output, soft illumination.
- Coil transformer built in base for directly connect to AC 110 V power .
- Furnished with 6 ft cord with plug.
- Full reach: 36"

BRIGHTNESS:
370~600 LUMENS

Work Light
8401-0452
\$19622
(F)

CE
MADE IN
TAIWAN

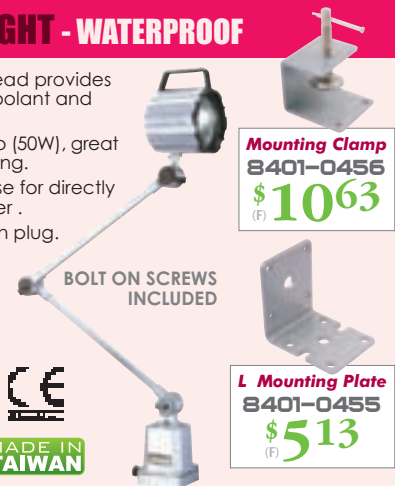

Mounting Clamp
8401-0456
\$1063
(F)

L Mounting Plate
8401-0455
\$513
(F)

WORK LIGHTS

CONCENTRATE LED WORK LIGHTS - Bolt On

- Dust proof.
- Suitable for small CNC, engraving, sewing machine and heat sensitive environment.
- Flexible movement with folding arms.
- Built-in transformer
- Power consumption: 5.3W
- Input 110V AC, output 12V DC
- Sturdy rod-arm with special joint.

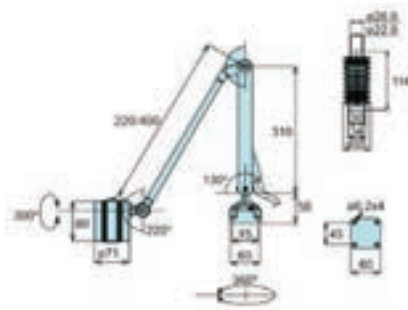

BRIGHTNESS: 330 LUMENS



MADE IN TAIWAN

Item #	Arm Length LxI	Use Bulb	Weight Lbs.	Price (F)
8401-0481	220x310mm	6W	4.0	190.65
8401-0483	400x310mm	6W	4.5	190.65



L Mounting Plate
8401-0485
\$694 (F)



Mounting Clamp
8401-0486
\$2006 (F)



Spare Bulb
8401-0488
\$7204 (F)

IP65 WATERPROOF LED MACHINE WORK LIGHTS

- LED lights provide an excellent solution for heat sensitive environment.
- Color temperature: 6500 K.
- 50,000 hours LED lifetime.
- 4 slots (2 of each side) for bolt-on.
- Hardwire direct to your machine.

IP 65



24V VOLTAGE

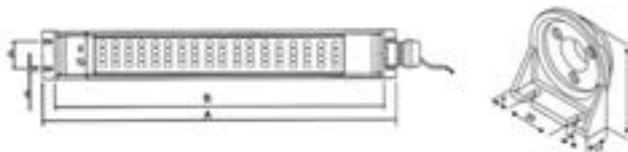

Item#	Input Voltage	Power	Length A/B(mm)	Flux Lm	Price (F)
8401-0470	24V	3.5 W	250/225	33	53.89
8401-0471	24V	7 W	360/335	660	80.81
8401-0472	24V	10.5 W	560/535	990	89.80
8401-0473	24V	14 W	760/735	1320	100.60

Pro-Series IP67 WATERPROOF TUBE LED MACHINE WORK LIGHTS

- IP67 rated water/collant proof.
- LED lights provide an excellent solution for heat sensitive environment.
- Color temperature: 6000~6500 K.
- Uniform distribution of light, excellent lighting effects and no glare.
- Diffusion plate gives high light transmittance and comfortable light for operators.
- 50,000 hours LED lifetime.
- Easy installation and low maintenance.
- High quality IP67 waterproof connector, aluminum PCB, Silicone rubber sealing ring and borosilicate glass tube (60mm Diameter).
- Difficult working temperature: -13°F~131°F(-25°C ~+55°C).
- Hardwire direct to your machine.



IP 67

While Supply Last!

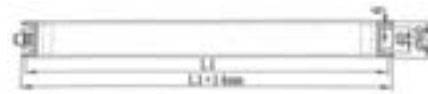

Item#	Power	Power Supply	(mm) Length L	(mm) Length LI	Flux Lm	Price (F)
8401-0491	13 W	110~270V/1 Phase	473	509	1300	156.57
8401-0492	17 W	24V AC/DC	528	564	1700	178.75
8401-0493	20 W	24V AC/DC	668	704	2000	218.06
8401-0494	24 W	24V AC/DC	773	809	2400	252.02

IP65 WATERPROOF HIGH FLUX LED MACHINE WORK LIGHTS

- Bright LED lights provide an excellent solution for heat sensitive environment.
- Color temperature: 6500 K.
- 50,000 hours LED lifetime.
- 4 slots (2 of each side) for bolt-on.
- Hardwire direct to your machine.



IP 65

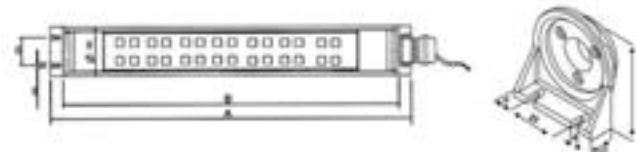

Item#	Input Voltage	Power	Length A/B(mm)	Flux Lm	Price (F)
8401-0477	24V	7.2 W	360/335	720	89.80
8401-0478	24V	11.2 W	560/535	1120	95.80
8401-0479*	110V	16.8 W	760/735	1680	104.76

*Plug Included

SAFETY SHIELD W/DISC MAGNETIC BASE

- Protects eyes from cutting chips
- Universal movement.
- Positively locks all with unique locking mechanism.
- Shield Dimension: 12 x 8"
- Super power disc magnetic base: 2.6" dia. x 0.4" depth.



4401-0517
\$34⁴²
(E)

SAFETY SHIELD WITH UNIVERSAL ARM-Clamp On

- Protects eyes from cutting chips.
- Shield Dimension: 12 x 9".
- Maximum Reach: 21".
- Universal arm can be locked at any positions with 3 knobs.
- Clamp on a shaft or a round bar with 1" diameter or less.

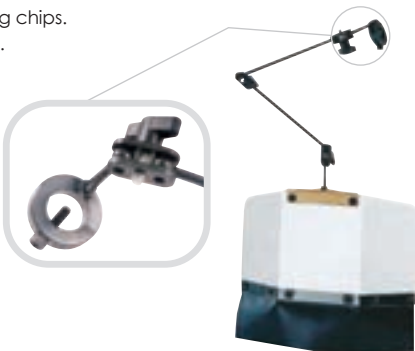

4401-0519
\$43¹⁹
(F)

SAFETY SHIELD WITH MAGNETIC BASE



4401-0518
\$36³³
(F)

- Protects eyes from cutting chips
- Shield Dimension: 12 x 10"
- Magnetic base: 2.5 x 2 x 2".
- Permanent magnet with strong power pull 180 lbs..

MAGNETIC SAFETY SHIELD WITH ADJUSTABLE ARM



- Shield Size: 6 x 8"
- Reach: 12"
- Loc-Line style 3/4" hose, adjustable arm

4401-0516
\$49¹⁸
(E)

MULTI FUNCTION MIST COOLANT SYSTEMS

- Air adjustment valve.
- Fluid control allows for right mixture for every job.
- Flexible tube (18") puts mist right where it is needed.
- For boring, milling, grinding or drilling operations.
- Fits on a standard mag base's vertical post, supplied with set screw to hold location.



WITH MAG. BASE
8401-0195
\$126⁸⁵
(F)

MIST COOLANT
8401-0200
\$104⁴²
(F)

MIST COOLANT SPRAYER ON MAGNETIC BASE



- Air adjustment valve.
- Fluid control allows for right mixture for every job.
- Flexible Loc-Line style tube (17").
- For boring, milling, grinding or drilling operations.
- Magnetic base dimension: 2-5/16"L x 2"W x 2"H
- Magnetice Holding Power: 150 lbs

WITH MAG. BASE
8401-0196
\$151⁸²
(F)

COOLANT HOSE ON MAGNETIC BASE

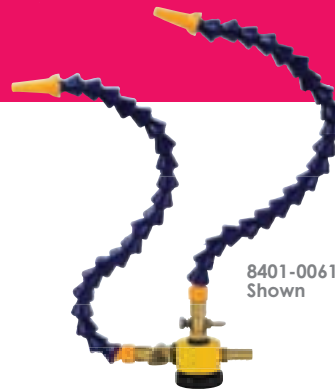

- Low profile magnetic base with 45 lbs power pull.
- Hose Length: 14" optimize coolant use and tool life.
- Shut off valve included.

Item #	Hose	Price (F)
8401-0060	Single	24.95
8401-0061	Dual	31.34

MAGNETIC BASE COOLANT HOSE ASSEMBLY

- 110 lbs magnetic pull.
- Two 1/4" dia. flexible coolant hoses.
- Either one can be shut off.
- On/ Off switchable magnetic base.

8401-0048
\$86⁹³
(F)



COOLANT SYSTEMS

SINGLE STEEL HOSE MAGNETIC BASE COOLANT ASSEMBLY

- Magnetic power pull: 150 lbs.
- Steel flexible hose with metal nozzle.
- Shut off valve.
- Hose length (from valve to tip of nozzle):12.5"
- On/Off switchable magnetic base.

MADE IN TAIWAN

8401-0065

\$7722 (F)



COOLANT TESTER-REFRACTOMETERS

- Accurately measures coolant concentration.
- Includes instructions.
- Optimize coolant use and tool life.
- Just a few drops needed for test.

Item#	Typical Coolant	Solution Measuring Range	Price (F)
8010-0018	Water Sol. or Synthetics	0~20%	101.47
8010-0019	Synthetics	0~15%	101.47
8010-0020	Water Soluble	0~30%	101.47



VERTEX 3 GALLON COOLANT PUMP KIT

- Portable and easy to use coolant device.
- Can be used on drilling, milling machines, small lathes and other equipment that needs cooling.
- Power supply: 110V/1 phase, 1/8 HP.
- Dimension: 15.5 L x 10.5 W x 13" H.
- Weight: 18 lbs

3 Gallon Kit
3012-8110
\$33763 (E)



VERTEX Pro-Series 4.2 & 9-1/4 GALLON COOLANT PUMP KITS

- Portable and easy to use coolant device.
- Can be used on drilling, milling machines, small lathes and other equipment that needs cooling.
- Power supply: 110v/ 1 phase, 1/4 HP.
- Dimension: 19.7 L x 13.8 W x 7.9" H.
- Weight: 73 lbs

- **KIT INCLUDES:**
 - Coolant Pump
 - Coolant Tank
 - Connecting Cable (with plug for 1 ph)
 - Coolant Hose kit with Magnetic Base
 - Flexible Conveying Hose
 - Drain Hose
 - Tool Kits
 - ON/OFF switch (for 1 ph)

MADE IN TAIWAN

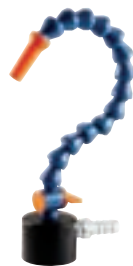

Item#	Coolant Pump (HP x Height)	Tank Size (L x W x H)	Volume of Coolant Tank	Connecting Cable	Coolant Hose Kit with Flexible Conveying Magnetic Base (O x L)	Flexible Conveying Hose (O x L)	Drain Hose (O x L)	Weight	Price (F)
3012-8115	1/8HP x 6"	15.75 x 9.85 x 7.25"	16 liters	7.87"	1/4 x 13"	3/8 x 6"	1 x 11.81"	23.8 lbs.	375.40
3012-8118	1/4HP x 7"	19.68 x 13.75 x 7.87"	35 liters	7.87"	3/8 x 14.17"	3/8 x 6"	1-1/4 x 15.74"	72.75 lbs.	937.74

VERTEX 1/8 HP UNDER WATER COOLANT PUMP

- This pump is high quality with anti-rust treatment, manufactured with high grade materials and inspected in five steps by a precision electronic device.

3012-8122
\$151⁴⁷
(F)

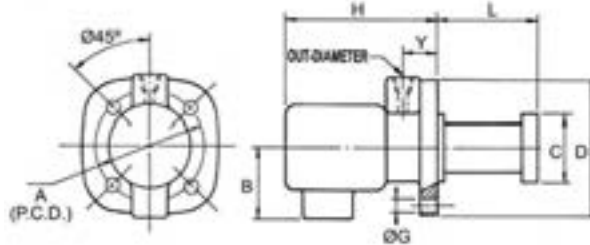
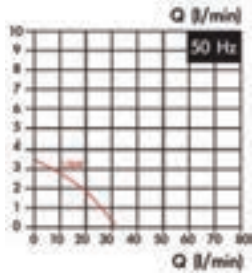

Power	Length (L)	Pumping Water 1mm	Pumping Water 2mm	A	B	C	D	G	H	Y	Out Diameter	Weight
1/8HP	150	27-28 L	25-26 L	128±0.2	105	Ø90	Ø150	Ø8	160	19	PT 3/8"	13 lbs.

VERTEX 1/4 HP UNDER WATER COOLANT PUMP

- This pump is high quality with anti-rust treatment, manufactured with high grade materials and inspected in five steps by a precision electronic device.

3012-8125
\$308¹⁹
(F)

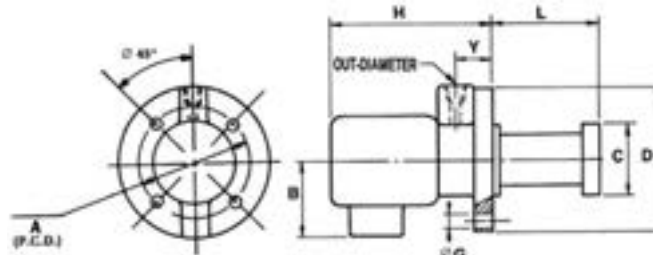
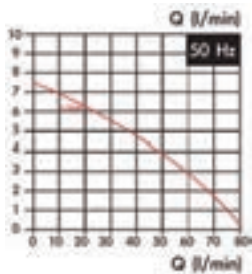

Power	Length (L)	Pumping Water 1mm	Pumping Water 2mm	A	B	C	D	G	H	Y	Out Diameter	Weight
1/4HP	200	74-76 L	71-72 L	158±0.2	125	Ø122	Ø180	Ø8	180	26	PT 1/2"	25 lbs.

VERTEX 1/8 HP SELF PRIMING COOLANT PUMP

- This pump is high quality with anti-rust treatment, manufactured with high grade materials and inspected in five steps by a precision electronic device.

3012-8128
\$176⁹⁷
(F)

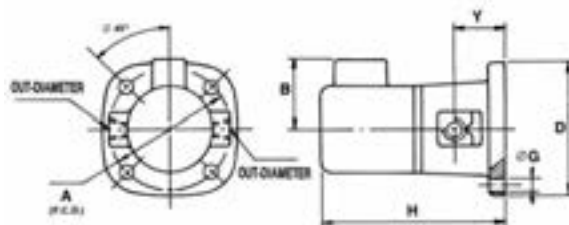
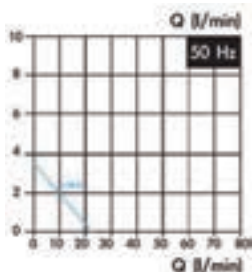

Power	Pumping Water 1mm	Pumping Water 2mm	A	B	D	G	H	Y	In Diameter	Out Diameter	Weight
1/8HP	26-28 L	24-25 L	140±0.2	105	165	Ø8	195	50±0.5	PT 3/8"	PT 3/8"	13 lbs.

ADJUSTABLE COOLANT HOSE SYSTEM

ADJUSTABLE COOLANT HOSE SYSTEM -Loc- Line style - Interchangeable

*Limited Supply

Buy A Pack and Save !

1/4" MALE NPT VALVE KIT
5pc/pack

8401-0209
\$2038
(F)



1/2" MALE NPT VALVE KIT
5pc/pack

8401-0229*
\$2118
(F)

1/4" I.D. COOLANT HOSE KIT, 7PC

8401-0251
\$810
(F)



1/2" I.D. COOLANT HOSE KIT, 7PC

8401-0502
\$1104
(F)

INCLUDES:
1/16, 1/8 & 1/4" Nozzle
and 1/8 & 1/4" NPT Connector
6" x 2pc Coolant Hose

INCLUDES:
1/4, 3/8 & 1/2" Nozzle
and 1/2 & 3/8" NPT Connector
6" x 2pc Coolant Hose

1/4" IN-LINE VALVE KIT
5pc/pack

8401-0210*
\$3235
(F)



1/2" IN-LINE VALVE KIT
5pc/pack

8401-0230*
\$3350
(F)

6" LENGTH, 1/4 COOLANT HOSE SET
2pc/pack

8401-0211
\$426
(F)

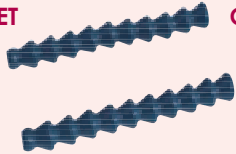

6" LENGTH, 1/2 COOLANT HOSE KIT
5pc/pack

8401-0231*
\$1098
(F)

1/4" I.D. COOLANT HOSE KIT, 7PC

8401-0253
\$1399
(F)



INCLUDES:
1/16, 1/8 & 1/4" Nozzle
1" Flare Nozzle and 3/8 SAE Flare Nut Adapter
6" x 2pc Coolant Hose

1/4" "Y" FITTING KIT
5pc/pack

8401-0202*
\$577
(F)



1/2" "Y" FITTING KIT
5pc/pack

8401-0222*
\$916
(F)

1/4" ELBOW FITTING KIT
5pc/pack

8401-0203*
\$680
(F)



1/2" ELBOW FITTING KIT
5pc/pack

8401-0223*
\$941
(F)

4PC 90° 1/4" NOZZLE KIT
(1/16, 1/8, 1/4" & Spray Bar)

8401-0208*
\$384
(F)



4PC 90° 1/2" NOZZLE KIT
(1/16, 1/8, 1/4" & Spray Bar)

8401-0228*
\$598
(F)

3PC (1/16, 1/8 & 1/4") ROUND NOZZLE SET

8401-0204
\$545
(F)



3PC (1/4, 3/8 & 1/2") ROUND NOZZLE SET

8401-0224*
\$1000
(F)

NPT 1/4" CONNECTOR KIT
5pc/pack
For 1/4" hose

8401-0207
\$495
(F)



NPT 3/8" CONNECTOR KIT
5pc/pack
For 1/2" hose

8401-0227*
\$753
(F)

NPT 1/8" CONNECTOR KIT
5pc/pack
For 1/4" hose

8401-0206*
\$405
(F)



NPT 1/2" CONNECTOR KIT
5pc/pack
For 1/2" hose

8401-0226*
\$964
(F)

50FT BULK COOLANT HOSE COILS -Loc- Line style - Interchangeable

1/2 INCH
8401-0240*
\$37691
(F)

*Limited Supply

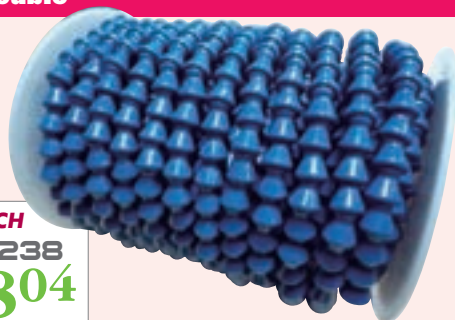

1/4 INCH
8401-0220
\$25779
(F)

3/8 INCH
8401-0238
\$34804
(F)

COOLANT HOSE WRENCHES

• Use for easy assembly of coolant hoses.



Works with Loc-Line!

HEAVY DUTY

1/4" Hose
8401-0504
\$2454
(E)

1/2" Hose
8401-0506
\$2454
(E)

5PC FLARING NOZZLE KITS

- Interchangeable with LoLine.
- For flexible hose system.

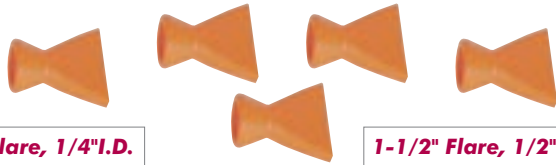

1" Flare, 1/4" I.D.
8401-0205
\$580
 (F)

1-1/2" Flare, 1/2" I.D.
8401-0225*
\$1000
 (F)

*Limited Supply

AIR SANDER - Orbital Jitterbug Type

- Constant orbital stroke for fine finishing.
- Dynamic counter weight for low vibration sanding.
- Automatic throttle release lever with positive stop action.
- Pad Size: 3-2/3" x 6-1/2".
- Speed: 8,000 RPM
- Air Inlet: 1/4" NPT.
- Hose Size: 3/8".
- Air Consumption: 5 CFM.
- Air Pressure: 90 PSI.

7600-0118
\$7006
 (F)

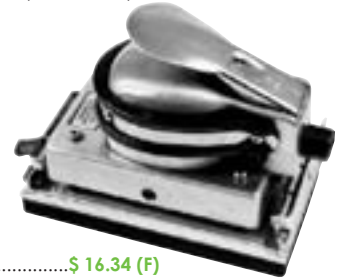

Replacement Pad (Item #7600-0119).....\$ 16.34 (F)

Pistol Type AIR DUSTER BLOW GUNS -Heavy Duty



Limited Supply!

- Body made of Aluminum Casting for long lasting durability.
- Max. Working Pressure: 180 psi
- Comfort trigger design
- Quick coupling connector included

Gun with 5/8" Tube
7600-0191
\$1065
 (F)

Gun with 4" Tube
7600-0192
\$1151
 (F)

1/8" ECONOMY MINI AIR DIE GRINDER

SPECIFICATIONS

Free Speed (RPM).....	54,000
Air Inlet (NPT).....	1/4"
Collet chuck.....	1/8"
Air pressure (PSI).....	.90
Length.....	5-1/4"
Weight.....	1/4 lbs

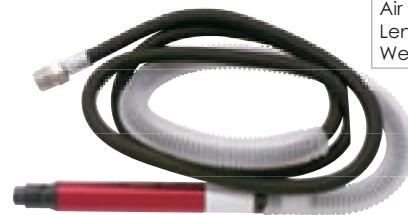

7600-0086
\$4431
 (F)

Pro-Series 1/8" MINI AIR DIE GRINDER

- Pen type is ideal for access to confined areas
- Operates at 54,000 RPM at 90 PSI
- Includes 1/8" collet, wrenches and quick connect coupler

MADE IN TAIWAN

7600-0088
\$20223
 (F)

SPECIFICATIONS

Free Speed (RPM).....	54,000
Air Inlet (NPT).....	1/4"
Collet chuck.....	1/8"
Air pressure (PSI).....	.90
Length.....	5-1/4"
Weight.....	1/4 lbs



SUPPLIED WITH WATER/OIL SEPARATOR

AIR BLOW GUN & SET

SET INCLUDES:

- 1 - Blow gun with rubber tip
- 3 - Safety extension tubes
- 1 - Male tip

5 PC SET
7600-0170
\$955
 (F)



BLOW GUN ONLY

7600-0169
\$568
 (F)

360 DEG. PNEUMATIC HOSE FITTING & COUPLING

- Made of Aluminum Alloy
- Swivel 360°
- Max. Working Pressure: 140 psi
- Thread: 1/4 NPT x 1/4 NPT (Male x Female)

Limited Supply!

8401-0249
\$999
 (F)



5PC 1/4" QUICK - COUPLER SET

- SET INCLUDES:
- 1 - NPT female quick connector
- 1 - NPT female/male stud
- 3 - Male/male stud

7600-0171
\$444
 (F)



Z-Limit ERGONOMIC LOW NOISE 1/4" AIR DIE GRINDER KIT



- Rubber molded cushion grip
- Air regulator on top
- Safety throttle lever
- Rear exhaust with silencer
- 360 degree swivel air inlet
- Low noise 79 dB(A)
- Free Speed: 20,000 RPM
- Air Inlet: 1/4" NPT
- Hose Size: 3/8"
- Air Pressure: 90 PSI
- Air Consumption: 4 CFM
- Overall Length: 7-3/8"

Kit Includes:

- 1-Air Die Grinder
- 5-1/4" Shank Mounted Stone
- 5-1/8" Shank Mounted Stone
- 1-Fitted Blow Case

MADE IN TAIWAN

7609-0901
\$8470
 (F)

Limited Supply!



AIR TOOLS & ACCESSORIES

1/4" MINI AIR DIE GRINDER

- Light weight construction
- Ball bearing construction
- Variable speed throttle



SPECIFICATIONS	
Speed (RPM).....	22,000
Air Inlet (NPT).....	1/4"
Collet chuck.....	1/4"
Length.....	4"

7600-0902
\$19²²
(F)

1/4" ECONOMY AIR DIE GRINDER

7600-0089
\$28⁶⁰
(F)



SPECIFICATIONS	
Speed (RPM).....	22,000
Collet chuck.....	1/4"
Air inlet(NPT).....	1/4"
Hose size (ID).....	3/8"
Air Consumption.....	4 CFM
Air-pressure (PSI).....	90
Overall Length.....	7-3/8"

1/4" HEAVY DUTY AIR DIE GRINDER

- Heavy Duty.
- Built in Safety Lever to meet OSHA requirements.
- Variable speed throttle for positive speed control.
- Ball bearing construction for long tool life.
- Rear exhaust.

HHP
PRO-SERIES



SPECIFICATIONS	
Speed (RPM).....	22,000
Collet chuck.....	1/4"
Air inlet(NPT).....	1/4"
Hose size (ID).....	3/8"
Air-pressure (PSI).....	90

7600-0911
\$55⁸⁶
(F)

ABRASIVE CUT-OFF WHEEL MANDRELS

CAUTION: Never exceed maximum RPM rating. Always use a guard and comply with ANSI B7.1.



2PC ARBOR SET
3900-6376

\$8⁵⁸
(F)

1/4 & 3/8"

Item#	Arbor	Shank	Price (F)
3900-6250	1/4"	1/4"	4.48
3900-6375	3/8"	1/4"	4.48

Z-Limit ERGONOMIC LOW NOISE 1/4" MINI AIR DIE GRINDER

- Rubber molded cushion rip
- Air regulator on top
- safety throttle lever
- Rear exhaust with silencer
- Free speed: 25,000 RPM
- Low noise 79 dB
- Air inlet: 1/4 NPT
- Hose size: 3/8"
- Air Pressure: 90 PSI
- 360° swivel air inlet.
- Air Consumption: 4 CFM
- Overall Length: 6-1/4"
- Weight: 1 lbs.

Limited Supply!

Z-Limit
ULTRA-SERIES

7609-0902
\$60⁵⁰
(F)



MADE IN TAIWAN

Z-Limit ERGONOMIC LOW NOISE 1/4" AIR DIE GRINDER

- Rubber molded cushion grip
- Air regulator on top
- Safety throttle lever
- Rear exhaust with silencer
- 360 degree swivel air inlet
- Low noise 79 dB(A)
- Free Speed: 20,000 RPM
- Air Inlet: 1/4" NPT
- Air Pressure: 90 PSI
- Air Consumption: 4 CFM
- Overall Length: 7-3/8"
- Hose Size: 3/8"
- Weight: 1.5 lbs

Z-Limit
ULTRA-SERIES

7609-0903
\$86¹³
(F)



MADE IN TAIWAN

Z-Limit ERGONOMIC LOW NOISE 1/4" ANGLE AIR DIE GRINDER

- Rubber molded cushion grip
- Air regulator on top
- Safety throttle lever
- Rear exhaust with silencer
- 360 degree swivel air inlet
- Low noise 77 dB(A)
- Free Speed: 20,000 RPM
- Collet Size: 1/4"
- Air Inlet: 1/4" NPT
- Hose Size: 3/8"
- Air Pressure: 90 PSI
- Air Consumption: 4 CFM
- Overall Length: 6-11/16"
- Weight: 1.1 lbs

Z-Limit
ULTRA-SERIES

7609-0904
\$106⁴³
(F)



MADE IN TAIWAN

REPLACEMENT COLLETS

- Fits all air tools with same collet size

Item#	Chuck Size	Fits Air Tool	Price (F)
7600-1003	1/8"	1/8"	12.27
7600-1001	1/8"	1/4"	8.65



1/4" ECONOMY ANGLE AIR DIE GRINDER

- Collet size: 1/4".
- Air inlet: 1/4".
- I.D. air hose: 3/8".
- 90 PSI air pressure.
- 20,000 RPM speed.
- 4 CFM air consumption.
- Built in Safety Lever to meet OSHA requirements.

7600-0093
\$54.40 (F)



1/2" DRIVE AIR IMPACT WRENCH



- Bolt capacity.
- Maximum torque: 250ft/lbs.
- 90 PSI air pressure.
- 5 CFM air consumption.
- 7000 RPM speed.

7600-0942
\$567.60 (F)

1/4" ANGLE AIR DIE GRINDER

- Built in Safety Lever to meet OSHA requirements.
- Collet size: 1/4".
- Air inlet: 1/4".
- I.D. air hose: 3/8".
- 90 PSI air pressure.
- 20,000 RPM speed.
- 4 CFM air consumption.

HHIP PRO-SERIES

7600-0092
\$72.20 (F)



MADE IN TAIWAN

Z-Limit 3/8" ERGONOMIC LOW NOISE AIR RATCHET WRENCH

- Rubber molded cushion rip
- Rear exhaust with silencer
- Low noise 79 dB
- Free speed: 150 RPM
- Maximum torque: 60 ft/lbs

- Air inlet: 1/4 NPT
- Air Pressure: 90 PSI
- Air Consumption: 4 CFM
- Overall Length: 10-3/8"
- Weight: 2.8 lbs.

Z-Limit
ULTRA-SERIES

3/8" DRIVE
7609-0931
\$87.12 (F)

Limited Supply!



MADE IN TAIWAN

Pro-Series 3/8" REVERSIBLE AIR DRILL

- Rubber molded cushion rip
- Rear exhaust with silencer
- Composite motor housing.
- Variable speed trigger
- Standard keyless chuck.
- Free speed: 2,000 RPM
- Chuck Size: 3/8"
- Spindle Thread: 3/8"-24
- Air Inlet: 1/4 NPT
- Hose Size (ID): 3/8"
- Air Pressure: 90 PSI
- Air Consumption: 4 CFM
- Overall Length: 7-5/8"
- Weight: 2.2 lbs.

Z-Limit
ULTRA-SERIES

Limited Supply!

7609-0095
\$72.60 (E)

MADE IN TAIWAN



HEAVY DUTY 3/8" REVERSIBLE ANGLE AIR DRILL

- 90° angle head.
- Rear exhaust, low noise
- Forward and reverse knob.
- Variable speed lever.
- Standard keyed chuck.
- Free speed: 1,200 RPM
- Chuck Size: 3/8"
- Spindle Thread: 3/8"-24

- Air Inlet: 1/4 NPT
- Hose Size (ID): 3/8"
- Air Pressure: 90 PSI
- Air Consumption: 4 CFM
- Overall Length: 8"
- Weight: 2.5 lbs.

Limited Supply!

7609-0098
\$103.40 (E)

MADE IN TAIWAN



PUSH TO CONNECT FITTINGS

PUSH TO CONNECT MALE TUBE FITTINGS

- Max. Air Pressure: 0-10 kgf/cm²
- Metal body, nickel plated
- Pre applied teflon thread sealant
- Temperature: -5~60 °C
- Push-in tube to connect

Limited Supply!



Item#	Tube OD	Pipe Thread	Overall Length (mm)	Price (F)
8401-0275	1/8	NPT 1/8	20	1.47
8401-0276	1/8	NPT 1/4	20	1.99
8401-0280	1/4	NPT 1/8	22	1.50
8401-0286	3/8	NPT 1/8	30	3.94
8401-0287	3/8	NPT 1/4	31	3.98
8401-0288	3/8	NPT 3/8	29	2.90

PUSH TO CONNECT MALE TUBE ELBOW FITTINGS

- Max. Air Pressure: 0-10 kgf/cm²
- Thermo plastic body, nickel plated metal thread side.
- Pre applied teflon thread sealant
- Temperature: -5~60 °C
- Push-in tube to connect

Limited Supply!



Item#	Tube OD	Pipe Thread	Length A (mm)	Length C (mm)	Price (F)
8401-0294	1/8	NPT 1/8	24.9	18	1.99
8401-0295	1/8	NPT 1/4	26.9	18	2.94
8401-0298	1/4	NPT 1/8	27.3	20	2.59
8401-0299	1/4	NPT 1/4	29.3	20	3.11
8401-0300	1/4	NPT 3/8	30.3	20	2.99

NPT SINTERED BRONZE EXHAUST MUFFLERS

- Max. Air Pressure: 0-10 kgf/cm²
- Metal body, nickel plated
- Temperature: -20~70°C
- Decibel Rating: 75.000



Item#	NPT Thread	Hex Size (mm)	Overall length	Price (F)
8401-0320	1/8	12	0.94"	1.77
8401-0321	1/4	16	1.23"	3.16
8401-0322	3/8	18	1.47"	3.59
8401-0323	1/2	24	1.72"	7.44

NPT SINTERED BRONZE EXHAUST MUFFLERS

- Exhaust & Intake mufflers
- Metal body, nickel plated Breather Vent
- Temperature: -20~70°C



Item#	NPT Thread	Hex Size (mm)	Overall length	Price (F)
8401-0328	1/8	12	0.45"	1.70
8401-0329	1/4	16	0.55"	1.86

4 WAY HAND OPERATED VALVES-ROTARY DISC TYPE

- Body made of Aluminum Alloy
- Max. Working Pressure: 150 psi
- Number of Positions: 3
- Actuator Type: Lever/Detent



Item#	Inlet Size (Inch)	CV Rating	Price (F)
8401-0255	3/8	1.83	48.83
8401-0256	1/2	1.83	48.83

5 WAY HAND OPERATED VALVES-LEVER TYPE

- Body made of Aluminum Alloy
- Max. Working Pressure: 120 psi
- Number of Positions: 2
- Actuator Type: Lever/Detent

Limited Supply!



Item#	Inlet Size (Inch)	Outlet Size (Inch)	CV Rating	Price (F)
8401-0260	1/4 NPT	1/4 (2) & 1/8 (2)	0.67	33.90

3 WAY MANUAL MECHANICAL VALVE

- Body made of Aluminum Alloy
- Max. Air Working Pressure: 250 psi
- Number of Positions: 2

Limited Supply!



Item#	Inlet Size (Inch)	Outlet Size (Inch)	CV Rating	Price (F)
8401-0263	1/4 NPT	1/4 NPT	0.89	28.16

4&6 PORT STRAIGHT CONNECTION MANIFOLDS

- Body made of Aluminum Alloy
- Max. Working Pressure: 120 psi
- Number of Positions: 2
- Inlet Size: 1/4 NPT
- Outlet Size: 1/4 NPT

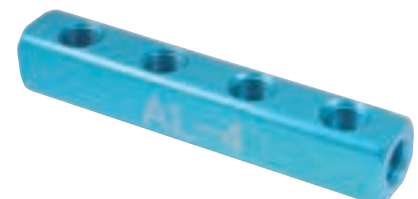

Item#	Port	Width x Height	OAL	Price (F)
8401-0310	4	0.85 x 0.85"	5"	13.92
8401-0312	6	0.85 x 0.85"	7"	21.45



1 PC FILTER/REGULATOR UNIT WITH DRAIN

- Max. Working Pressure: 150 psi
- Max. temperature: 70°C
- Manual drain type.
- Bowl Capacity: 25 ml (included)
- Pressure Gauge Included, 1/8 NPT mounting
- Dimensions: 2.5 x 3 x 7.4"

Heavy Duty!

Limited Supply!

Item#	Inlet Size (Inch)	Outlet Size (Inch)	Price (F)
7600-1755	1/8 NPT	1/8 NPT	52.99
7600-1756	1/4 NPT	1/4 NPT	52.99

1 PC FILTER/REGULATOR UNIT WITH DRAIN

- Max. Working Pressure: 150 psi
- Max. temperature: 70°C
- Manual drain type.
- Bowl Capacity: 25 ml (included)
- Pressure Gauge Included, 1/8 NPT mounting
- Dimensions: 2 x 3 x 6"

Limited Supply!

Clear Bowl



Item#	Inlet Size (Inch)	Outlet Size (Inch)	Price (F)
7600-1760	1/8 NPT	1/8 NPT	25.59
7600-1761	1/4 NPT	1/4 NPT	25.59

3PC FILTER/REGULATOR/LUBRICATOR UNITS

- Max. Working Pressure: 150 psi
- Max. temperature: 70°C
- Manual drain type.
- Dimensions: 5.4 x 3 x 5.2"
- Bowl Capacity: 15 ml & 25 ml (included)
- Pressure Gauge Included, 1/8 NPT mounting

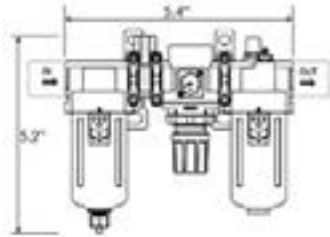

Limited Supply!



Item#	Inlet Size (Inch)	Outlet Size (Inch)	Price (F)
7600-1770	1/8 NPT	1/8 NPT	51.17
7600-1771	1/4 NPT	1/4 NPT	51.17

2PC FILTER/REGULATOR/LUBRICATOR UNIT

- Max. Working Pressure: 150 psi
- Max. temperature: 70°C
- Manual drain type.
- Bowl Capacity: 25 ml (included)
- Pressure Gauge Included, 1/8 NPT mounts.
- Dimensions: 3.5 x 3 x 6.2"



Limited Supply!

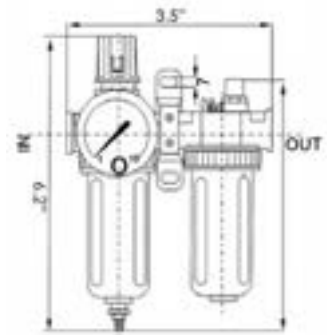

Item#	Inlet Size (Inch)	Outlet Size (Inch)	Price (F)
7600-1765	1/8 NPT	1/8 NPT	44.99

ELECTRICAL (P.V.C.) TAPE



Limited Supply!

3/4" x 60 FT.
8070-0015
\$9.68 (F)

PRICED AND SOLD BY 10PC/PACK

TEFLON TAPE



1/2" x 520 FT.
8070-0003
\$9.05 (F)

PRICED AND SOLD BY 10PC/PACK

SHOP APRON

- 14 oz. heavy denim apron
- 1 side pocket & 1 two part big pocket



28" Wide x 36" Long
8070-7004
\$7.59 (F)

Markal PRO-LINE FINE TIP MARKERS

For Precision Marking

- Fine tip sizes (2mm) for precise, permanent paint marking.
- High-strength, lightweight barrel designed for industrial-grade use.
- Ideal for metal, also suitable for wood, glass, plastic, rubber and more.
- Xylene-Free for less odor.
- Self-storing cap with clip protects tip for longer life and stores easily in pocket.



Color	Item#	Price (E)	Color	Item#	Price (E)
White	8030-9671	6.44	Blue	8030-9675	6.44
Yellow	8030-9672	6.44	Green	8030-9676	6.44
Black	8030-9673	6.44	Orange	8030-9677	6.44
Red	8030-9674	6.44			

ITW DYKEM BRITE-MARK MARKERS

- Makes permanent marks on metal, rubber, plastic, glass, concrete, leather, stone, wood, vinyl and more
- Valve action mechanism prevents paint in barrel from drying when cap is left off
- Heavy-duty aluminum barrel retains its shape
- Felt tips are replaceable to assure complete use of paint in each marker
- Drying time 25-35 seconds



For Marking On Any Surface! REGULAR (Medium) LINE

Item#	Color	Case Qty	Price (E)
8030-8401	Blue	48	6.13
8030-8402	Black	48	6.13
8030-8403	White	48	6.13
8030-8404	Yellow	48	6.13
8030-8405	Orange	48	6.13
8030-8406	Red	48	6.13
8030-8407	Green	48	6.13
8030-8408	Silver	48	6.13
8030-8409	Gold	48	6.13

ITW DYKEM HI-SPOT BLUE

Hi-Spot is an intensely blue, soft uniform paste that spreads easily and evenly to show high spots on bearings. A thin coating may be left on the surface day in and day out, and will not dry. The film remains pliable and transferable and in condition for months.

- Non-drying
- Non-hardening
- Transfers from one surface to another

.55 OZ. TUBE
8030-8355
\$12.99
 (E)



WELDER'S ANGLE VISES

- Brass lead screw & nut.
- One piece structure.
- 90° angle

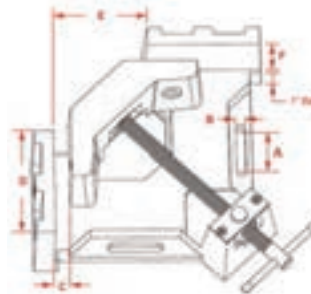

Item#	Jaw Length D	Jaw Height F	Jaw Opening C	A	B	E	Price (F)
3900-1724*	4"	1-3/8	2-3/8	1.77"	0.51"	2.95"	63.10
3900-1725	5"	2-3/8	4	2.56"	0.59"	3.15"	99.95

*Limited Supply

7 WAY MIG WELDING PLIER

- Small serrated hole for mig tips.
- Flat surfaces for light hammering.
- Wire cutter for trimming mig wire.
- Spring loaded handle with heavy insulated grip for comfort.
- Needle nose grip wire for pulling
- Large serrated hole for nozzles.



8080-0026
\$15.24
 (F)

ALNICO POT MAGNETS

- Tapped hole in the center
- Made in Taiwan
- Magnetic circuit design for strong holding



Limited Supply!

Item #	Size(mm) Dia. x H	Hold Power	Tapped Hole	Wt. Lbs	Price (F)
4401-0820	30 x 25	40 lbs.	M6 x 1.00	0.26	16.49
4401-0822	40 x 30	66 lbs.	M8 x 1.25	0.57	27.76
4401-0824	50 x 40	110 lbs.	M8 x 1.25	1.20	44.27

MAGNET HOLDER

- Tapped hole in the center
- Made in Taiwan
- Strong holding power
- Useful



Limited Supply!

Item #	Size(mm) L x W x H	Hold Power	Tapped Hole	Wt. Lbs	Price (F)
4401-0816	26 x 60 x 25	44 lbs.	M6 x 1.0	0.70	29.72

HEAVY DUTY DEMAGNETIZER

- Demagnetizes tools such as dies, cutters and punches.
- Operates on 115V AC with on/off switch, 80 W.
- Table Size: 7.14" W x 5.00" L x 4.00 H

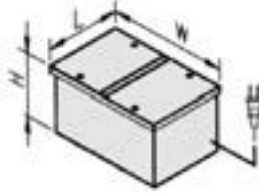

3401-0602
\$8705
(F)



Pro-Series HEAVY DUTY DEMAGNETIZER

- Demagnetizes general parts, tools such as dies, cutters and punches.
- Operates on 115V AC, 1 Phase, 2A Current with on/off switch.
- **Automatic Temperature Protection:** Power cuts off when reaches certain setting point. It will restart once it cools down (cycle time 10-20min).
- Table Size: 7.1" W x 5.0" L x 3.5" H
- New Weight: 9 lbs.



MADE IN TAIWAN



3401-0601
\$31725
(F)

17 PC POWER PUNCH KIT

- Complete with 7 sets of punches and dies.
- Common sizes: 3/32", 1/8", 5/32", 3/16", 7/32", 1/4", 9/32".
- Punches and dies hardened to HRC 50-52.
- Pierces up to 16-gage metals. (steel, aluminum, brass, copper, plastic, etc.).
- Curved handles for a natural, balanced grip.
- Supplied with plastic carry case.

7070-0016
\$6211
(E)



HEAVY DUTY TAPE MEASURE

- Made of heavy duty sheet metal steel.
- One inch wide blade.
- Hold up to 8' no break.
- Shows fraction by 8ths.
- Durable rubber outfit for easy grip



FRACTION SCALE

1" x 25 FT.
7020-0025
\$629
(E)

Dasqua® DIGITAL METRIC LASER TAPE MEASURES



- Measuring Accuracy: ±3mm
- Laser Class: 2
- Laser Type: 620-690nm, <1mW
- Operating Temperature: 0-40°C
- Storage Temperature: -20-70°C
- Display Type: OLED
- Multi-line Display: 2 lines
- Display Color: white on black
- Battery Life: 2000 measurements
- Battery Type: 3.7V Li-ion
- Laser Auto Off: After 30 seconds
- Power Auto Off: After 90 seconds
- 80.4mm x 46.4mm (with buckle)
- Tape width 2.5cm
- USB charging capability

- 3 in 1: tape measure, laser measure, digital display of tape
- 2 in 1: tape measure, laser measure

Item#	Measuring Range	Accuracy	Type	Price (F)
1804-1080	0.05-30m/5m	±3mm	3in1	112.16
1804-1055	0.05-30m/5m	±3mm	2in1	80.70

STAMPS & PUNCH SETS

STEEL STAMP COMBO SETS

- Hardened to RC 59-61 at tip and tempered to RC 40 Rockwell at striking end.
- Made from carbon steel.
- Character style designed to give sharp clear impressions.
- Packed in durable box.
- Easy selection and storage.



SET INCLUDES:

Numbers (0-9), Letters (A-Z)

Item#	Size of Impression	Price (F)
8016-0002	1/8"	10.56
8016-0003	3/16"	15.84
8016-0004	1/4"	20.67
8016-0005	3/8"	34.14



Pro-Series 36PC NUMBER/LETTER STEEL STAMP KITS

- Sand blasted surface finish.
- Kit consists of A-Z letters & 0-9 numbers.
- Made of high grade tool steel, each character is hardened and tempered to 60-62 HRC.
- Heavy duty plastic case.

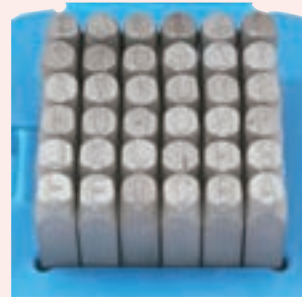

Item#	Size of Impression	Price (F)
8016-0012	1/8"	16.49
8016-0013	3/16"	17.63
8016-0014	1/4"	21.38
8016-0015	3/8"	57.75

OPTICAL PUNCH SET

- This Optical Punch Set is indispensable when doing critical layout work. Just look down the magnifying lens and align the cross hairs with the mark on your workpiece. Replace the magnifier with the supplied punch and give it a tap.
- Punch set Includes 3 components a bull's eye and cross hair lens, a 120 degree made of tempered steel, a precisely manufactured of aluminum main body and a fitted case..



8600-4120
\$69.22 (E)

Lens Magnifier Power: 9x
Punch Size: 3/8"
Pin Length: 1.85"

MACHINISTS' BENCH BLOCK

- Made from steel-hardened and ground
- A handy tool for holding work when driving pins, drilling, etc.
- The knurled side provides a good gripping surface
- V-groove across the face accommodates round and odd shaped stock
- Holes from 1/8 to 5/8 (3-16mm) diameter

3600-0042
\$33.18 (F)

3" Dia. x 1-1/2" H



OPTICAL PUNCH SET & 4PC CENTER DRILL SET COMBO KIT

- This Optical Punch Set is indispensable when doing critical layout work. Just look down the magnifying lens and align the cross hairs with the mark on your workpiece. Replace the magnifier with the supplied punch and give it a tap.
- Punch set Includes 3 components a bull's eye and cross hair lens, a 120 degree made of tempered steel, a precisely manufactured of aluminum main body and a fitted case.
- 4pc HSS combined drill & countersink set: #1-#4
- Made of high speed steel and ground.
- Plain style.
- Use for centering work ends, where the workpiece is to be revolved on machine centers, 60° countersink angle fits at standard centers.

Lens Magnifier Power: 9x
Punch Size: 3/8"
Pin Length: 1.85"

NEW



Specifications

Size	Body Dia	(Inch) Drill Dia	OAL
1	1/8	3/64	1-1/4
2	3/16	5/64	1-7/8
3	1/4	7/64	2
4	5/16	1/8	1-1/8

Combo Kit
8600-4122
\$73.92 (F)

DISC CUTTER SETS

- Punches are made of tool steel, case-hardened.
- The top and bottom plates are made of durable shock-resistant tool steel through hardened for long-wear.
- Round disc cutters let you cut perfectly round discs in up to 1mm (18 gauge) thick metal sheets.
- Slide metal between the plates and, with a mallet or heavy hammer of your choice, hit once for best results.



INCH, 7PC Set
8606-4127
\$59.40 (F)

7PC INCLUDES DISC SIZES: 1/4, 5/16, 3/8, 7/16, 1/2, 9/16 & 5/8"

Block Size: 2.44x2.42x0.98"
Punches Length: 1.50"



METRIC, 14PC Set
8606-4130
\$96.80 (F)

14PC INCLUDES DISC SIZES: 3.0, 4.5, 5.0, 6.0, 7.0, 7.5, 8.0, 8.5, 10.0, 11.0, 12.0, 13.0, 14.0 & 16.0mm
Block Size: 4.20x1.93x0.93"
Punches Length: 1.55"

8PC DRIVE PIN PUNCH SET

- Manufactured from fine tool steel hardened and tempered.
- Knurled body.
- Complete with vinyl pouch.
- Overall length: 4"

SET INCLUDES:
1/16, 3/32, 1/8,
5/32, 3/16, 7/32,
1/4 & 5/16"

8PC Set
8606-4106
\$1566
(F)



8PC BRASS DRIVE PIN PUNCH SET

- Used in spark-free environments.
- Made from brass hexagonal stock.
- Punch section centerless ground.
- Supplied in plastic pouch.
- 3-1/2" overall length.
- Punch tip diameters are oversized approximately 0.005" (0.127mm).
- Set Includes: 1/16(1.6mm), 3/32(2.4mm), 1/8(3.2mm), 5/32(4.0mm), 3/16(4.8mm), 7/32(5.5mm), 1/4(6.4mm) & 5/16"(8.0mm)



8PC Set
8600-4110
\$2508
(F)

8PC DRIVE PIN PUNCH SETS

- Tool steel heat treated, ground and polished.
- Knurled body.
- Complete with vinyl pouch.
- Overall length: 4"

8 PC SET INCLUDES:
1/16~1/4" by 32nds & 5/16"



8PC Set
8600-4107
\$4225
(F)

8PC Set
8600-4106
\$1732
(F)

8PC BRASS DRIVE PIN PUNCH SET

- Used in spark-free environments.
- Punch section centerless ground.
- Solid brass.
- Hexagonal body
- 4" length.
- Supplied in fitted case.

8PC Set
8600-4108
\$4165
(F)



13PC COMBINATION DRIVE PIN PUNCH SET

- Tool steel heat treated, ground and polished.
- Knurled body.
- Complete with vinyl pouch.

SET INCLUDES:
8 pc. 4" length 1/16-5/16" and
5 pc. 8" length 1/8, 3/16, 1/4,
5/16 & 3/8" in vinyl pouch.

13PC Set
8606-4113
\$2595
(F)



NEW

METAL SCRIBER

- Tempered and heat treated steel all over body, handle, and sharp tips.
- Long length handy for hard to reach holes.
- Knurled body for tight grip.

OAL: 9.50"

7600-4302
\$278
(F)



SCRIBER WITH CLIP

- For marking or engraving on hard metal, glass, plastic, ceramic, jewelry, etc.
- Sharp tungsten steel tip.
- Convenient pocket clip and covered cap.
- Knurled body grip.

7600-0044
\$259
(F)



5PC EXTRA-LONG DRIVE PIN PUNCH SETS

- Black nitrate finish.
- Alloy steel hardened on both ends.
- Finger grip knurled body.
- Pin length: 3-1/2".
- Overall length: 8".
- Complete with vinyl pouch.

5 PC SET INCLUDES:
1/8, 3/16, 1/4, 5/16 & 3/8"

5PC Set
8600-4103
\$1568
(F)

5PC Set
8600-4104
\$4118
(F)



5" AUTO CENTER PUNCH

- No hammer required.
- Double spring loaded barrel.
- Special hardened alloy steel tip for instant marking.
- Knurled body.



8070-0482
\$807
(F)

TRANSFER SCREWS & DAPPING BLOCKS

25PC TRANSFER SCREW COMBO SETS

- Convenient & economic combination of four sizes often used together.
- More accurate than transfer punches. The fastest and most precise method of transferring threaded holes to mating parts. Great for tool and die work and in lay outs.
- Solid handle.
- Plastic storage case.



3601-0511 Shown

SET INCLUDES:

Handle & 24 Screws(6pc each size)



3601-0513 Shown

Item#	Set Thread	Price (F)
3601-0511	1/4-20, 5/16-18, 3/8-16, 7/16-14	38.45
3601-0513	1/2-13, 5/8-11, 3/4-10, 9/16-12	48.47
3601-0515	10-24, 8-32, 6-32, 4-40	45.99
3601-0517	M3x0.5, M4x0.7, M5x0.8, M6x1.0	39.60
3601-0519	M6x1.0, M8x1.25, M10x1.50, M12x1.75	35.36
3601-0521	M14x2.00, M16x2.00, M20x2.50, M24x3.00	58.20

7 PC TRANSFER SCREW SETS

- More accurate than transfer punches. The fastest and most precise method of transferring threaded holes to mating parts. Great for tool and die work and in lay outs.

SET INCLUDES: Handle & 6 Screws

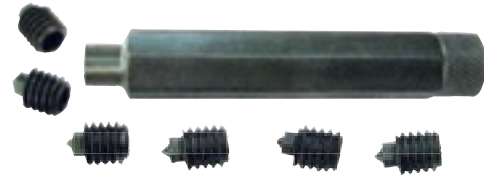

Inch

Item#	Thread	Price (F)
3601-0004	4-40	12.93
3601-0006	6-32	13.53
3601-0008	8-32	12.99
3601-0010	10-24	12.99
3601-0011	10-32	13.30
3601-0012	12-24	11.28
3601-0250	1/4"-20	11.50
3601-0312	5/16-18	11.76
3601-0375	3/8"-16	11.50
3601-0376	3/8"-24	12.51
3601-0438	7/16"-14	12.29
3601-0500	1/2"-13	11.50
3601-0501	1/2"-20	11.23

MM

Item#	Thread	Price (F)
3601-1003	M3x0.5	11.88
3601-1004	M4x0.7	13.87
3601-1005	M5x0.8	14.43
3601-1006	M6x1.00	14.78
3601-1008	M8x1.25	14.78
3601-1010	M10x1.50	14.85
3601-1012	M12x1.75	14.73

40PC DAPPING DIE BLOCK & PUNCH SET

- Ideal for multi purpose formings.
- Made of hardened steel.
- Steel Dapping Block 2.5x2.5x2.5"(20 Depressions: 2.0, 3.2, 4.8, 6.4, 7.9, 9.5, 11.1, 12.7, 14.3, 15.9, 17.5, 19.1, 20.6, 22.2, 25.4, 27.0, 28.6, 31.8, 34.9, 44.5 & 50.8mm)
- Steel Flat Dapping Block: 5"x2.5"x1"(27 Depressions: 1.5, 2.0, 2.4, 2.8, 3.2, 3.6, 4.4, 4.8, 5.6, 6.4, 7.1, 7.9, 8.7, 9.5, 10.7, 11.1, 12.7, 14.3, 15.5, 15.9, 17.1, 17.5, 19.1, 20.6, 22.2, 23.8 & 25.4mm)
- Steel Forming Block: Half Round (18 Grooves 4-22mm).
- Forming block (60 x 60 x 50 mm): Constructed of hardened steel. It is with half-round, flat and right-angle grooves. It has different shaped grooves on all sides for shaping metals.
- 36pc Dapping Punches(3.5" Long): 3.5, 4.0, 4.5, 5.0, 5.5, 6.0, 6.5, 7.0, 7.5, 8.0, 8.5, 9.0, 9.5, 10.0, 10.5, 11.0, 11.5, 12.0, 12.5, 13.0, 13.5, 14.0, 14.7, 15.4, 16.2, 17.0, 17.8, 18.6, 19.4, 20.2, 21.0, 21.8, 22.6, 23.4, 24.2 & 25.0mm
- Wooden stand with index included.

SET INCLUDES:

- 1pc Dapping Block,
- 1pc Flat Dapping Block
- 1pc Steel Half Round Forming Block
- 1pc Flat&Right Angle Forming Block
- 36pc Punches

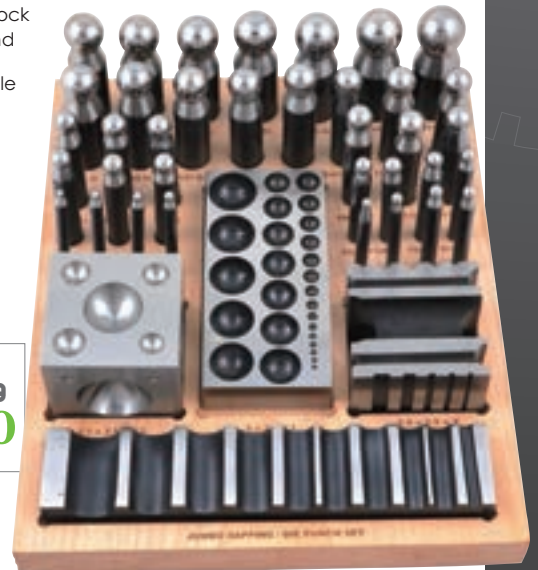

40PC Set
8606-3409
\$173.80
 (F)

DAPPING DIE BLOCKS - Steel & Brass

- 2x2" block has 18 half-sphere depressions from 4 - 40 mm in diameter.
- 3x3" block has 9 half-sphere depressions from 22 - 62.5 mm in diameter.
- Ideal for doming soft metals with the use of dapping punches or arbor presses and making beads and shaping metals.



Steel 2x2x2" Shown

18 Sizes: 4,5,6,7,8,9,10,11,12,13,14, 16,18,20,25,30,35,40mm



Brass 3x3x3" Shown

9 Sizes: 22,25,28,32,38,45,50,60 & 62.5mm

Block Size	Dapping Size	Steel Item#	Price (F)	Brass Item#	Price (F)
2" x 2"	4,5,6,7,8,9,10,11,12, 13,14,16,18,20,25,30, 35,40mm	8606-3400	18.68	8606-3410	44.00
3" x 3"	22,25,28,32,38,45, 50,60 & 62.5mm	8606-3402	65.12	8606-3412	105.60

TRANSFER PUNCH SETS

- Undersize .0025"
- Heat treated tempered tool steel for longer life.
- Black oxide finish.
- Used for transferring of threaded, drilled and tapped holes.

28 PC SET
Range: 3/32-1/2" x 64ths
8600-0041
\$ **25¹⁹**
(F)



33 PC SET
Range: 1/2-1" x 64ths
8600-0411
\$ **103³⁴**
(F)



Item#	No. of Pieces	Range	Price (F)
8600-0041	28	3/32-1/2" x 64ths & 17/32"	25.19
8600-0411	33	1/2-1" x 64ths	103.34
8600-0043	25	1-33mm x 0.5mm	21.45
8600-0044	26	A-Z	23.96
8600-0045	60	#1-60	32.80

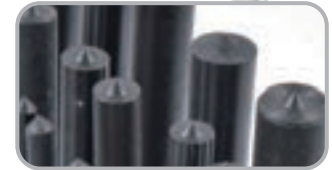

REPLACEMENT RACKS FOR TRANSFER PUNCH SETS

- **Rack only.**
- Metal rack with sizes marked.

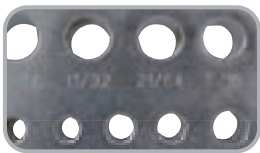

28PC Rack Shown

Item#	Description	Price (F)
8600-0041R	28PC Rack: 3/32-1/2" x 16ths	4.97
8600-0411R	33PC Rack: 1/2-1" x 64ths	11.12

24PC DAPPING DIE BLOCK & PUNCH SET

- Ideal for making beads and shaping metals.
- Dapping block(2x2") has 18 half-sphere depressions from 2.3 - 25 mm in diameter.
- 24pc Dapping Punches(3.5" long): 2.3, 3.5, 4.3, 5.1, 5.9, 6.7, 7.5, 8.3, 9.1, 9.9, 10.7, 11.5, 12.3, 13.0, 13.8, 14.6, 15.4, 16.2, 17.0, 18.6, 20.2, 21.8, 23.4 & 25.0mm.
- Hardened tool steel.
- Ideal for foming soft metals with the use of dapping punches or arbor presses.

SET INCLUDES:
Dapping Block, 24pc Punches
& Wood Stand with Index.

Metric, 24PC Set
8606-3406
\$ **70⁴⁰**
(F)



61PC TRANSFER PUNCH COMBO SET

- Used for transferring threaded, drilled and tapped holes.
- Undersize .0025"
- Heat treated tempered tool steel for longer life.
- Black oxide finish.
- 28pc Set Range: 3/32~1/2" by 64ths & 17/32"
- 33pc Set Range: 1/2-1" by 64ths

28PC & 33PC COMBO SET

Range: 3/32~1"
8600-0050
\$ **112⁹⁹**
(F)



BUY COMBO SET & SAVE!

108 PC BLIND HOLE SPOTTER SET

- Fast, easy way to locate opposite centers. When holes do not extend through material (such as holes for dowel pins, perforating punches, etc.) Blind-hole spotters get the job done simply. Correct size spotter can be used in threaded, drilled or reamed holes.



8016-0108
\$ **110²⁴**
(F)



INCLUDES:
1/8 to 21/32" by 32nds, 6pc each

HAMMERS & COUNTERS

Pro-Series PU-DEAD BLOW HAMMERS

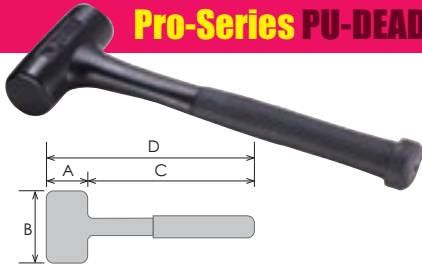

MADE IN TAIWAN

- Advanced Polyurethane (PU) material will not mar surfaces or absorb liquids.
- Basic: Steel structure and include steel shot.
- Absorbs shock from impact reduces rebound and maximizes force due to steel shot filled canisters.
- Grip is synthetic rubber improving grip and comfort.

Item#	Size OZ	A (mm)	B (mm)	C (mm)	D (mm)	Price (E)
7080-0331	18	38	100	249	287	19.97
7080-0333	24	46	100	260	306	22.39
7080-0336	33	50	110	290	340	27.95
7080-0339	49	60	130	308	368	37.80

DEAD BLOW HAMMERS

- Shot loaded interior produces a powerful driving force.
- Tough, durable polypropylene casting.
- Resistant to industrial chemicals.
- Non-marring, non-sparking.



Item#	Size (lbs.)	Head Dia.(In)	Overall Length	Price (F)
7080-0291	1	1-3/4	12"	16.53
7080-0292	2	2	13-1/2"	18.00
7080-0293	3	2-1/2	14-1/2"	23.69
7080-0294	4	3-1/2	15"	29.58

BRASS HAMMERS FIBERGLASS HANDLE

- Industrial grade.
- Non-Marring, non-sparking.
- Polished high purity brass heads.



Item#	Size (lbs.)	Head Dia.(In)	Overall Length	Price (F)
7080-0036	1	1-1/8	11-1/2"	39.22
7080-0037	1-1/2	1-1/4	12-1/2"	57.10

RATCHET DIGITAL READOUT COUNTER

- Reset knob.
- Base: 2-1/8 x 1-3/4".
- 5 digits.
- Height: 1-1/4".

3900-0203
\$10⁵³
(F)



HANDHELD 4 DIGIT COUNTER

- Chrome plated
- 2" Height x 1-3/4" Width
- Finger ring for easy handling
- Supplied with steel base

3900-0204
\$9¹⁸
(F)



NYLON FACE DEAD BLOW HAMMERS

- Shot loaded interior produces a powerful driving force.
- Nylon material strike faces.
- Resistant to industrial chemicals.
- Non-marring, non-sparking.



Replacement Tip

Item#	For Size (OZ.)	Price (E) Each
7080-0310	12	2.70
7080-0311	20	4.68



Item#	Size (OZ.)	Head Dia. A	Head Length B	Overall Length D	Price (E)
7080-0300	12	1.0"	4"	11"	14.09
7080-0301	20	1.5"	4"	11.5"	27.23

DEAD BLOW HAMMERS - UPE PLASTIC

- Shot loaded interior produces a powerful driving force.
- UPE material strike faces.
- Resistant to industrial chemicals.
- Non-marring, non-sparking.



Replacement Tip

Item#	Size (OZ.)	Head Dia.(In)	Overall Length	Price (E)	Item#	For Size (OZ.)	Price (E) Each
7080-0302	16	1.2	11"	26.92	7080-0312	16	4.94
7080-0305	29	1.6	11.8"	32.81	7080-0315	29	6.96
7080-0308*	46	2.2	12.6"	42.13	7080-0318*	46	9.22

* Limited Supply

FIBERGLASS HANDLE BALL PEIN HAMMERS

Limited Supply!

Item#	Size (oz.)	Price (F)
7080-0202	12	6.40
7080-0022	32	11.48
7080-0231	48	14.39

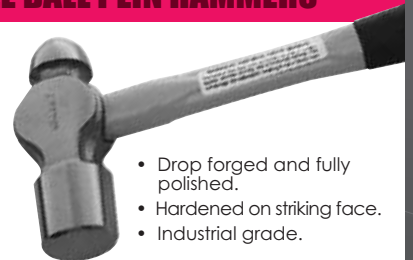

- Drop forged and fully polished.
- Hardened on striking face.
- Industrial grade.

HEAVY DUTY TIE DOWN

- Heavy duty ratchet tie down.
- Quick automatic release.
- Safe and secure type.

Limited Supply!

Item#	Size (W x L)	Capacity (lbs)	Price (F)
8010-0002	1" x 15 ft.	1,000	4.51
8010-0001	2" x 27 ft.	6,500	22.99



WINDOW DIRECT READOUT TORQUE WRENCH

- Meets or exceeds ISO 6789, US Fed. GGG-W-686D & ANSI B107.14M.
- Chrome-vanadium ratchet gear (32 teeth) and fully heat treated handle.
- Patented unique pull-push system, micro-click & reversible.
- Dimension: Width of Head 1.4", Depth of Head 1.23", OAL 19.5"
- Release accuracy $\pm 3\%$
 - Push locking.
- Window scale design for easy reading.
- With fitted case.

1/2" DRIVE

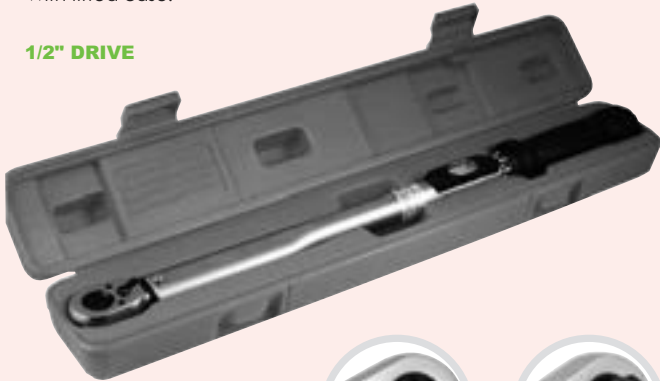

Item#	Drive	Torque Range	Graduation	Price (E)
7020-0151	1/2"	120~150 ft/lbs (30-210Nm)	10ft/lbs	145.68

MICROMETER TORQUE WRENCHES

- Dual scale torque wrench.
- Micrometer adjusting, reversible ratcheting.
- Complete with conversion table chart.
- Lock holds torque setting.
- Chrome plated alloy steel.



**1/2" DRIVE
TORQUE RANGE**
7020-0150
\$4084
(F)

10-150 ft./lbs (1.4-20.7 m/kg)

9PC T-HANDLE TORX KEY SET

- Industrial grade heat treated extrude S-2 alloy steel.
- PVC coated handles provide a non-slip grip.
- Arm reach: 7-1/2".
- Complete with vinyl pouch.

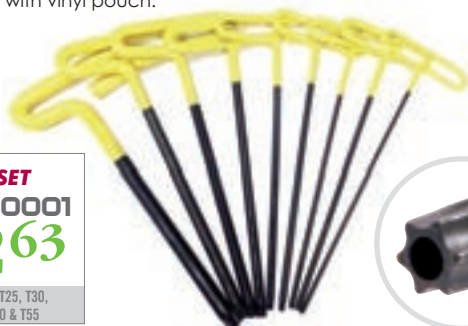

9 PC SET
7900-0001
\$2263
(F)

T10, T15, T20, T25, T30,
T40, T45, T50 & T55

COMBINATION WRENCHES

- Polished heads and raised panel.
- Forged steel.
- Open end and 15° offset box opening.



Inch

Item#	Size	OAL	Price (F)
7023-1001	1/4	4	2.06
7023-1002	5/16	4.6	2.70
7023-1003	3/8	4.8	2.67
7023-1004	7/16	4.5	3.23
7023-1005	1/2	5.9	4.35
7023-1006	9/16	6.3	4.66
7023-1008	5/8	6.7	5.41
7023-1009	11/16	7.5	5.96
7023-1010	3/4	8.2	8.18
7023-1011	7/8	10.6	8.59
7023-1012	15/16	11	10.97
7023-1017	1	10.7	11.53
7023-1018	1-1/16	13.6	16.91
7023-1019	1-1/8	13	20.75
7023-1191	1-3/16	15	21.30
7023-1020	1-1/4	13.4	22.68
7023-1021	1-5/16	16.8	23.72
7023-1022	1-3/8	17.5	27.17
7023-1023	1-7/16	18	27.56
7023-1024	1-1/2	18.7	30.77
7023-1025	1-5/8	19.6	32.43
7023-1026	1-11/16	20.2	32.75
7023-1027	1-3/4	21.2	33.50
7023-1028	1-13/16	22.7	34.44
7023-1029	1-7/8	22.4	38.97
7023-1030	2	23.5	44.13
7023-1031	2-1/8	24.2	75.24
7023-1032	2-1/4	25	84.69
7023-1033	2-3/8	26	85.27
7023-1034	2-1/2	26.7	100.72

MM

Item#	Size	OAL (Inch)	Price (F)
7023-2012	6	4.2	1.71
7023-2013	7	4.4	1.85
7023-2014	8	4.2	2.37
7023-2015	9	4.8	2.57
7023-2051	10	4.4	3.45
7023-2052	11	4.6	3.55
7023-2016	12	5.7	4.44
7023-2053	13	5.8	4.50
7023-2017	14	6.3	4.75
7023-2018	15	8	5.00
7023-2020	16	8	5.41
7023-2021	17	7.6	5.50
7023-2022	18	8.6	5.75
7023-2023	19	8.3	6.17
7023-2024	20	10	6.77
7023-2025	21	10	7.56
7023-2054	22	10.8	9.01
7023-2026	23	11.3	9.03
7023-2027	24	11.5	11.52
7023-2028	25	12.5	11.75
7023-2030	26	13.5	14.61
7023-2031	27	12.3	14.75
7023-2034	28	14.8	15.00
7023-2035	29	14.8	15.33
7023-2036	30	13.3	21.55
7023-2038	32	13.5	26.66
7023-2040	34	16.4	27.00
7023-2042	36	17	27.50

COMBINATION WRENCH SETS

- Forged chrome plated tool steel.
- All sets fully polished.
- With pouch.



14 PC SET
3/8~1-1/4"
7023-0005
\$7686
(F)

3/8, 7/16, 1/2, 9/16, 5/8, 11/16, 3/4,
13/16, 7/8, 15/16, 1, 1-1/16, 1-1/8, 1-1/4"

15 PC SET
6~24MM
7023-0006
\$5621
(F)

6, 7, 8, 9, 10, 11, 12, 13, 14, 15, 17,
19, 21, 22, 24mm

HANDLES & KNOBS

ADJUSTABLE HAND LEVER WAND KNOBS -Hex Head

- Handle Material: Plastic (KT)



Item#	Female Thread	Hex (mm)	Handle Length L	Price (F)
8017-0048	M6X1.5	14	1.65"	3.65
8017-0051	M8X1.25	14	2.83"	5.05
8017-0053	M10x1.5	16	3.62"	5.51

LEVER WAND KNOBS-Push to Screw On

- Handle Material: Plastic (KT)



Item#	Thread x Length	Handle Length (mm)	Price (F)
8017-0060	M6x20mm	43	2.73
8017-0061*	M6x20mm	63	2.60
8017-0063	M6x30mm	43	2.73
8017-0064	M6x30mm	63	3.42
8017-0066	M6x45mm	43	2.96
8017-0070	M8x15mm	83	4.18
8017-0071	M8x30mm	63	3.42
8017-0073	M8x40mm	83	4.50
8017-0076	M10x20mm	83	4.50

*Limited Supply

REVOLVING HANDLES

- Handle Material: Bakelite (KU)



Item#	Thread x Length	Handle Length (mm)	Handle Dia (mm)	Price (F)
8017-0080	M8x13mm	56	20	1.83
8017-0082	M8x13mm	76	22	2.29
8017-0085	M10x13mm	56	20	1.83
8017-0086	M10x13mm	76	22	2.29
8017-0087	M10x13mm	83	25	2.73

FLAT END HANDLES, REVOLVING

- Material: Steel
- Fits most movable handwheels

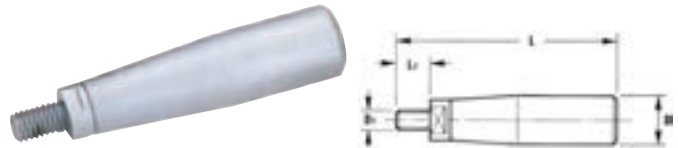

Item#	Thread D1	Dimensions (mm)			Price (F)
		D	L1	L	
8017-0001	M10X1.5	23	16	100	10.37
8017-0002	3/8"-16	22	16	99	10.37

ELLIPSE END HANDLES, REVOLVING

- Material: Steel
- Fits most movable handwheels

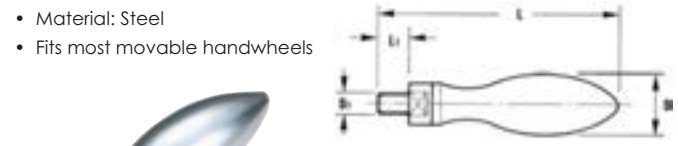

Item#	Thread D1	Dimensions (mm)			Price (F)
		D	L1	L	
8017-0010	M6x1.0	16	7	60	9.49
8017-0011	M8x1.25	20	9	80	9.49
8017-0012	M10x1.5	26	13	110	11.52
8017-0016	3/8"-16	25	13	99	10.37

ADJUSTABLE FACE SPANNER WRENCHES

NEW

- Ideal for adjusting collars, lock nut rings & bearings
- Black finish.

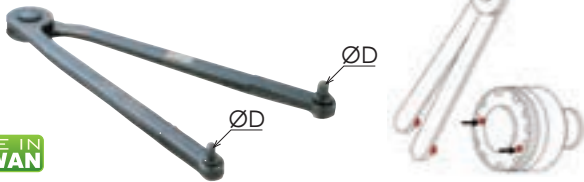

MADE IN TAIWAN

Item #	Pin Hole Dia. D	(mm) Length	Adj. Range Between Pins	Price (F)
7016-0040	3.0	7.5	7-40	12.67
7016-0042	4.0	7.3	11-60	12.67

KNURLED KNOBS

- Ideal for adjusting collars, lock nut rings & bearings
- Black finish.

NEW



Item#	Thread	Base Dia.	Diameter	Price (F)
8017-0120	10-24NC	3/4"	5/8"	2.60
8017-0123	1/4"-20NC	1"	3/4"	3.96
8017-0125	3/8"-16NC	1-1/4"	1-1/8"	6.36

KNOB HAND

- Material: KT plastic
- Thread: M8x1.25, 0.83" length
- Knob: 1.6" diameter, 2.6" Length.

8017-0042
\$3.65 (F)



BALL KNOBS

- Material: Bakelite (KU)



Item#	Diameter (mm)		Thread	Price (F)
	Ball	Thread		
8017-0030	25	M6	2.29	
8017-0032	25	M8	2.29	
8017-0033	38	M8	2.73	
8017-0035	38	M10	2.73	
8017-0037	38	M12	2.73	
8017-0038	42	M12	4.35	

SAFETY SWIVEL HOIST RINGS

200% PROOF-LOAD TESTED AND CERTIFIED WITH TRACEABLE SERIAL NUMBER

- Swivels 360° - pivots 180°
- Material: Alloy Steel
- Safety factor: 5:1
- Finish: Black Oxide (Also available: Cadmium Plated, Electroless Nickel Plated, Zinc Plated)
- Magnetic partical inspected.
- Certified heat treatment.
- Rated at 100% from 0° to 90°
- Fatigue tested to 20,000 cycle at 1.5 times the rated load
- Thread: Longer Projection and Fine Threads Available.
- Comforms to CE.
- **Meets or exceeds the requirements of ASME B30.26**

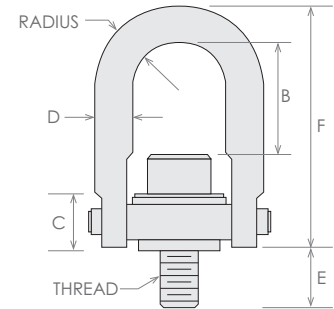
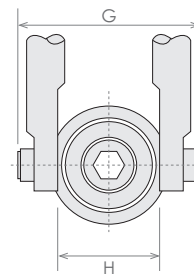

INCH THREAD

Rated Loads(Lbs)	Thread Size	A	C	D	E	Standard U-Bar Item#	B	F	G	H	Torque Ft/#	Wt. (Lbs)	Price (D)
600	1/4~20	0.43	0.71	3/8	0.54	8004-6100	1.27	2.67	1.84	1.00	6	0.3	149.35
800	5/16~18	0.43	0.71	3/8	0.54	8004-6104	1.27	2.67	1.84	1.00	7	0.3	128.65
1,000	3/8~16	0.43	0.71	3/8	0.54	8004-6106	1.27	2.67	1.84	1.00	12	0.3	128.65
2,500	1/2~13	0.70	0.93	1/2	1.07	8004-6602	1.84	3.77	2.58	1.49	28	1.0	156.58
2,500	1/2~13	0.88	1.22	3/4	0.78	8004-6008	2.31	4.78	3.52	1.99	28	2.6	156.58
4,000	5/8~11	0.88	1.22	3/4	1.03	8004-6004	2.18	4.78	3.52	1.99	60	2.6	156.58
5,000	3/4~10	0.88	1.22	3/4	1.03	8004-6014	2.06	4.78	3.52	1.99	100	3.0	156.58
7,000	3/4~10	1.40	1.71	1	1.54	8004-6206	3.06	6.52	5.14	3.00	100	7.0	342.13
8,000	7/8~9	1.40	1.71	1	1.04	8004-6202	2.93	6.52	5.14	3.00	160	7.0	342.13
10,000	1~8	1.40	1.71	1	1.29	8004-6210	2.81	6.52	5.14	3.00	230	7.5	342.13
10,000	1-1/8~7	1.40	1.71	1	2.29	8004-6216	2.69	6.52	5.14	3.00	230	7.5	482.35
10,000	1-1/8~8	1.40	1.71	1	2.29	8004-6217	2.69	6.52	5.14	3.00	230	7.5	482.35
15,000	1-1/4~7	1.75	2.11	1-1/4	1.89	8004-6802	4.12	8.73	6.50	3.76	470	14.0	551.43
20,000	1-3/8~6	2.00	2.40	1-1/2	2.50	8004-6702	5.50	10.20	7.46	4.31	540	23.0	636.05
24,000	1-1/2~6	2.25	2.81	1-3/4	3.20	8004-6404	6.41	12.47	8.55	4.87	800	34.0	702.83
24,000	1-3/4~5	2.25	2.81	1-3/4	3.20	8004-6408	6.16	12.47	8.55	4.87	800	34.0	993.85
30,000	2~4-1/2	2.25	2.81	1-3/4	3.20	8004-6400	5.91	12.47	8.55	4.87	800	36.0	826.85
50,000	2-1/2~4	3.00	4.09	2-1/4	4.00	8004-7006	8.03	16.87	11.67	6.52	2100	88.0	2,408.31

STAINLESS STEEL AVAILABLE.

METRIC THREAD

Rated Loads(Lbs)	Thread Size	A	C	D	E	Standard U-Bar Item#	B	F	G	H	Torque Ft/#	Wt. (Lbs)	Price (D)
400	M8x1.25	11	18	10	13	8004-6912	32	68	47	25	9	0.4	142.64
500	M10x1.50	11	18	10	18	8004-6916	30	68	47	25	16	0.4	142.64
1,050	M12x1.75	18	24	13	27	8004-6608	48	96	66	38	37	1.0	170.43
1,050	M12x1.75	22	30	19	19	8004-6924	60	121	89	51	37	2.5	171.90
1,050	M14x2.00	22	30	19	29	8004-6928	58	121	89	51	40	2.5	190.80
1,900	M16x2.00	22	30	19	29	8004-6930	56	121	89	51	80	2.7	190.80
2,150	M20x2.50	22	30	19	34	8004-6936	52	121	89	51	135	6.7	190.80
3,000	M20x2.50	36	43	25	32	8004-6942	78	166	131	76	135	7.0	406.37
4,200	M24x3.00	36	43	25	37	8004-6948	74	166	131	76	311	15.0	365.75
7,000	M30x3.50	45	54	32	42	8004-6956	106	222	165	95	637	15.0	621.75
7,000	M33x3.50	45	54	32	67	8004-6960	103	222	165	95	637	23.0	695.70
10,000	M33x3.50	50	62	38	58	8004-6961	140	259	189	109	637	35.0	924.28
11,000	M36x4.00	57	71	44	63	8004-6966	166	317	217	124	1085	36.0	822.86
12,500	M42x4.50	57	71	44	83	8004-6968	160	317	217	124	1085	38.0	896.06
13,500	M48x5.00	57	71	44	83	8004-6970	154	317	217	124	1085	38.0	960.08
13,500	M56x5.50	57	71	44	88	8004-6973	154	317	217	124	1085	38.0	1,192.62
22,300	M64x6.00	76	103	57	101	8004-6972	204	428	296	165	2847	86.0	2,484.63

STAINLESS STEEL AVAILABLE.

48" PAN & BOX BRAKE

- 48" width is suitable for many metal forming operations.
- Hardened steel box fingers are easily removed or repositioned.
- Left and right beam control levers for easy operation.
- Large contour balanced brake handle for brake past 90° to 135°.
- Ruggedly built.

SPECIFICATIONS	
Capacity (mild steel).....	16 gauge
Brake range.....	0~135°
No. of finger.....	2"/5, 3"/6, 4"/5
Footprint.....	52" x 12"
Weight.....	368 lbs.



8600-4032
\$1,241⁵⁸
 (E)

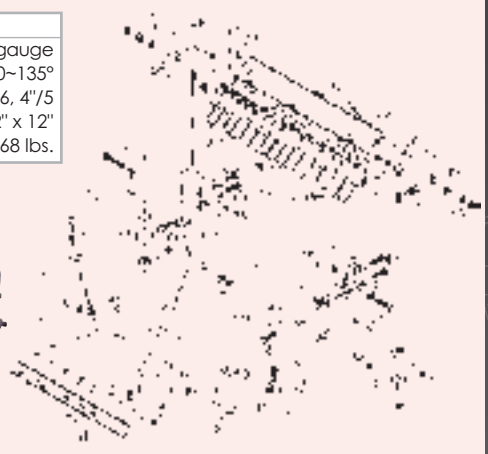

HEAVY DUTY BENCH GRINDERS

- Direct drive motor with no brushes or belts to adjust or replace
- Permanently lubricated motor bearings
- Adjustable shatter-resistant plastic eye shields
- Removable wheel covers for easier wheel changes
- Free speed: 3,500 RPM
- Adjustable tool rests
- Power: 110 V/ 1Phase
- 6' wire cord
- UL approved

COLOR MAY VARY

6", 1/2 HP
 7600-0030
\$127⁷⁷
 (F)

8", 3/4 HP
 7600-0028
\$150⁴⁰
 (F)



PEDESTAL STAND FOR BENCH GRINDERS

- For 6, 8 & 10" grinders
- Base for Grinder : 9-3/4 x 9-3/4"
- Overall height: 34"
- Weight: 22 Lbs.
- Coolant tank and adjustable tool tray.

8071-0034
\$102⁷⁴
 (F)



HEAVY DUTY PEDESTAL BENCH GRINDER STAND

- Designed to accommodate 6", 7", 8", and 10" bench grinders and bench buffers, and 1", 2" and 4" belt grinders.
- Base and top are made of heavy-duty cast iron
- Top size: 10-5/8x10-5/8"
- Steel column is 3-1/2" diameter
- Adjustable height water pot provides quenching for work piece.
- Unique design allows mounting with 4 bolts, Mounting slots are 1/2" width & mounting holes are 1/2" diameter.
- Stand Height: 33"
- Pedestal leg length: 9.5"
- Weight: 58 lbs.

8071-0035
\$171⁸³
 (F)



DELUXE HEAVY DUTY DIGITAL MULTIMETER

- 1" height digit LCD display.
- AC current 200mA/100μA, 20A/10 mA.
- AC voltage up to 750V/1 V.
- DC voltage up to 1000V/1V.
- DC current 200μA/100mA, 200mA/100μA, 20A/10mA.
- Data-held & diode test feature.
- LCD back light for dark places easy reading.
- Single standard 9-volt battery (not included).
- Resistance up to 200 mΩ
- Test leads.
- Logic test.
- Auto power off.

8070-0403
\$36³⁰
 (E)



Limited Supply!

DIGITAL MULTIMETER

- Power: single standard 9V battery (not included).
- 200 mA range continuity indication.
- LCD display with max. 1999 reading.
- DC/AC voltage to 750V.

8070-0400
\$9³⁴
 (E)

Limited Supply!



MINI UNIVERSAL BENDER - Forms Wire, Flat Metal & Tubing

- Forms wire, flat metal and tubing into clamps, handles, brackets, hooks, coils and more.
- Makes sharp angle bends up to 5/16" diameter rod and 1"x1/8" flat metal.
- Made of hardened tool steel.
- Mounts on a work bench or held in a vise.

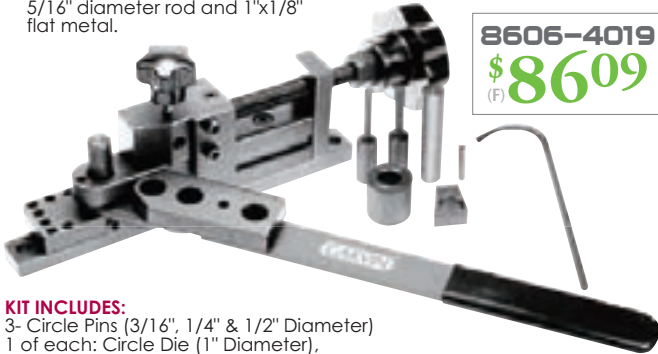

8606-4019
\$8609
(F)

KIT INCLUDES:

3- Circle Pins (3/16", 1/4" & 1/2" Diameter)
1 of each: Circle Die (1" Diameter),
Stop Pin & Sharp Angle Die

TUBE NOTCHERS

- Operated on tubes with up to .118" wall thickness for steel.
- Advantage for joining and welding of tubes at a 90° angle.
- One device covers several tube diameters.
- Horizontal and vertical operation.
- Suitable for double-connections.

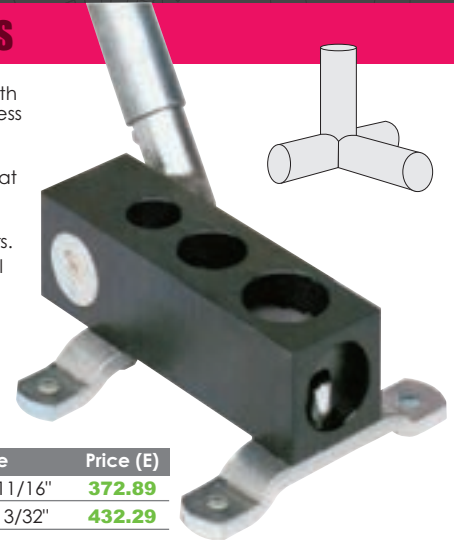

Item#	Range	Price (E)
8600-4046	1-1/16 ~ 1-11/16"	372.89
8600-4047	1-7/8 ~ 2-13/32"	432.29

8" BENCH METAL SHEAR

- Heavy duty structure.
- Can be used to cut sheet steel, steel bars and rods.
- Small and unique device for convenient site working.
- An adjustable hold-down clamp aids in securing material.

Limited Supply!



Item#	Blade Length	Capacity to Cut Round (Dia)	Plate	Wt. (lbs.)	Price (F)
8600-4005	8"	1/2"	1/4"	38	149.00

HEAVY DUTY ARBOR PRESSES

- Heavy duty frame.
- Precision made.
- 4 position steel anvil.
- Steel pinions.



Item#	Press (Ton)	Max. A	Press Ht. G	Base ExF	Capacity Over Table C	Capacity Over Anvil D	Ram	Wt. (lbs)	Price (F)
8600-0031	1/2	3.54"	10.24"	4.35 X 9.53"	4.33"	3.62"	3/4"	24	70.95
8600-0032	1	4.29"	13"	5.04 x 10.63"	5.63"	4.84"	1"	35	109.03
8600-0033	2	4.52"	17.72"	6.77 x 16.93"	8.44"	7.68"	1-1/4"	91	271.67
8600-0035	5	7.87"	33.67"	10.95x25.59"	18.76"	17.72"	2"	360	1,186.90

HHIP HEAVY DUTY ARBOR PRESSES



- Heavy duty frame.
- Precision made.
- 4 position steel anvil.
- Steel pinions.

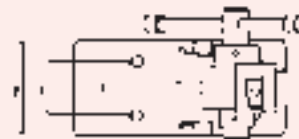

Item#	Press (Ton)	A	B	Capacity Over Anvil C	(Inch) Capacity Over Table	D	E	F	Anvil H	Wt. (lbs)	Price (F)
8600-1031	1/2	10.20	9.25	2.95	3.69	3.54	2.36	4.17	2.68	18	91.08
8600-1032	1	12.80	10.63	3.94	4.68	4.92	2.95	5.12	3.35	33	132.84
8600-1033	2	17.91	16.93	5.91	6.68	6.50	3.94	6.50	4.72	69	285.54

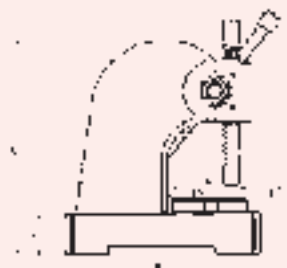

ARBOR PRESSES

Pro-Series ARBOR PRESSES-With 3PC Punch Set

- For riveting, squeezing, punching, bending, and other pressing applications.
- Base drilled for mounting on bench or pedestal.
- Sturdy, cast-iron construction.
- Removable machined steel anvil provides accurate work support in four slot positions.
- Rugged steel ram is driven by machined pinion.
- Punches or tools may be added to the end of the ram with the aid of a magnetic insert.

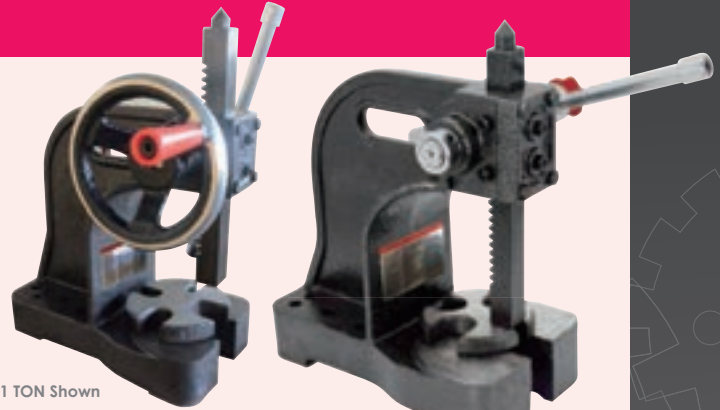

1 TON Shown

3 TON Shown

Item#	Press (Ton)	High Speed Wheel	Max. D	Press Ht. A	Capacity Over Anvil C	Anvil Dia. H	Ram B	E	J	Weight (lbs)	Price (F)
8600-0130	1/2	No	3.3"	11"	4.6"	3-1/2	3/4"	9.5"	5	20	75.06
8600-0131	1	Yes	4"	14"	5.5"	4-1/2	1"	16"	8	2-1/8	122.09
8600-0132	2	No	6"	18"	8.52"	6-3/4	1-1/4"	18"	9-1/2	3-1/8	280.62
8600-0133	3	No	9"	36"	18"	6-3/4	1-1/2"	21"	10	4	448.31

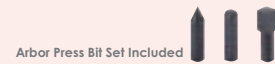

RATCHET LEVER ARBOR PRESSES

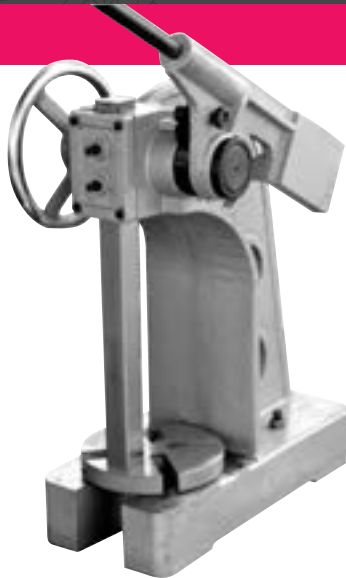

- Ratchet device permits lever to be used in most convenient position.
- Heavy-duty casting frame.
- 4-position anvil.
- Hand wheel advances ram to work quickly.



RATCHET TYPE

Item#	Capacity (Ton)	Height of Press G	Max. A	Arbor	Ram	Capacity Over Anvil D	Base E x F	Weight (lbs)	Price (F)
8600-3301	2	18-1/2"	6"	1-7/8"	1/1/4"	8-1/2"	11.0x17.3"	86	302.90
8600-3401	3	21-1/2"	6"	1-3/4"	1-1/2"	12-5/8"	10.7x17.5"	132	436.15
8600-3501	5	35"	8.5"	2"	2"	15"	14.6x25.4"	440	1,315.60

RATCHETING GEARS & REPLACEMENT RINGS FOR ARBOR PRESSES

- Original replacement parts.
- Ring & ratcheting gear sold separately.
- Fits HHIP brand ratcheting arbor presses.

For Arbor Press Type	Ratcheting Gear Item#	Price (F)	Retaining Ring Item#	Price (F)
2 Ton	8600-3302	29.24	8600-3303	14.20
3 Ton	8600-3402	32.56	8600-3403	23.26
5 Ton	8600-3502	35.81	8600-3503	26.71



REPLACEMENT SPINDLE FOR 2 TON RATCHET ARBOR PRESS

- Original replacement parts.
- Fits HHIP brand ratcheting arbor press.
- Fits arbor press item#8600-3301.

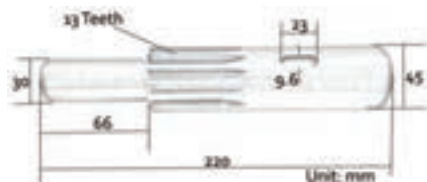

8600-3304
\$9280 (F)

Pro-Series ARBOR PRESSES

- For riveting, squeezing, punching, bending, and other pressing applications.
- Base drilled for mounting on bench or pedestal.
- Sturdy, cast-iron construction.
- Removable machined steel anvil provides accurate work support in four slot positions.
- Rugged steel ram is driven by machined pinion.

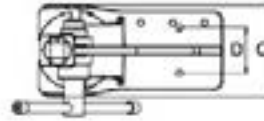
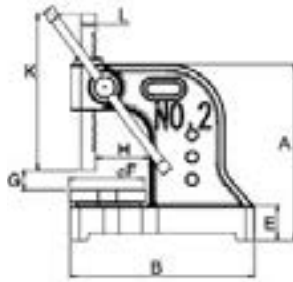

8600-1132 Shown

Item#	Press (Ton)	(MM)					Anvil Dia. F	Capacity Over Anvil G	H	K	Wt. (lbs)	Price (F)
8600-1130	1/2	A	B	C	D	E						
8600-1131	1	235	235	135	60	45	85	100	75	200	17	100.32
8600-1132	2	280	270	155	60	45	110	125	90	250	31	148.27
8600-1133	3	390	405	200	100	80	170	170	115	330	60	288.07
8600-1133	3	540	456	240	100	100	170	280	130	455	117	521.04
8600-1135	5	796	624	290	120	118	250	450	210	648	269	1,117.18

RATCHET 3TON ARBOR PRESS - Large Capacity

RATCHET TYPE

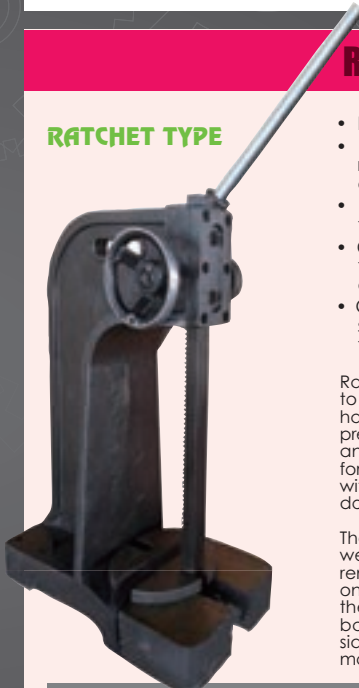

- Ratcheted lever lowers the ram to provide up to 3 tons of force.
- Handwheel quickly advances the ram for initial positioning, and the ratcheted lever lowers the ram onto the object and can be set at a comfortable position for the user.
- Smooth action gears enable fine control over ram movement with the lever.
- Counterweight repositions the lever to the top after a downstroke to reduce strain and quickly prepare for the next task.
- Open base and slotted table plate provide support for solid objects as well as an outlet for arbors and similar items to pass through.

8600-3603
\$916⁹⁷

Ratchet leverage arbor press with handwheel and counterweight applies up to 3 tons of force to facilitate installation, removal, and pressing of items. The handwheel advances the ram for quick placement near the object being pressed. The ratcheted lever lowers the ram onto the object with more precision and control than the handwheel and can be set at a comfortable position for the user. The smooth action gears enable fine control over ram movement with the lever, and a counterweight repositions the lever to the top after a downstroke to reduce strain and quickly prepare for the next task.

The open base and slotted table plate provide support for solid objects as well as an outlet for arbors and shafts to pass through. The plate can be removed or rotated to one of its 5 openings of varying diameters depending on the requirements of the application. The ram cap can be adjusted using the included 0.008" and 0.015" thick shims to adjust the ram forwards and backwards and to compensate for wear. The set screw adjusts the ram sideways. Three 0.52"-dia. holes are located on the base to enable bench mounting. Mounting hardware is not included. Press is assembled.

Item#	Press (Ton)	Max. Working Dia.	Max. Working Ht.	Throat Depth	(Inch) Press Ht.	Base Width	Base Depth	Ram	Leverage Ratio	Wt. (lbs)
8600-3603	3	14	17	7	27	10	21	1-1/4	48:1	145

PEDESTAL FOR ARBOR PRESS

- This arbor press floor pedestal is used with the Dake Model 1 or 1-1/2 (3 ton) arbor presses & our #8600-3603.
- Features slot to accommodate pieces that extend below the base.
- Anvil diameter word area 22-1/4".
- Weight: 70 lbs.
- Dimension(LxWxH): 12x21x36"

8600-3610
\$395²⁸



Pro-Series 3TON RATCHET LEVER ARBOR PRESS -LARGE CAPACITY

- 3 Ton capacity delivers the heavy force needed for riveting, squeezing, punching, bending, and other pressing applications.
- The Extra large clearance over the table allows for broaching or pressing larger items.
- It is counterweighted for a quick handle return and has a rapid ram feature that is advanced by using the press's convenient side-mounted handwheel.
- The rugged, reversible steel ram is driven by a machined piston, dimensions are 1-1/4 x 1-1/4 inches. Punches or tools may be added to the pre-drilled end of the ram with the aid of a magnetic insert. The three-bit set includes one-pointed bit, one round bit, and one square end bit along with a removable steel anvil.
- The removable 4-slotted anvil has a diameter of 8 inches.
- The Sturdy cast-iron base is pre-drilled for mounting on either a bench or pedestal (HHIP #8600-3610), and it is also machined to hold the included three-bit punch set.
- All parts are interchangeable with PALMGREN RP30.

RATCHET TYPE

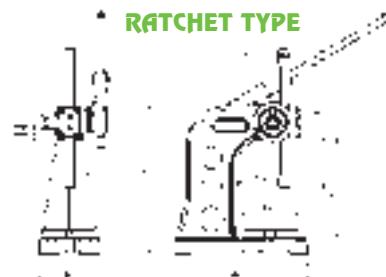

Item#	Capacity (Ton)	A	B	C	D	Ram E	Ram Punch Hole Dia.	G	Capacity Over Table H	Wt. (lbs)	Price (F)
8600-4401	3	21-1/4	9-7/8	27-3/4	7-13/16	1-1/4x1-1/4	1/2	6-7/8	17"	130	952.18

1-2-3 Blocks.....73-74, 216
 2-3-4 Blocks.....74
 2-4-6 Blocks.....74
 2-Jaw Chucks.....295
 3-Jaw Chucks.....285-287,
 290, 292-293, 295
 4-Jaw Chucks.....287-288, 294
 6-Jaw Chucks.....286, 290, 292
 40 Position Quick Change System...304

5C Tooling & Fixtures

Collets.....279-280
 Collet Bar Tool Holder.....299
 Collet Blocks.....237
 Collet Chucks.....234-236,
 279, 291
 Collet Rack.....279
 Emergency Collets.....280
 Fixtures.....276
 Indexer.....278
 Lathe Chucks & Mounts.....
 287-288, 290
 Spin Jig.....278
 Stops.....279
 Wrench.....279

A

A-Mount Back Plates.....294
 Acme Thread Gages.....31

Adapters and Arbors

Boring Head.....279-280
 BT.....225
 Circular Saw.....208
 Drill Chuck.....206, 222, 225
 End Mill.....126, 206, 208, 210,
 212, 213, 225, 226
 ER Holders.....207
 Expanding.....232, 282
 Grinding Wheel.....321-322
 Lathe Chuck.....289-292
 Milling Machine.....208
 Morse Taper.....208-211
 NMTB.....213-214
 R8.....207-208
 Revolving Tailstock.....306
 Slotting Saw.....208
 Stub.....208
 V-Flange.....221-223

Adjustable Blade Reamers...95
 Adjustable Dresser.....319
 Adjustable Link.....343
 Adjustable Parallels.....77
 Adjustable Round Split Dies..98
 Adjustable Tap & Reamer Wrenches..
 102
 Adjustable Tailstocks...269-270
 Adjuster, Magnetic Chuck Current...
 318

Air Accessories & Tools

Angle Grinders.....339-340
 Blow Guns & Kits.....338
 Connectors.....338, 341
 Collets.....340
 Drills.....340
 Filters & Regulators.....342
 Fittings.....341
 Grinders.....338-339

Guns.....338
 Impact Wrenches.....340
 Manifolds.....341
 Mufflers.....341
 Ratchet.....340
 Sander.....338
 Valves.....341
 Wrench.....340

Angle Blocks.....77, 81
 Angle Dressers.....316-317
 Angle End Mill Grinding Fixture...276
 Angle Gages.....29, 65
 Angle Grinders.....340-341
 Angle Plates.....77, 81-83, 268
 Angle Vises.....259, 265, 343
 Angle Vises, Welder's.....343
 Angle Lock Type Vises.....263
 Annular Cutters.....90
 Anvil Attachment Kits.....16
 Aprons.....342
 Arbor Presses.....354-356

Arbors

Drill Chuck.....168, 171,
 174, 181, 185, 198-199
 Expanding.....236
 Milling Machine.....170
 Revolving Tailstock (MT to JT)...242
 Slotting Saw.....116

Axial Support Bracket.....58

B

Backplates.....289-292, 306
 Ball Attachments, Micrometers...16
 Ball Nose End Mills.....114
 Ball Pein Hammers.....349
 Ball Plungers.....251
 Bars, Sine.....74
 Bases, Magnetic.....39-45
 Batteries.....10
 Bench Block.....345
 Bench Centers.....312
 Bench Grinders.....353
 Benders.....354
 Bevel Squares.....64
 Blade Micrometers.....23
 Blades, Cut-Off & Grooving...
 138-139, 141, 304
 Blind Hole Spotter Set.....348

Blocks

1-2-3, 2-3-4, 2-4-6.....27, 73-74
 Angle.....81
 Bench.....345
 Collet.....237
 Gages & Accessories...71-72
 Super Vee Block.....79
 Space.....74
 Test.....84
 V-Blocks.....79-80

Blow Guns.....336
 Bore Gages.....34
 Bore Gage Setting Master...34
 Boring Bars, Cobalt & Carbide
 Tipped.....121
 Boring Bars, Indexable...145-152
 Boring Bars, Double End...121

Boring Heads & Sets.....
 206, 244-248
 Boring Rings.....296
 Boring Shanks...202,245-246,248
 Boroscope, Video.....85
 Box & Pan Brake.....353
 Brake Dresser.....318
 Brass Hammers.....349
 Brazed Tool Bits & Sets.....119
 Broaches.....117-118
 Brown & Sharpe Collets.....212
 BT Tooling.....225-226, 234, 239
 Bull Nose Live Centers.....310
 Burrs, Carbide.....109

Bushings

Keyway.....118
 Tool Holder Sets.....281

C

Caliper Accessories.....10

Calipers

Batteries.....10
 Bluetooth.....4
 Caliper Cases.....10
 Dial.....7-9, 13
 Internal Dial Caliper Gage...48
 Depth Measuring Base...10
 Digital Electronic...1-6, 13-14
 Inside.....33
 Long Jaw.....5-6, 12
 Long Range.....4-6, 9, 12
 Outside.....33
 Plastic.....11
 Sets.....13-14
 Shock-Proof.....8
 Spring.....33
 Upper Jaws.....6
 Vernier.....11-13
 Waterproof.....3, 4, 6, 14
 Water Resistant.....2-4, 6

Cap Screw Counterbores...93
 Carbide Burrs.....109
 Carbide Drills.....88
 Carbide End Mills.....113

Carbide Inserts

A60.....195
 AG60.....195
 ANGX.....171
 APKT.....171
 CCGX.....171
 CCMT.....172
 CNMA.....172
 CNMG.....173-174
 CNMM.....175
 CPMT.....175
 Cut-Off.....136, 139, 199
 DCGX.....175
 DCMT.....175-176
 DNMA.....176
 DNMG.....176-178
 DPMT.....178
 Grooving...131, 134, 197-200
 GTN.....139, 199
 JCL.....143
 JCQ.....143
 KNUX.....178

Cases

Caliper.....10
 Gage Block.....71
 Micrometer.....16
 Pin Gage.....36

CAT ER Collet Chucks.....
 223, 234-236
 CAT End Mill Holders...221-222
 CAT Shell End Mill Holders...222
 CAT V-Flange Holders...221-222
 CBN Wheels.....320
 Center & Edge Finders...203-204
 Center Drills.....91
 Center Finder, Round Bar...63
 Center Keys.....243

MGMN.....138
 MRMN.....138, 200
 NOTCH.....135
 ONHU OCTAGON.....129
 RCKT.....178
 RCMT.....179
 RDKW.....179
 RNMG.....179
 SCMT.....179-180
 SD.....180
 SEAN.....180
 SEET.....180-181
 SEHT.....181
 SEKN.....181
 SNKN.....181
 SNMA.....181
 SNMG.....181-183
 SPG.....183
 SPKN.....184
 SPMR.....184
 SPMT.....184
 SPU.....184
 TCGX.....184
 TCMT.....185
 TDEX.....185
 TKEH.....136
 Threading.....
 131-132, 135, 195-198
 TNMA.....134, 186
 TNMC.....134, 186
 TNMG.....186-188
 TNMM.....188
 TPGB.....189
 TPGC.....189
 TPGH.....189
 TPGN.....189
 TPGW.....190
 TPKN.....190
 TPMC.....134
 TPMM.....190
 TPMR.....190
 TPU.....191
 TPUN.....191
 TT/TPMM.....190
 VBMT.....191
 VCMT.....192
 VCGX.....192
 VNMG.....192-193
 VNMS.....193
 WCMT.....193
 WCMX.....193
 WNMA.....194
 WNMG.....194-195

Cases

Caliper.....10
 Gage Block.....71
 Micrometer.....16
 Pin Gage.....36

CAT ER Collet Chucks.....
 223, 234-236
 CAT End Mill Holders...221-222
 CAT Shell End Mill Holders...222
 CAT V-Flange Holders...221-222
 CBN Wheels.....320
 Center & Edge Finders...203-204
 Center Drills.....91
 Center Finder, Round Bar...63
 Center Keys.....243

Center Line Gages.....10
 Center Gages.....30, 203
 Center Punch.....346
 Centered V-Magnet.....42
 Centering Indicators.....57

Centers

Bench.....312
 Dead.....306
 Live.....307-311

Chamfering Tools.....122
 Chuck Wrenches.....294
 Chucking Reamers & Sets...94

Chucks

CAT40.....223
 5C Collet...234, 236, 279, 291
 ER.....206-207, 223, 233-235
 Drill.....207, 225
 Lathe.....270, 275, 285-295
 Magnetic.....323-324
 Rotary Indexes.....271
 SK (Lyndex Style).....238

Circular Saw Arbors.....208
 Clamps, Dovetail.....59
 Clamping Kits.....249, 251-252
 Clamping Studs.....250
 Clamps for Indexable Tools..166
 Clamps, Hold Down.....252
 Clamps, Toggle.....254-258
 Claw Hammer.....349
 Clutch Collets.....278
 Collet Blocks.....237
 Collet Chucks.....
 210, 212, 214, 226, 233-235
 Collet Fixtures.....237, 278
 Collet Racks.....205-206, 279

Collets

5C.....278-280
 Air Tools.....340
 Brown & Sharpe.....212
 Chucks...206-207,210,233-237
 Clutch.....278
 Emergency (5C)280
 Expanding.....278
 ER.....227-230
 Flex, Tap.....103
 Hex (5C).....280
 Metric.....205, 227-228, 280
 Morse Taper.....209
 R8.....205
 Racks.....205-206, 232, 279
 Round.....278-280
 Rubber Flex.....103
 SK-10 & SK-16.....238
 Sleeves.....234
 Spring.....227-230
 Square.....280
 Step.....278

Collet Fixtures.....276
 Collet Indexer (5C).....278
 Collet Stops.....278-279
 Collet Wrenches.....231-232
 Combination Squares.....62
 Combination Wrenches...350
 Combined Drill & Countersinks...91

Comparators

Height Presetter.....	215-216
Optical.....	86
Compound Angle Plate.....	81
Compound Milling Tables.....	267
Compound Slide Tables.....	267
Concentricity Checker.....	313-314
Convex Radius Milling Cutters.....	114
Coolant Hose Kits.....	334-335, 337
Coolant Hose Wrenches.....	337
Coolant Pump Kit.....	335-336
Connectors, Coolant.....	337
Console, Digital.....	202
Controller, Magnetic Chuck.....	318
Counters.....	349
Counterbores.....	92, 93
Countersinks.....	91-93, 108, 122
Coupling Nuts.....	250-251
Couplers, Air.....	338
Cross Slide Visers.....	259
Cup Wheels.....	320
Current Adjuster, Magnetic Chuck.....	318
Cut-Off Blades.....	141, 304
Cut-Off Blades/Indexable.....	138-140
Cut-Off Inserts.....	138-140
Cut-Off Tool Holders.....	139-140, 304
Cut-Off Wheel Mandrel.....	339

Cutters & Saws

Annular.....	90
Chamfering.....	115
Disc.....	345
Double Angle Shank.....	115
Convex Milling.....	114
Convex Radius.....	114
Fly.....	120, 211
Gear.....	116
Plain Metal Slitting.....	116
Single Angle Chamfering.....	115
T-Slot.....	115
Woodruff Keyseat.....	118

Cylindrical Squares.....	64
--------------------------	----

D

D Mount Back Plates.....	291
D Mount Direct Mount Chucks.....	293-294
Dead Blow Hammers.....	349
Dead Centers.....	306
Deburring Tools.....	107-108
Deep Throat Micrometers.....	20
Demagnetizers.....	344
Depth Gages & Accessories.....	25-26
Depth Micrometers.....	25-26
Dial Bore Gages.....	34
Dial Calipers.....	7-9, 13
Dial Height Gages.....	67
Dial Indicators.....	13, 45, 47-51
Dial Protractor.....	60
Dial Test Indicators.....	13, 45, 54-56
Diamond Dressers.....	319
Diamond Needle Files.....	108
Diamond Pin Set.....	108
Diamond Wheels.....	320
Die Grinders.....	338-340

Die Holders.....	102
Die Sets.....	97-98
Die Stocks.....	102
Diemakers Square.....	64
Dies.....	97-98
Digital Electronic Calipers.....	1-6, 13-14
Digital Electronic Display.....	201-202
Digital Electronic Readout Scales.....	201
Digital Electronic Height Gages.....	68-69
Digital Electronic Indicators.....	45, 51-52
Digital Electronic Micrometers.....	21, 24, 26, 28
Digital Electronic Multimeters.....	353
Digital Electronic Protractor.....	61
Digital Electronic Thickness Gage.....	26
Disc Cutter Set.....	345
Dividers.....	33
Dividing Fixture, Wire EDM.....	330
Dividing Heads.....	274-275
Dividing Plates.....	268-270, 273
Double Angle Shank Cutters.....	115
Double End Boring Bars.....	121
Double Square.....	62
Dovetail Cutters.....	123
Drawbars.....	203
Drawbar Hammer.....	201

Dressers

Adjustable Diamond.....	319
Brake Truing.....	318
Diamond.....	319
Radius & Angle.....	316-317
Sine Dresser.....	317
Universal Wheel.....	316
Drift Keys.....	243
Drift Tool, Hand Dayton Style.....	209

Drill Chucks & Accessories

Arbors.....	206, 222, 225
Ball Bearing.....	241
Drill Chucks with Key.....	225, 241
Hand Drill Feed.....	240
Keyless Drill Chucks.....	207, 211, 221, 225, 239-240
Pin Chuck Set.....	242
Pin Vise Set.....	242
Replacement Keys.....	241
Wedge Sets.....	242
Wrenches.....	240
Drill Press Visers.....	259-260
Drilling Tables.....	267

Drills

Air.....	340
Annular.....	90
Carbide.....	88
Center.....	91
Cobalt.....	87-89
Jobber Length.....	87-89
Metric.....	87-89
NC Spotting.....	87
Sets.....	87
Silver & Demming.....	89

Solid Carbide.....	88
Spotting.....	87
Step.....	94
Tap & Drill Set.....	88
Taper Shank.....	89
Wire Gage.....	87

Drill Press Center Finder.....	203-204
Drive Pin Punch Sets.....	346
Dovetail Clamps.....	59
Dykem.....	343

E

Edge and Center Finders.....	204
Electrical Tape.....	342
Electronic Digital Caliper.....	1-6, 13-14
Electronic Digital Depth Gages.....	26
Electronic Digital Indicators.....	45, 51-52
Electronic Digital Height Gages.....	68-69
Electronic Digital Micrometers.....	21, 24, 26, 28
Emergency Collets (5C).....	280
End Mill Grinding Fixture.....	276
End Mill Holders.....	126, 206, 208, 210, 212-213, 225-226

End Mills

AlTiN Coated.....	110-113
Ball Nose.....	114
Carbide.....	113
Center Cutting.....	111-114
Chamfering.....	122
Cobalt.....	111-114
Corner Rounding.....	110
Double End.....	110-111
Fine Pitch.....	113
High Speed Steel.....	110-112, 114
Indexable.....	122, 124-128
Miniature.....	111
Roughing.....	113
Sets.....	110, 114
Single End.....	110, 112
Square Shoulder.....	128
Titanium (TiN) Coated.....	110-113

ER Tooling

BT.....	226, 233-236
CAT40.....	223, 234-236
Collets.....	221-230
Collet Blocks.....	237, 276
Collet Chucks.....	223, 233-235
Collet Fixtures.....	237, 291
Collet Racks.....	232
Fixtures.....	237
Morse Taper.....	210, 234-236
NMTB.....	213-214, 233, 235-236
Nuts.....	231
Punch Formers.....	315
R8.....	233, 235-236
Replacement Nuts.....	231
Straight Shanks.....	233, 235-236
Wrenches.....	231-232

Exhaust Mufflers.....	341
Expanding Arbors.....	232, 282
Expanding Collets.....	278
Expanding Mandrels.....	282
Extractors, Screw.....	109

F

Face Mill Holders.....	212
Face Mills.....	126-130
Face Mill Screws.....	165
Feeds, Power Table.....	202
Files, Riffler, Needle & Steel.....	108
Filter/Regulator/Lubricator Units.....	342

Finders

Center.....	203-204
Edge.....	204
Round Bar Center.....	63

Fittings

NPT Sintered Bronze Exhaust Mufflers.....	341
Push to Connect.....	341
Fixture, EDM Dividing.....	330
Fixtures, Tightening.....	215, 221, 224
Flanged Nuts.....	250-251
Flanges, Grinding Wheel.....	321-322
Flexible Arm Magnetic Bases.....	42
Floating Die Holders.....	102
Fly Cutters.....	120, 211
Frame Levels.....	66

G

Gage Block Set Repl. Cases.....	71
Gage Blocks & Accessories.....	71-72
Gage Handles.....	36

Gages

Angle.....	29, 65
Bore, Dial.....	34
Bore Gage Setting Master.....	34
Center.....	30, 203
Center Line.....	10
Convex & Concave.....	29
Depth.....	25-26
Dial Thickness.....	26
Electronic.....	26
Height.....	67-69
Internal Caliper.....	33
Monoblock Depth Vernier.....	25
Multipurpose, 7-in-1.....	30
Pin/Plug.....	35-38
Planer and Shaper.....	81
Radius.....	29
Screw Pitch.....	31
Screw Thread ACME.....	30
Small Hole.....	33
Surface.....	70
Surface Specimens.....	84
Surface Roughness.....	84
Telescoping.....	32-33
Thread & Ring Gages.....	31
Thickness.....	26
Wire Measuring.....	16, 30

Gears & Rings for Arbor Presses.....	355
Giant Slotted Angle Plates.....	83
Granite Checks.....	43
Granite Squares.....	64
Granite Surface Plate Stands.....	70
Granite Surface Plates.....	70

Grinders

Angle.....	339
Air.....	338-339

Bench.....	353
Punch.....	315
Stand.....	353

Grinding Driving Carriers.....	319
Grinding Fixture.....	276
Grinding Wheel Adapters.....	321-322
Grinding Wheel Dressers.....	319
Grooving Tool Holders.....	133-137

H

Half-Round Combination Holder.....	58
Halogen Work Lights.....	332
Hammer / Wrench.....	201
Hammers.....	349
Hand Notcher.....	354
Hand Tappers.....	101, 103-104
Hand Taps.....	96-97

Handles

Ball Knobs.....	351
Machine Levers.....	351
Pin Gage.....	36
Quill Feed Adapter.....	202
Quill Feed.....	201
Vise.....	263

Hard Jaws for Lathe Chucks.....	261-262
Hardness Tester & Accessories.....	84
Height Gage Clamps & Scribes.....	59
Height Gage Attachment.....	59, 67-69
Height Gages.....	67-69
Helicoil Style Thread Repair Kits.....	105-106
Hex Collets.....	280
Hex Dies.....	97-98
Hex Nuts.....	250
Hex Wrenches.....	165
Hi Spot Blue.....	343
Hoist Rings.....	352
Hole Mike Sets.....	28

Holders

Magnetic.....	39-45
End Mill.....	214, 221-222, 226
Indicator.....	39-43
Hold-Down Clamps.....	252
Hole Spotter Set.....	348
Horizontal & Vertical Collet Indexer.....	278
Hoses, Coolant.....	337
HSK ER Collet Chucks.....	212
HSK Face Mill Holders.....	212

I

Impact Wrenches.....	340
----------------------	-----

Indexable Tooling

Boring Bars.....	145-152
Carbide Insert.....	See Carbide Inserts
Countersinks.....	122
Cut-Off Tools.....	139-141, 143
Dovetail Cutters.....	123
End Mills.....	122, 124-128
Face Mills.....	126, 130
Grooving Holders.....	133-137
Integral Shank.....	140
Parting.....	137

INDEX

Spare Parts.....165-166
T-Slot.....123
Threading Tools.....132-137
Turning Tools.....
.....119, 132, 142-144, 153-164

Indexer, 5C.....278
Indexer, Rapid.....271
Indexing Fixtures.....273
Indexing Fixture, Rotary.....273
Indexing Quill Feed Handles...201
Indexing Spin Jigs.....277-278
Indicating Micrometers.....23

Indicator Accessories

Axial Support Bracket.....58
Back Covers.....48
Clamps.....58-59
Contact Points.....46
Conversion Point.....46
Extension Points.....46
Holders.....42-43, 58
Interapid Type Parts.....55
Magnetic Backs.....42, 44
Point Sets.....44, 46
Sets.....44-45, 58
Stands.....42-43
Universal Arms.....58

Indicators

Back Plunge46
Centering.....57
Dial.....44-45, 47-50
Dial Test.....45, 54-55
Dial with Lifting Lever.....48
Digital Electronic.....45, 51-52
Double Range Dial Test.....56
Large Face.....54
Long Range.....55-56
Metric.....47, 50, 55
Sets.....13-14
Short Range.....46
Travel.....44-51
Test.....54-56
Vertical.....55
Waterproof.....48

Inserts, Carbide.....
.....See Carbide Inserts
Inserts, Thread Repair.....105-106
Inside Micrometers.....27-28
Inspection Parallels.....25
Inspection Tool Kits.....13-14
Integral Shank Drill Chucks.....
.....207, 211, 214, 225, 239-240

J

Jacks Machinists.....253
Jack Screw Set.....253
Jacobs Taper Arbors...206, 222, 225
Jaw Nuts & Screws.....296
Jaws, Lathe Chuck...290, 297-298
Jaws/Vise.....261-262
Jobber Length Drills.....87

K

Keyless Drill Chucks.....239-240
KDK Style Quick Change Holders..
.....299-300

Keys

Drift/Center.....243
Drill Chuck.....241
Hex.....165
Lathe Chuck.....294
Torx.....350

Keyway Broaches/Bushings..117-118

Knobs

Hand.....351
Toggle.....217-220

Knurling Tools & Knurls.....305

L

L Mount Backplates.....291
Lamps.....See Lights
Latch Toggle Clamps...254-258
Lathe Centers.....306-311

Lathe Chucks

2-Jaw.....295
3-Jaw.....
.....270, 275, 285-287, 290, 292-293, 295
4-Jaw.....287-288, 294
6-Jaw.....286, 292
5C Mount...287-288, 290-291
Backplates.....289, 291-292
Collet Chucks.....291
Front Mount.....275
Independent.....288, 294
Jaw Boring Rings.....296
Jaw Nuts & Screws...296
Morse Taper Mount.....290
Power.....295
Self-Centering.....
.....270, 275, 285-287, 290, 292-293
Replacement Jaws.....
.....290, 296-298
Wrenches.....294
Zero-Set292

Lathe Mandrels.....282

LCD Display.....201-202

LED Machine Lamps...331-333

Letter Stamps.....345

Leveling Mounts.....203

Levels.....66

Lights

Halogen.....85
LED Machine Lamps...85, 331-333
Magnetic Base Lamps...331
Microscope Lamps.....85
Waterproof.....85, 331

Linear Scales.....201-202

Live Centers.....306-311

Lock & Shim Pins.....166

Long Travel Indicators...55-56

M

Machine Counters.....349

Machine Lamps.....331-333

Machinery Mounts.....203

Machinist Squares.....63

Machinist's Jacks.....253

Machinist's Vises.....265

Magnetic Backs, Indicator...42, 44

Magnetic Bases.....39-45

Magnetic Chuck Parallels...318

Magnetic Chuck Controller...318

Magnetic Chuck Current Adjuster...318

Magnetic Chucks.....323-324

Magnetic Parallel Set...78, 80

Magnetic Sine Bar.....324

Magnetic Sine Plate.....324

Magnetic V Blocks.....80, 324

Magnetizer / Demagnetizer...344

Magnets & Holders.....343

Magnifiers.....85-86, 331-332

Mandrels

Cut-Off Wheel.....339
Expanding.....282
Lathe.....282

Manifolds.....342

Markers, Industrial.....343

Master Precision Levels...66

Measuring Sets/Kits.....60

Metric Drills.....87-89

Metric Taps.....96

Micro Checking Sets.....15

Micrometers

Accessories.....15-16
Anvil, Interchangeable...20
Ball Spherical Face.....21
Blade.....23
Deep Throat.....20
Depth.....25-26
Digital.....20
Electronic Digital.....
.....21, 24, 26, 28
Heads.....20
Indicating.....23
Inside.....27-28
Metric.....19
Outside.....17-19, 24
Pointed Spindle & Anvil...22
Screw Thread.....21
Sets.....13-14, 17-19
Vernier Spline.....22

Micrometer Accessories

Anvil Attachments.....16
Ball Attachments.....16
Bases & Stands.....39-42
Metal Cases.....16
Stands.....16, 24
Thread Triangle.....15

Micrometer Measuring Masters...16

Micrometer Stands.....16, 24

Microscopes.....85-86

Mig Welding Pliers.....345

Milling and Drilling Tables...267

Milling Cutters.....114

Milling Machine Arbors...208

Milling Machine Draw Bars...203

Milling Vises.....263-265

Mirror, Inspection.....285

Mist Coolant Units.....334-337

Mity-Mag Indicator Holder...42, 44

Morse Taper Tooling

CAT40.....222, 234

Collets.....209

Collet Chucks.....210, 234-236

Dead Centers.....306

Die Holders.....211

Drill Chucks & Arbors...209, 211

End Mill Holders.....210

Extension Sockets.....209

Lathe Chucks.....290, 306

Live Centers.....307-311

R8.....209

Revolving Tailstock Backplates...306

Revolving Tailstock Chuck Adapter...
.....211

Sleeves.....209, 243

Tail Stock Turret.....290, 306

Mounts, Machine.....203

Mufflers, Exhaust.....341, 353

Multimeters.....353

N

NC Spotting Drills.....87

Needle Files.....108

NMTB Drill Chuck Arbors...213

NMTB End Mill Holders...213

NMTB ER Collet Chucks.....
.....213-214, 233, 235-236

Notchers.....354

Number Stamps.....345

Nuts

Coupling.....250-251
Flange.....250-251
Heavy Duty Hex.....250
Jaw Nuts & Screws...296
T-Slot.....250-251

O

Optical Comparator.....86

Optical Punch Set.....90, 345

Outside Micrometers...17-19, 24

P

Pan & Box Brakes.....353

Parallels & Sets.....75-77, 80

Parallel Cut-Off Blades...141, 304

Parting Tools.....137-141

Parts for Turning Tool Holders...
.....165-166

Permanent Magnetic Chucks...
.....323-324

Pilot Counterbores.....93-93

Pin Chuck Set.....242

Pin Vise Set.....242

Pin Gage Cases.....36

Pin/Plug Gages.....35-38

Pin/Plug Handles.....36

Pin Punches.....346

Pipe Dies.....97

Pipe Taps.....97

Pipe Jaws/Lathe...291, 296-298

Pipe Reamers.....94

Planer & Shaper Gage.....81

Plates, Angle.....81-83, 268

Pliers, Welding.....343

Plug Gages.....35-38

Plungers, Ball.....251

Pocket Comparator.....86

Point Sets, Dial & Test Indicator...
.....44, 46

Power Chucks.....295

Power Table Feeds.....202

Presetters.....215

Presses, Arbor.....354-356

Protractors.....60-62, 65

Pumps, Coolant.....335-336

Punch Formers.....315-316

Punch Grinders.....315

Punches.....344, 346-348

Q

Quick Change Tool Posts,
Holders & Sets.....299-304

Quick Clamp for Mill Vise...262

Quick Clamp Work Stop...262

Quick Coupler.....338

Quill Feed Adapter.....202

Quill Feed Handles.....201

Quill Stops.....201

Quill Indicator Holder.....58

R

R8 Collet Racks.....205-206

R8 Tooling

Collet Chucks...207, 235-236

Collets.....205

Drill Chucks & Arbors...206-207

End Mill Holders.....206, 208

ER Holders & Sets.....
.....207, 233, 235-236

Indexable End Mill.....124

Morse Taper Sleeves...209

Right Angle Attachment...203

Saw Arbor.....208

Rack, Transfer Punch.....348

Radius Dressers.....316-317

Radius Gages.....29

Ratchet Arbor Presses...354-356

Ratchet & Tap Handles...102

Ratchet Wrench.....340

Readout Scales, Digital...201

Reamers.....94-95

Refractometers.....335

Regulators.....342

Replacement Draw Bar...203

Retention Knobs.....217-220

Revolving Tailstock Backplates...
.....290

Riffler File Set.....108

Right Angle Attachments.....
.....81-83, 203, 268

Right Angle Plates.....77

Ring Gages.....31

Rings, Boring.....296

Rings, Hoist.....352

Rockwell Hardness Tester...84

Rotary Chucks.....271

Rotary Indexer.....271

Rotary Table Flanges.....270

Rotary Tables.....268-272

Roughing End Mills.....113

Roughness Standards.....84

Round Head Protractors...60

Round Tool Bits.....120

Rules.....60

S

Safety Shields.....334

Sander.....338

Saws & Cutters

Convex Milling.....	114
Convex Radius.....	114
Double Angle Shank.....	115
Fly.....	120
Gear.....	116
Plain Metal Slitting.....	116
Single Angle Chamfering.....	115
Woodruff Keyseat.....	118

Saw Arbor, Slotting.....	116
Scales/Electronic.....	201-202
Scales/Rules.....	60
Scales/Linear.....	201-202
Scraper Set.....	100
Screw Bolts (Quick-Change).....	299, 302
Screw Extractors.....	109
Screw Jacks.....	253
Screw Pitch Gages.....	31
Screw Thread Micrometers.....	21
Screwless Vises.....	325

Screws

Jaw Nuts & Screws.....	296
Shell End Mill Holder.....	222
Tang for Drawbar End Holders.....	230

Scribers.....	346
Sensitive Hand Drill Feed.....	240
Shears.....	354

Sheet Metal Equipment

Benders.....	354
Brakes & Shears.....	354
Notcher.....	354
Pan & Box Brakes.....	353

Shell End Mill Holders.....	126
Shell End Mill Screws.....	222
Shields, Safety.....	334
Shim Pins.....	166
Shims.....	117, 166
Shop Apron.....	342
Shop Microscope.....	85-86
Silver & Deming Drills.....	89
Sine Bars.....	74
Sine Dresser.....	317
Sine Plates.....	81
Sine Vises.....	326, 328
Single Angle Chamfering Cutters.....	15
SK (Lyndex Style) Holders, Collet Chucks, Nuts & Sets.....	238
Sledge Hammer.....	349

Sleeves

Morse Taper.....	209, 243
R8 to Morse Taper.....	209

Slotted Angle Plates.....	83
Slotting Saw Arbor.....	208
Small Hole Gages.....	33
Sockets, Extension.....	209
Soft Jaws Lathe Chucks.....	290, 296-298
Soft Jaws for Vises.....	261-263
Solid Carbide Drills.....	88
Solid Carbide End Mills.....	113
Space Blocks.....	74
Spanner Wrenches.....	351
Specimens.....	84

Spin Jigs.....	277-278
Spindle Assemblies.....	255
Spindle for Arbor Press.....	355
Spindle Sqaure.....	203
Spindle Wipes.....	230
Spiral Taps.....	96
Spotters, Blind Hole.....	348
Spotting Drills.....	87
Spring Calipers & Dividers.....	33
Spring Collets.....	227-230
Springs.....	166
Square Head Protractors.....	60-62
Square Shoulder End Mills.....	128
Square Tool Bits.....	120

Squares

Bevel.....	64
Center Square.....	63
Combination.....	62
Cylindrical.....	64
Diemakers.....	64
Double.....	62
Granite.....	64
Machinist.....	60, 63
Solid.....	63
Spindle.....	203

Stamping Sets.....	345
--------------------	-----

Stands

Arbor Press.....	356
Bench Grinder.....	353
Granite Surface Plates.....	70
Indicator.....	42-43, 58
Micrometer.....	16

Steel Files.....	108
Steel Parallels.....	75-77
Step Collets.....	278
Step Drills.....	108
Stepped Angle Plates.....	82
Stereo Microscopes.....	85-86

Stops

Collet.....	278-279
Milling Vise.....	262
Quill.....	201
Work.....	262

Stub Milling Machine Arbors.....	208
Student Inspection Kit.....	13
Studs, Clamping.....	250
Super V Block.....	79
Super Spacer.....	273
Surface Plates, Granite.....	70
Surface Roughness Standards.....	84
Surface Specimens.....	84
Swivel Angel Plates.....	82
Swivel Clamps.....	59

T

T-Nut Blanks.....	299
T-Slot Bolts.....	250-251
T-Slot Clamping Kits.....	252
T-Slot Cleaner.....	252
T-Slot Cutters.....	123
T-Slot Nuts.....	250-251
Table Feeds.....	202

Tables

Compound Slide.....	267
Cross Slide.....	267
Milling and Drilling.....	267
Rotary.....	268-273
Tilting.....	268, 272

Tailstock Turrets.....	306
Tailstocks Rotary Table.....	269-270, 273
Tang Screws.....	230
Tangent Bar & Angle Block.....	77
Tap Wrenches.....	101
Tap Wrench Extensions.....	101
Tap & Drill Sets.....	88, 106
Tap & Die Sets.....	97, 99-101
Tape.....	342
Tape Measures.....	344
Taper Pipe Reamers.....	95
Tappers.....	101, 103-104
Tapping Guide.....	101-102
Tapping Heads.....	103
Taps.....	96-97
Tap Collets.....	103
Tap Holders.....	101-104
Telescoping Gages.....	32-33
Test Indicators.....	54-56
Thickness Gages.....	26
Thin Parallels.....	75-76

Thread Detective / Identifier.....	30
Thread Plug & Ring Gages.....	31
Thread Repair Kits.....	105-106
Thread Restoring Tool.....	108
Thread Triangle.....	16
Thread Wire Insert Installation Tool.....	106
Thread Wire Measuring Sets.....	16
Threaded Backplates.....	289
Threading Inserts & Grooving Inserts.....	131
Threading Tool Holders.....	132-137
Tie Downs.....	349
Tightening Fixtures.....	215, 221, 224
Tilt/Swivel Vises.....	259
Tilting Tables.....	268, 272
Toggle Clamps.....	254-258
Tool Bits.....	119-120
Tool Holder Bushings.....	281

V-Blocks

Aluminum Cast.....	80
Magnetic.....	80
Cast Iron.....	80
Elongated.....	79
Four-Way.....	79
Granite.....	80
Multi-Use.....	78
Stainless Steel & Steel.....	78-79
Toolmaker's.....	78
Triple "V".....	79
V-Blocks & Clamps.....	78
Vee Blocks.....	79
Ultra Precision.....	78

V-Flange Tooling

Collet Chucks.....	222-223
Drill Chuck Arbors.....	243
Drill Chuck.....	221-222
End Mill Holders.....	221
ER Holder.....	223
Morse Taper.....	222
Retention Knobs.....	217-220
Shell Mill.....	222
Tool Setting Fixture.....	221

Valves, Coolant.....	337
Vernier Calipers.....	11-13
Vernier Height Gage.....	67

Tool Holders

Boring.....	142-143, 145-152
Cut-Off & Grooving.....	139-141, 143
Grooving.....	133-137, 198-199
Integral Shank.....	140
Parting.....	137
Threading.....	132-137, 198-199
Turning.....	119, 132, 142-144, 153-164

Tool Posts & Sets

40 Position.....	304
Aloris Type.....	301-303
KDK Style.....	299-300
Miniature Sets.....	304
Quick Change Tool Posts/Sets.....	301-304
Toolmaker's Vises.....	325-329
Top Notch Style Tooling.....	135
Torque Wrenches.....	350
Torx Keys.....	350

Transfer Punches.....	348
Transfer Screws.....	347
Truing Dressers.....	318
Tube Notcher.....	354
Turning Tool Holders.....	119, 132, 142-144, 153-164
Turning Tool Sets.....	119-121
Turrets, Tailstock.....	306
Twin-Lock Vises.....	265
Tool Holder Bushings.....	281

U

Universal Angle Blocks.....	77, 81
Universal Extension Arms.....	58
Universal Bender.....	354
Universal Wheel Dresser.....	316

V

V-Angle Plates.....	82
---------------------	----

V-Blocks

Aluminum Cast.....	80
Magnetic.....	80
Cast Iron.....	80
Elongated.....	79
Four-Way.....	79
Granite.....	80
Multi-Use.....	78
Stainless Steel & Steel.....	78-79
Toolmaker's.....	78
Triple "V".....	79
V-Blocks & Clamps.....	78
Vee Blocks.....	79
Ultra Precision.....	78

V-Flange Tooling

Collet Chucks.....	222-223
Drill Chuck Arbors.....	243
Drill Chuck.....	221-222
End Mill Holders.....	221
ER Holder.....	223
Morse Taper.....	222
Retention Knobs.....	217-220
Shell Mill.....	222
Tool Setting Fixture.....	221

Valves, Coolant.....	337
Vernier Calipers.....	11-13
Vernier Height Gage.....	67

Vises

2-Way Swivel.....	265
Angle.....	259, 265, 343
Angle Tight.....	264
Centering.....	266
Cross Slide.....	218
Double Lock Type.....	263-265
Drill Press.....	259-260
EDM.....	327-328, 330
Machine (Horiz./Vert.).....	265
Machinist's.....	265
Milling.....	263-265
Pin.....	242
Quick Clamp Mill.....	260, 265
Rotary Table.....	268, 273
Screwless.....	325, 328
Screw Type.....	328-329
Self Centering CNC.....	224
Sine.....	326, 328
Stainless Steel.....	327-330

Super Lock.....	264
Swivel.....	326
Tilt.....	259, 326
Toolmaker's.....	325-329
Twin-Lock CNC.....	265
Universal Mount.....	326
Welder's.....	343

Vise Accessories

Adjustable Tailstock.....	269, 273
Dividing Plates.....	269, 273
Handles.....	263
Jaw Block.....	263
Jaws.....	261-262, 263
Mill Stop.....	262
Speed Handle.....	263
Swivel Bases.....	263
Work Stop.....	262
Worm Gear & Metal.....	273
VisiDresser.....	316

W

Wavy Parallels.....	77
Wedge Sets for Chucks.....	247
Wheel Dressers.....	316
Wheels, CBN.....	320
Wheels, Diamond.....	320
Wiggler/Center Finder.....	204
Wipes, Spindle.....	230
Wire Gage Drill Sets.....	87
Wire Measuring Gages.....	16, 30
Welder's Pliers.....	343
Work Lights & Magnifiers.....	331-333

Wrenches

5C Collet.....	279
Adjustable Face Spanner.....	351
Air.....	340
Combination.....	350
Coolant Hose.....	337
Drawbar.....	203
Drill Chuck.....	240
ER Collet.....	231-232
Hammer / Wrench Combo.....	201
Hex.....	165
Impact.....	340
Lathe Chuck.....	294
Tap & Reamer.....	102
Torque.....	350
Torx.....	165

X

XYZ Table Feeds.....	202
----------------------	-----

Z

Z-Axis Setters.....	215-216
Zero-Set Lathe Chucks/Backplates.....	292



▶ **PRECISION MEASURING TOOLS**

▶ **CARBIDE INSERTS**

▶ **CUTTING TOOLS**

▶ **MACHINE TOOL ACCESSORIES**

▶ **MRO & SHOP SUPPLIES**

▶ **AIR, POWER & HAND TOOLS**
